



VOLUME 32

www.wisdomplaygrounds.com



WISDOM PLAYGROUNDS

1335 Cedar Hill Rd. Unit 8. Navassa, NC 28451
www.wisdomplaygrounds.com
910.769.3576

PROMOTING CHILDREN'S PHYSICAL AND INTELLECTUAL DEVELOPMENT THROUGH ACTIVITY!



007

WisePlay Quick Ship

WisePLAY Quick Ship
WisePLAY Inclusive Quick Ship
WiseTOT Quick Ship
WiseNEX Quick Ship
WiseFREE Quick Ship
WiseSITE Quick Ship

059

WiseTOWER

WiseTOWER Summit Series
WiseTOWER SkyTower series

073

WiseTOT

WiseTOT Lean on Me Series
WiseTOT Custom
WiseTOT Retro Play & GO

093

WisePLAY

WisePLAY Inclusive
WisePLAY Custom
WisePLAY Theme

151

WiseMAX

WiseMAX Inclusive
WiseMAX Custom
WiseMAX Theme

ABOUT US

For over 31 years, Wisdom Playgrounds has been a trusted name in delivering exceptional commercial playground solutions. Based in Navassa, NC, we are dedicated to providing top-tier customer service and high-quality, inclusive play equipment that inspires fun, fosters growth, and serves children of all abilities. Our mission is to help communities create safe, engaging spaces where children can explore, learn, and play together.

What truly sets us apart is our industry-leading Quick Ship program. With a selection of over 80 pre-designed modular structures and a wide range of stocked components, we offer the fastest delivery times in the industry. Most Quick Ship orders are prepared and ready to ship in as little as 3-5 days. For those seeking something more unique, we make it easy to customize your playground by incorporating additional stocked items into your Quick Ship order. This combination of speed and flexibility ensures you get the perfect solution tailored to your community's needs without unnecessary delays.

Our commitment goes beyond fast shipping and innovative designs. We're passionate about creating inclusive play environments that bring joy to children of all abilities while meeting the highest safety and quality standards. Whether you're planning a fully customized playground or need a quick and reliable solution, Wisdom Playgrounds is your trusted partner in building vibrant, imaginative, and durable play spaces.



3.5 QS WisePLAY QUICK SHIP	3.5 QS WiseTOT QUICK SHIP	3.5 QS WiseNEX QUICK SHIP	3.5 QS INCLUSIVE QUICK SHIP	QS WiseFREE QUICK SHIP	QS WiseSITE QUICK SHIP	
3.5 WiseTOT	3.5 WisePLAY	3.5 WiseTower	5.0 WiseMAX	 WiseFIT	 WiseWORX	 NatureWISE
 Standard	 Inclusive	 TreeHouse	 Castle	 Pirate Ship	 Nature	
3.5 3.5" Post	5.0 5.0" Post	 ADA	26-30 Capacity	 Activities	 Surface Mount	 In-Ground



3-5 DAYS

Quick Ship

Our Quick Ship items offer an industry-leading 3-5 day turnaround, ensuring you get high-quality playground solutions fast. Perfect for tight project timelines, these pre-designed modular structures are an ideal fit for small to medium play areas, delivering fun and functionality without the wait.

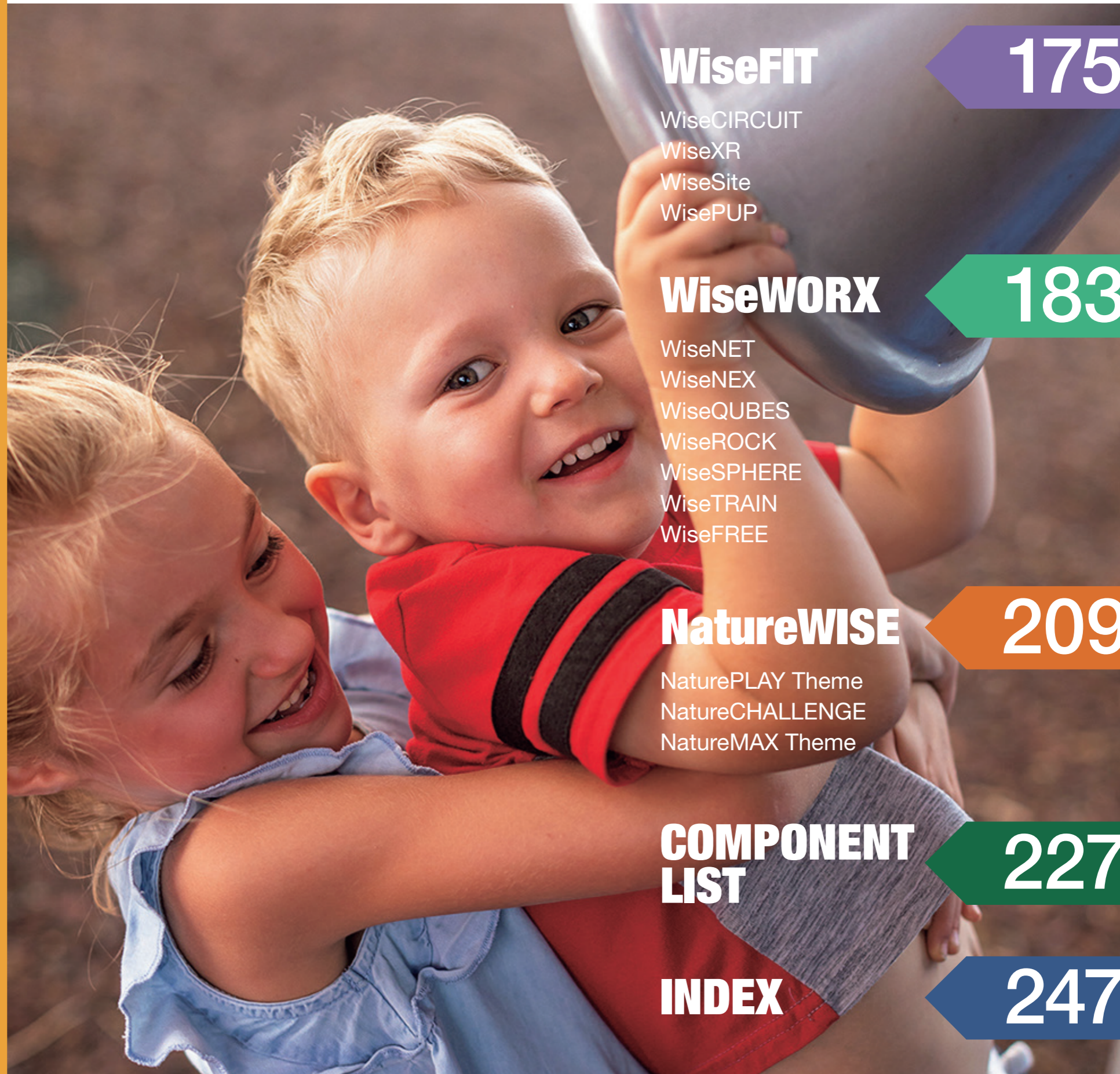

WiseFIT

175

- WiseCIRCUIT
- WiseXR
- WiseSite
- WisePUP

WiseWORX

183

- WiseNET
- WiseNEX
- WiseQUBES
- WiseROCK
- WiseSPHERE
- WiseTRAIN
- WiseFREE

NatureWISE

209

- NaturePLAY Theme
- NatureCHALLENGE
- NatureMAX Theme

COMPONENT LIST

227

INDEX

247

WHAT MAKES WISDOM DIFFERENT

ADVANTAGE COMPARISON

COMPETITOR VS WISDOM

SET EQUIPMENT SHIPMENT
CAN NOT MEET CUSTOMIZED DESIGN

VS

MODULAR DESIGN
MODULAR DESIGN, UNIQUE SHAPE FOR EASY IDENTIFICATION
CLEAR STRUCTURE FOR EASY ASSEMBLY, EFFICIENT AND CONVENIENT CONSTRUCTION.

COMPETITOR VS WISDOM

15-30 DAYS
SLOWER SHIPPING
SET EQUIPMENT IN STOCK WILL HAVE TROUBLE TO SHIP IF THERE ARE MISSING PARTS

VS

3-5 DAYS
SHIPS IN 3-5 DAYS
WISDOM IS DIFFERENT FROM THE OVERALL MARKET IN THE AVAILABILITY WE OFFER. WE STOCK A WIDE VARIETY OF EQUIPMENT IN OUR QUICK SHIP SECTION. FROM THE TIME THE ORDER IS PLACED DELIVERY OF PRODUCT WILL ARRIVE IN 3-5 DAYS

COMPETITOR VS WISDOM

37" SMALL DECK
DECK SIZE 37 X 37 IN, COVERING 9.4 SQ FT. CAPACITY FOR ONLY 9 KIDS PER DECK, MAX LOADING WEIGHT 2500LBS ONLY

VS

41" BIG DECK
DECK SIZE 41 X 41 IN, COVERING 11.6 SQ FT. **23%** MORE THAN 37 X 37 IN DECK. INCREASE CAPACITY TO 11 KIDS PER DECK, MAX LOADING WEIGHT 3000LBS

3.5 INCH SYSTEM FULLY INCLUSIVE



COMPETITOR VS WISDOM

PARTIALLY MEETS
37 IN TRIANGLE DECK
PARTIALLY MEET ADA REQUIREMENT

VS

FULLY MEETS
41 IN TRIANGLE DECK
FULLY MEET ADA REQUIREMENT

COMPETITOR VS WISDOM

LOW QUALITY MATERIAL
LOW COST MATERIAL, SIMPLE PRODUCTION PROCESS
OBVIOUS GAPS, LESS ABILITY TO RESIST OUTDOOR ENVIRONMENT

VS

FINE MATERIAL AND PRODUCTION
SLIDES WITH ROTATIONAL MOLDING PROCESS, GRANULATION TECHNOLOGY AND MODIFIED MATERIALS
HEAT AND COLD RESISTANCE, ANTI-AGING AND ANTISTATIC

COMPETITOR VS WISDOM

37" DECK
DECK SIZE 37 X 37 IN
CAN NOT USE DOUBLE SLIDE

VS

41" DECK
DECK SIZE 41 X 41 IN
FULLY MEET THE WIDTH REQUIREMENT FOR DOUBLE SLIDE

COMPETITOR VS WISDOM

31" PANEL
REGULAR SIZE PANEL
THIN AND LIGHT, LESS SPACIOUS DESIGN

VS

34" PANEL
PANEL IS 3" WIDER RESULTING IN A **10%** LARGER APPEARANCE

In line with international safety standards



AGE RESTRICTION GUIDELINES

While ASTM does not explicitly define strict age limitations for different surfacing options, Wisdom Playgrounds follows general industry guidelines. There are no specific fall height limits for ages 2-12 when factoring in the type of surfacing selected. In order to prioritize the safety of kids of all ages Wisdom Playgrounds suggests a maximum fall height of approximately 60" for ages 2-5, which is noted throughout the catalog. Please refer to ASTM standards for items above 60" fall height and surfacing options.



LEADER IN HEALTH & SAFETY

At Wisdom Playgrounds, safety, quality, and child development are at the core of everything we do. We recognize that children's bodies are still growing and are especially vulnerable to harmful substances, which is why we maintain strict standards for the chemical content of every material used in our playground equipment. Our commitment goes beyond safety—we design our products to create secure, engaging environments where kids can play naturally, stay active, and thrive.

Our structures are built to handle high-traffic spaces like kindergartens and daycares, while prioritizing thoughtful design to minimize collision risks and other potential hazards. By addressing both the physical and emotional well-being of children, we create play areas that support holistic development.

At Wisdom Playgrounds, we believe children are the hope and future of our world. That's why we are dedicated to providing safe, green, and innovative learning environments where they can grow and explore with confidence. For over 30 years, this has been our guiding principle—and we look forward to continuing this mission for many years to come. Together, let's create brighter futures for every child.



SUSTAINABLE & ENVIRONMENTAL PROTECTOR

WISDOM has successively obtained multiple certificates that comply with international standards, such as ISO9001, ISO14001, ISO45001, FSC and China Green Product certification, marking WISDOM's strategic ability and determination to adhere to sustainable development!

Implement the concept of eco and quality, integrate global advanced education concepts into the DNA of WISDOM products with the eyes of the world, and aspire to provide green, eco, and high-quality products for children around the world. Help children explore the world with peace of mind and experience a beautiful and happy childhood!



IPEMA CERTIFICATION PROGRAM

In the interest of playground safety, the International Play Equipment Manufacturers Association (IPEMA) provides a Third Party Certification program whereby a designated independent laboratory, TÜV SÜD America Inc., (TÜV), validates an equipment manufacturer's certification of compliance to the ASTM F1487 Standard Consumer Safety Performance Specification for Playground Equipment for Public Use, except sections 7.1.1, 10, 13.1.1, 13.1.2, 13.2, and 13.3; to CAN/CSA Z614 Children's Playground Equipment and Surfacing, except clauses 10 and 11; or both. A list of current validated products may be viewed at www.ipema.org.



PHYSICAL SAFETY



CHEMICAL SAFETY



STRUCTURAL SAFETY

THE MAKING OF A WISDOM PLAYGROUND SYSTEM

Quality you can see, value you can measure



LIFE-TIME WARRANTY

- 1: Excellent quality: All equipment materials are specially selected, sturdy, safe, eco, and durable.
- 2: Long-term warranty: Up to 15-100 years warranty on main structure against structural failure due to material or manufacturing defects.

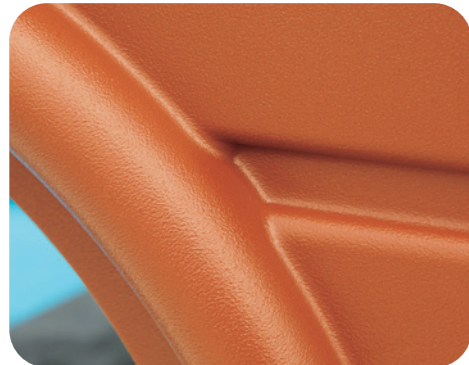

ROTOMOLDED PROCESS

- 1: Quality materials: Selected high-grade LLDPE raw materials, linear low density polyethylene, impact resistance, cracking resistance, heat/cold resistance, acid, alkali and organic solvent resistance, etc., perfectly adapted to various harsh outdoor environments.
- 2: Flexible design: not limited by size/pattern/color/thickness, designers can freely play and easily meet ideal expectations.
- 3: Eco & Safety: one-time molding, no scraps, no waste, non-toxic and odorless.



CLAMP ASSEMBLY

- 1: Clamp design: abandon the common phenomenon of only screw fixing, which is prone to loosening and shaking over time. The clamp design is stable and firm.
- 2: High quality metal: strong stability, burst resistance, cracking resistance, rusty resistance and fine polished, no corners or sharp edges, ensure safety in daily use.
- 3: Convenient assembly: "One loop, one clamp" closed-loop fastening. Simple assembly, convenient maintenance.



PROFESSIONAL WELDING

- 1: Mature craftsmanship: Senior craftsman meticulously works, with even welding joints and careful polishing, with no burrs, incomplete penetration, or porosity overall.
- 2: Safety first: The welding joints are stable, firm, and smooth, strictly ensuring product safety.



TUBULAR POST

- 1: Thickening material: fabricated of 3.5 in. outside diameter, 13 gauge galvanized steel tubing, making it more secure and safe.
- 2: Two mount types: Inground mount and surface mount as needed.

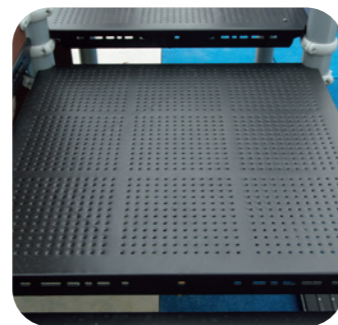

DECK/STAIRS

- 1: Selected Metal: High strength cold rolled steel flat, structurally and mechanically stable, corrosion-resistant, weather resistant, safe and eco, suitable for outdoor use.
- 2: PVC coating: After professional technical treatment such as gluing, preheating, PVC coating, and high-temperature curing, the steel deck has improved its anti slip, anti wear, anti static, and anti crack properties, making it new over time.



QUALITY POWDER COATING

- 1: High-end technology: To avoid problems such as rust and aging of steel tubes, we use high-end hot dip galvanizing technology combined with high-quality outdoor powder coating to extend the service life!
- 2: Craftsmanship process: Galvanized tubes require a total of 13 processes, including water washing, oil removal/impurity removal, and electrostatic spraying. Ensure smooth and flat surface, rust and corrosion resistance, and long-term durability.



Quick Ship

At Wisdom Playgrounds, we take pride in setting ourselves apart with our industry-leading Quick Ship options, designed to get your playground up and running faster than ever. While many suppliers take weeks or even months to deliver, we offer high-quality playground equipment that ships in just 3-5 days after your order is placed. This means you can meet tight deadlines without the frustration of long wait times.

What truly makes our Quick Ship program exceptional is that we don't sacrifice quality for speed. Unlike competitors, we uphold the highest standards of craftsmanship, using durable materials and precision engineering to ensure every structure is built for long-term performance, safety, and fun. Whether you're outfitting a new park, upgrading an existing play area, or meeting an urgent project deadline, our Quick Ship selection provides the perfect blend of efficiency and reliability.

And don't forget—you're not limited to just Quick Ship structures! You can mix and match with complementary elements like WiseQUBES, swings, and climbers to create a fully customized, engaging play environment tailored to your space and community needs. With Wisdom Playgrounds, getting a high-quality, personalized playground has never been easier or faster!

- 009 WisePLAY Quick Ship
- 029 WisePLAY Inclusive Quick Ship
- 033 WiseTOT Quick Ship
- 045 WiseNEX Quick Ship
- 049 WiseFREE Quick Ship
- 057 WiseSITE Quick Ship



www.wisdomplaygrounds.com

WisePLAY Quick Ship

WisePLAY Quick Ship playgrounds are the perfect solution for quickly enhancing your facility with high-quality, activity-packed play spaces. True to their name, these playgrounds can arrive on-site within just 3-5 days, making them ideal when time is of the essence.

Designed for small to medium spaces, WisePLAY Quick Ship structures keep purchasing and shipping costs lower than the competition. Built with 3.5" posts instead of 5" posts, they're lighter, more versatile, and easy to install while maintaining durability and safety.

Each playground offers a choice of primary or natural color palettes, giving you flexibility without sacrificing quality. With WisePLAY Quick Ship, you get a reliable, engaging playground delivered fast and efficiently—ready for endless fun!

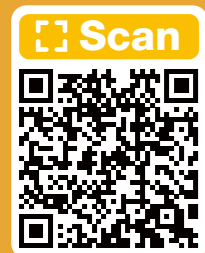

Scan above to learn more



Quick Ship



WisePLAY



3.5" Post



ADA



NAPLES I QSWP-350106

Ages: 5-12

Fall Height: 60"

Use Zone: 43'x41'

Equipment Size: 30'5" x 27'4"

Timbers: 36

NATURE



PRIMARY

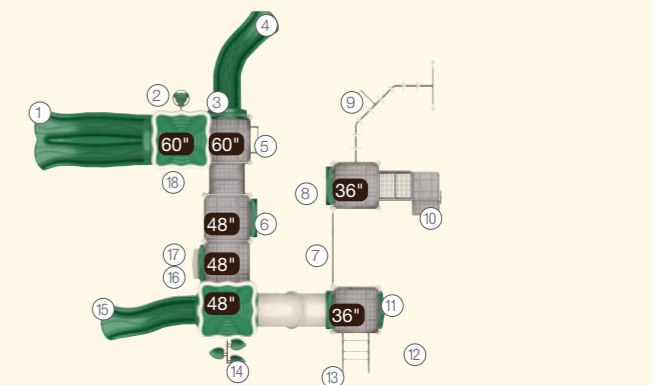

- ① 5ft Double Slide
- ② 5ft Pod Climber
- ③ Tic-Tac-Toe Panel
- ④ 5ft Sectional Slide 45° Right Turn
- ⑤ 5ft Straight Rung Climber
- ⑥ World Map Panel
- ⑦ Net Climber - Ladder
- ⑧ Gears Panel
- ⑨ 90° Overhead Swinging Rings
- ⑩ ADA Transfer Station
- ⑪ Safety Panel
- ⑫ Palm Topper
- ⑬ 3ft Arch Climber
- ⑭ 4ft Leaf Step Climber
- ⑮ 4ft Single Slide
- ⑯ Counter Panel (Below)
- ⑰ 4ft Leaf Step Climber
- ⑱ 5ft PE Vertical Climber w/Fixing Holes



GALENA | QSWP-350065

Ages: 5-12
Fall Height: 84"
Use Zone: 51'x38'
Equipment Size: 39'x25'8"
Timbers: 38

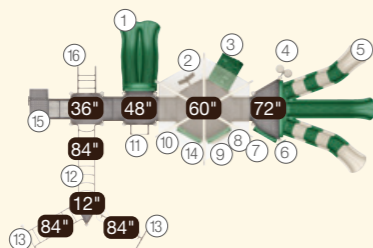

- ① 4ft Double Slide
- ② 5ft Wing Climber
- ③ 4ft/5ft Rock Climber
- ④ Bongo
- ⑤ 6ft Triple Sectional Split Slide
- ⑥ Rain Wheel
- ⑦ Window Panel
- ⑧ Four In A Row Panel
- ⑨ Counter Panel(Below)
- ⑩ Gears Panel
- ⑪ 4ft Straight Rung Climber
- ⑫ Net Climber-Ladder
- ⑬ Overhead Rotating Rings
- ⑭ Saddle Seat
- ⑮ ADA 3ft Transfer Station
- ⑯ 4ft Arch Climber



BONGO PLAY | QSWP-350011

Ages: 5-12
Fall Height: 72"
Use Zone: 39'x26'
Equipment Size: 26'9"x13'11"
Timbers: 27

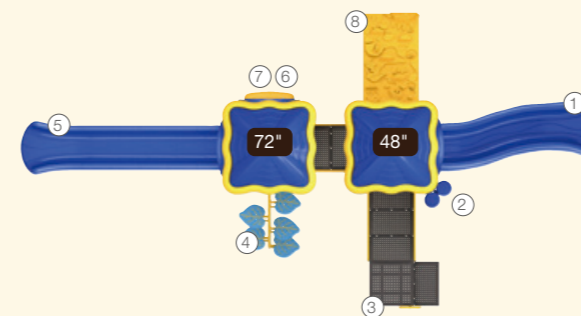

- ① 4ft Single Slide
- ② Bongo
- ③ 4ft ADA Stairs
- ④ 6ft Leaf Step Climber
- ⑤ 6ft Sectional Slides
- ⑥ Counter Panel (Below)
- ⑦ Gears Panel
- ⑧ 4ft/5ft Rock Climber



HARPERS PLACE | QSWP-350019

Ages: 5-12
Fall Height: 72"
Use Zone: 47'x29'
Equipment Size: 34'10"x16'6"
Timbers: 32

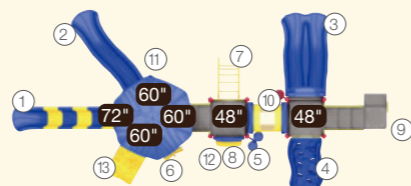

- ① 6ft Sectional Slides
- ② 5ft Single Slide
- ③ 4ft Double Slide
- ④ Double-sided Wave Rock Climber
- ⑤ Bongo
- ⑥ 5ft Wing Climber
- ⑦ 4ft Arch Climber
- ⑧ Counter Panel(Below)
- ⑨ ADA Transfer Station
- ⑩ Crawl Tunnel
- ⑪ Rain Wheel
- ⑫ Maze Panel(Above)
- ⑬ Rock Climber



SKYLER | QSWP-350066

Ages: 5-12
Fall Height: 84"
Use Zone: 40' x 42'
Equipment Size: 27'11"x29'8"
Timbers: 34

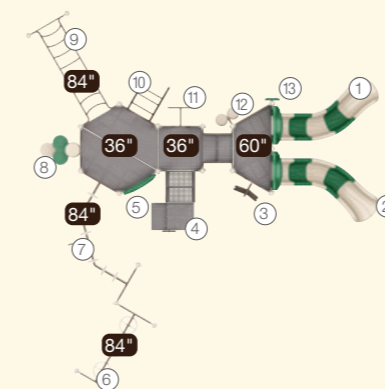

- ① 5ft Sectional Slide 45°Left Turn
- ② 5ft Sectional Slide 45°Right Turn
- ③ 5ft Wing Climber
- ④ ADA 3ft Transfer Station
- ⑤ Maze Panel
- ⑥ Overhead Rotating Rings
- ⑦ 90° Overhead Swinging Rings
- ⑧ 3ft Trunk Climber
- ⑨ Net Climber-Ladder
- ⑩ 3ft Arch Climber
- ⑪ 3ft Snake Climber
- ⑫ Bongo
- ⑬ Rain Wheel





W/O

00

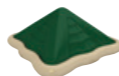

11



12



13

WILD RUN | QSWP-350064

Ages: 5-12
Fall Height: 84"
Use Zone: 51' x 32'
Equipment Size: 39'x19'1"
Timbers: 37

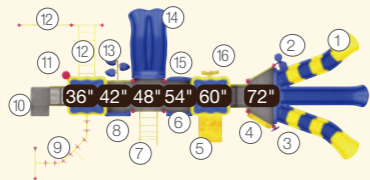

- ① 6ft Triple Sectional Split Slide
- ② Bongo
- ③ Rain Wheel
- ④ Saddle Seat
- ⑤ 4ft/5ft Rock Climber
- ⑥ Gears Panel
- ⑦ 4ft Arch Climber
- ⑧ Window Panel
- ⑨ 90° Overhead Swinging Rings
- ⑩ ADA 3ft Transfer Station
- ⑪ PE Stool
- ⑫ Net Climber-Ladder
- ⑬ 4ft Leaf Step Climber
- ⑭ 4ft Double Slide
- ⑮ Beads & Cups Panel
- ⑯ 5ft Wing Climber

3.5



POETER | QSWP-350062

Ages: 5-12
Fall Height: 72"
Use Zone: 36'x29'
Equipment Size: 23'10"x16'9"
Timbers: 28

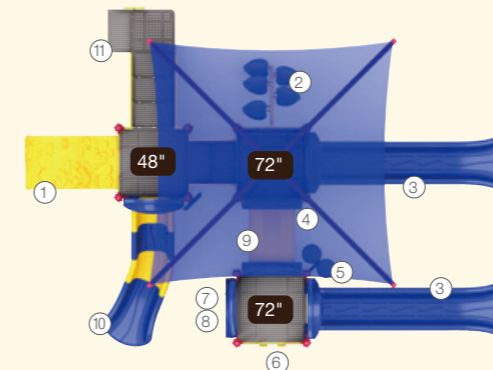

- ① 4ft/5ft Rock Climber
- ② 6ft Leaf Step Climber
- ③ 6ft Straight Slide
- ④ Saddle Seat (Below)
- ⑤ Bongo
- ⑥ 6ft Upright PE Rock Climber
- ⑦ Beads & Cups Panel (Above)
- ⑧ Gears Panel (Below)
- ⑨ Rain Wheel
- ⑩ ADA 4ft Transfer Station

W/O

00



11



12



13



W/O

00



12



33

CHARLOTTE | QSWP-350102

Ages: 5-12
Fall Height: 72"
Use Zone: 51'x39'
Equipment Size: 38'1"x26'6"
Timbers: 41

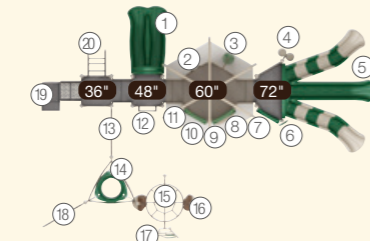

- ① 4ft Double Slide
- ② 5ft PE Vertical Climber w/Fixing Holes
- ③ 5ft Pod Climber
- ④ Bongo
- ⑤ 6ft Triple Sectional Split Slide
- ⑥ Rain Wheel
- ⑦ Window Panel
- ⑧ Four In A Row Panel (Above)
- ⑨ Counter Panel (Below)
- ⑩ Gears Panel (Above)
- ⑪ Saddle Seat (Below)
- ⑫ 4ft Straight Rung Climber
- ⑬ Net Climber - Ladder
- ⑭ O-zone Climber
- ⑮ Overhead Challenger
- ⑯ Bear Step
- ⑰ 6ft PE Climber w/Deck
- ⑱ Sail PE Climbing Panel
- ⑲ ADA 3ft Transfer Station
- ⑳ 3ft Arch Climber

FALCON RIDGE | QSWP-350014

Ages: 5-12
Fall Height: 72"
Use Zone: 48'x29'
Equipment Size: 35'3"x16'8"
Timbers: 32

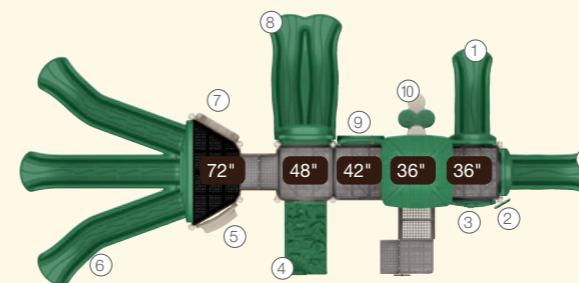

- ① 3ft Single Slide
- ② Rain Wheel
- ③ Safety Panel
- ④ 4ft/5ft Rock Climber
- ⑤ Counter Panel
- ⑥ 6ft Triple Sectional Split Slide
- ⑦ Saddle Seat
- ⑧ 4ft Double Slide
- ⑨ Gears Panel
- ⑩ 3ft Trunk Climber

3.5



W/O

00



11



12



13



3.5



WILMINGTON | QSWP-350100

Ages: 5-12
 Fall Height: 84"
 Use Zone: 38'x39'
 Equipment Size: 24'1"x26'3"
 Timbers: 33

NATURE PRIMARY

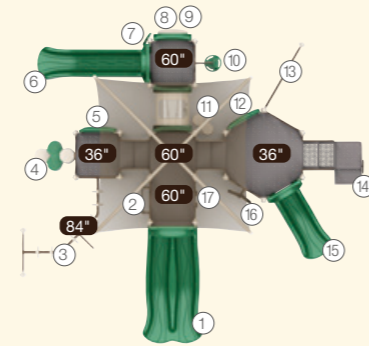

- | | |
|--|-----------------------------|
| ① 5ft Double Slide | ② 5ft Straight Rung Climber |
| ③ 90° Overhead Swinging Rings | ④ 3ft Trunk Climber |
| ⑤ Maze Panel | ⑥ 5ft Sectional Slide |
| ⑦ Rain Wheel | ⑧ Gears Panel (Above) |
| ⑨ Counter Panel (Below) | ⑩ 5ft Pod Climber |
| ⑪ Bongo | ⑫ Beads & Cups Panel |
| ⑬ Net Climber - Ladder | ⑭ ADA 3ft Transfer Station |
| ⑮ 3ft Single Slide | ⑯ 3ft Wing Climber |
| ⑰ 5ft PE Vertical Climber w/Fixing Holes | |



3.5



MCKINLEY | QSWP-350067

Ages: 5-12
 Fall Height: 84"
 Use Zone: 45'x34'
 Equipment Size: 32'8"x20'6"
 Timbers: 31

NATURE PRIMARY

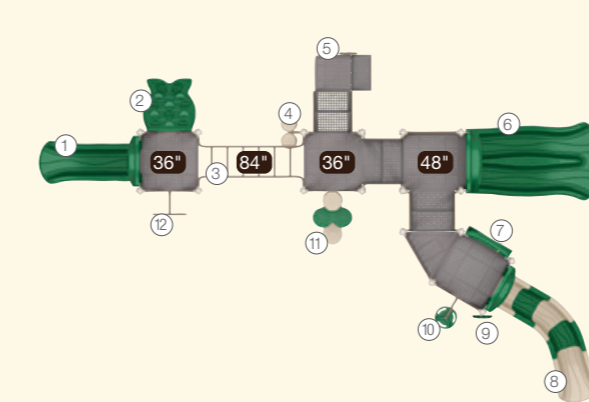

- | | |
|----------------------------|--------------------------------------|
| ① 3ft Single Slide | ② 3ft Fish Climber |
| ③ Challenge Ladder | ④ Bongo |
| ⑤ ADA 3ft Transfer Station | ⑥ 4ft Double Slide |
| ⑦ Gears Panel | ⑧ 5ft Sectional Slide 45° Right Turn |
| ⑨ Rain Wheel | ⑩ 5ft Pod Climber |
| ⑪ 3ft Trunk Climber | ⑫ 3ft Wing Climber |



3.5



MARYLAND | QSWP-350107

Ages: 5-12
 Fall Height: 72"
 Use Zone: 44'x42'
 Equipment Size: 29'11"x29'15"
 Timbers: 37

NATURE PRIMARY

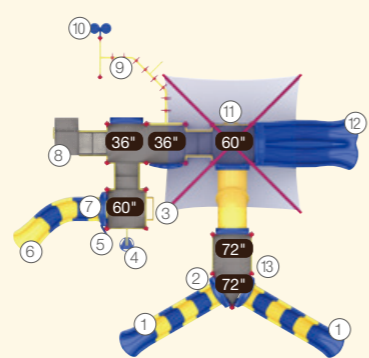

- | | |
|--|-------------------------------------|
| ① 6ft Sectional Slide | ② ABC Panel |
| ③ 5ft Straight Rung Climber | ④ 5ft Pod Climber |
| ⑤ Rain Wheel | ⑥ 5ft Sectional Slide 45° Left Turn |
| ⑦ Saddle Seat (Below) | ⑧ ADA 3ft Transfer Station |
| ⑨ 90° Overhead Swinging Rings | ⑩ Bongo |
| ⑪ 5ft PE Vertical Climber w/Fixing Holes | ⑫ 5ft Double Slide |
| ⑬ Counter Panel | |



MIGHTY MAGIC | QSWP-350027

Ages: 5-12
 Fall Height: 84"
 Use Zone: 33'x32'
 Equipment Size: 20'10"x19'3"
 Timbers: 29

NATURE PRIMARY

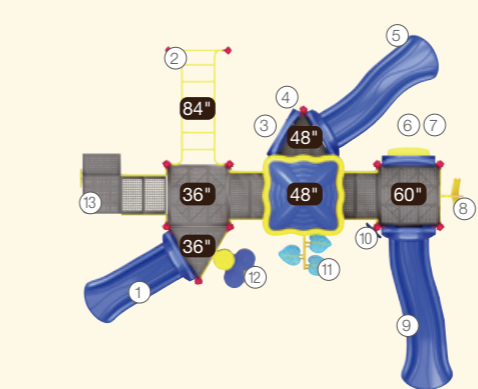

- | | |
|----------------------------|-----------------------|
| ① 3ft Single Slide | ② Challenge Ladder |
| ③ Gears Panel | ④ Saddle Seat (Below) |
| ⑤ 4ft Single Slide | ⑥ Window Panel |
| ⑦ Counter Panel (Below) | ⑧ 5ft Wing Climber |
| ⑨ 5ft Single Slide | ⑩ Rain Wheel |
| ⑪ 4ft Leaf Step Climber | ⑫ 3ft Trunk Climber |
| ⑬ ADA 3ft Transfer Station | |

3.5





LEAFY TIME | QSWP-350003

Ages: 5-12
 Fall Height: 84"
 Use Zone: 31'x31'
 Equipment Size: 18'6" x 19"
 Timbers: 28

NATURE PRIMARY
 ● ● ● ● ● ●

- ① 4ft Single Slide
- ② 4ft Double Slide
- ③ 4ft/5ft Rock Climber
- ④ 3ft Trunk Climber
- ⑤ Challenge Ladder
- ⑥ Overhead Entry Ladder
- ⑦ Pyramid Roof
- ⑧ ADA 3ft Transfer Station
- ⑨ 3ft Rise Inter Stairs
- ⑩ Bongo

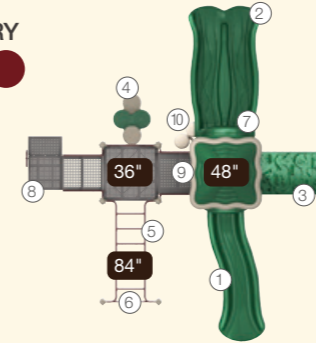

POTOMAC | QSWP-350105

Ages: 5-12
 Fall Height: 60"
 Use Zone: 51'x30'
 Equipment Size: 36'10" x 17'4"
 Timbers: 37

NATURE PRIMARY
 ● ● ● ● ● ●

- ① 5ft Double Slide
- ② 5ft Wing Climber
- ③ Jungle Adventure Panel (Above)
- ④ Counter Panel (Below)
- ⑤ 3ft Single Slide
- ⑥ Zig Zag Overhead Rings
- ⑦ ADA 3ft Transfer Station
- ⑧ 4ft Straight Rung Climber
- ⑨ Bongo
- ⑩ 5ft Pod Climber
- ⑪ 5ft Sectiona Slide 45° Left Turn

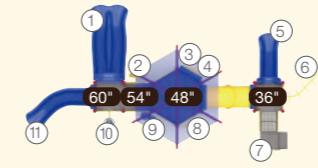

JUNGLE PLAY | QSWP-350026

Ages: 5-12
 Fall Height: 84"
 Use Zone: 31'x29'
 Equipment Size: 19'x16'11"
 Timbers: 25

NATURE PRIMARY
 ● ● ● ● ● ●

- ① Overhead Entry Ladder
- ② 3ft Single Slide
- ③ Rain Wheel
- ④ 5ft Single Slide
- ⑤ Bongo
- ⑥ 4ft/5ft Rock Climber
- ⑦ 5ft Wing Climber
- ⑧ Challenge Ladder
- ⑨ ADA 3ft Transfer Station

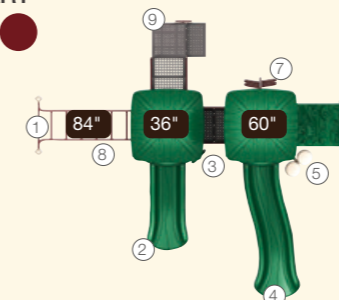

SACRAMENTO | QSWP-350101

Ages: 5-12
 Fall Height: 72"
 Use Zone: 57'x42'
 Equipment Size: 43'4" x 27'4"
 Timbers: 46

NATURE PRIMARY
 ● ● ● ● ● ●

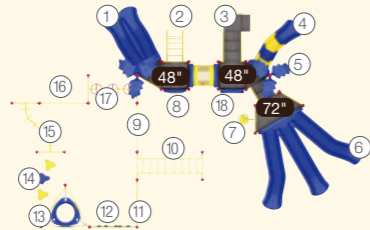

- ① 4ft Double Slide
- ② 4ft Arch Climber
- ③ ADA 4ft Transfer Station
- ④ 4ft Sectional Slide Right Turn
- ⑤ Palm Topper
- ⑥ 6ft Triple Sectional Split Slide
- ⑦ 6ft Pod Climber
- ⑧ Beads & Cups Panel
- ⑨ Rung Challenge Climber
- ⑩ Invert Arch Ladder
- ⑪ Net Climber - Ladder
- ⑫ Net Climber - Grass & Ladybug
- ⑬ O-zone Climber
- ⑭ 12" Clover Step
- ⑮ Zig Zag Overhead Rings
- ⑯ Vertical Net Link
- ⑰ Overhead Rotating Rings
- ⑱ Gears Panel



NORTH PORT | QSWP-350103

Ages: 5-12
 Fall Height: 72"
 Use Zone: 50'x30'
 Equipment Size: 36'1" x 15'9"
 Timbers: 38

NATURE PRIMARY
 ● ● ● ● ● ●

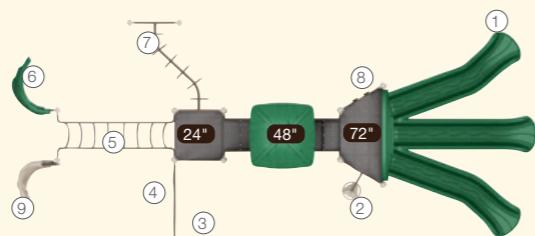

- ① 6ft Triple Sectional Split Slide
- ② 6ft Pod Climber
- ③ Single Bar
- ④ Net Climber - Ladder
- ⑤ Invert Arch Ladder
- ⑥ Moab Rock Climber - L
- ⑦ Zig Zag Overhead Rings
- ⑧ 6ft Vertical Climber
- ⑨ Moab Rock Climber - S



3.5



SPEED RACER | QSWP-350025

Ages: 2-5 & 5-12
 Fall Height: 48"
 Use Zone: 34'x27'
 Equipment Size: 21'10"x15'
 Timbers: 28

NATURE PRIMARY

- ① Saddle Seat
- ② 4ft Double Slide
- ③ Bongo
- ④ 4ft Single Slide
- ⑤ 3ft Trunk Climber
- ⑥ 3ft Snake Climber
- ⑦ 4ft Arch Climber
- ⑧ ADA Transfer Station

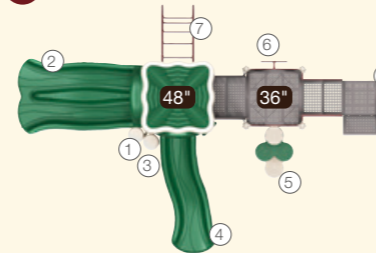

3.5



AUGUSTA | QSWP-350009

Ages: 2-5 & 5-12
 Fall Height: 48"
 Use Zone: 39'x29'
 Equipment Size: 26'2"x17'
 Timbers: 27

NATURE PRIMARY

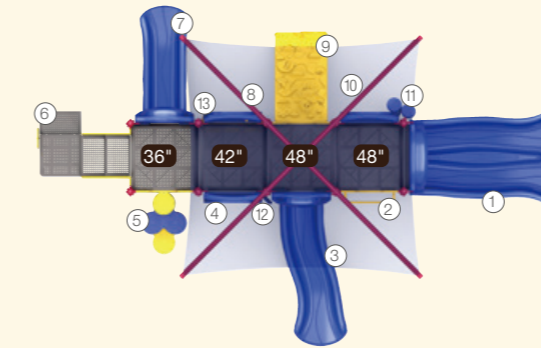

- ① 4ft Double Slide
- ② 4ft Straight Rung Climber
- ③ 4ft Single Slide
- ④ Four In A Row Panel
- ⑤ 2ft/3ft Fish Climber
- ⑥ 3ft ADA Stairs
- ⑦ 3ft Single Slide
- ⑧ Gears Panel
- ⑨ 4ft/5ft Rock Climber
- ⑩ World Map Panel
- ⑪ Bongo
- ⑫ Rain Wheel
- ⑬ Saddle Seat



3.5



SHININ BRIGHT | QSWP-350002

Ages: 2-5 & 5-12
 Fall Height: 48"
 Use Zone: 35'x28'
 Equipment Size: 22'10"x15'3"
 Timbers: 28

NATURE PRIMARY

- ① 4ft Single Slide
- ② ADA 4ft Transfer Station
- ③ 31" Crawl Tunnel
- ④ 4ft Double Slide
- ⑤ 4ft Arch Climber
- ⑥ 4ft/5ft Rock Climber
- ⑦ Pyramid Roof
- ⑧ Saddle Seat (Below)
- ⑨ Safety Panel
- ⑩ Bongo

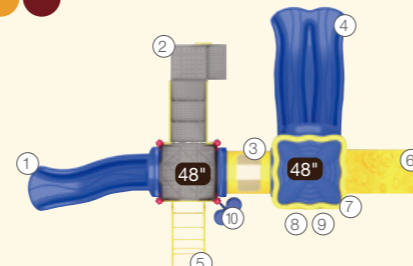

MOUNT RAINIER | QSWP-350018

Ages: 2-5 & 5-12
 Fall Height: 60"
 Use Zone: 35'x32'
 Equipment Size: 22'7"x19'10"
 Timbers: 27

NATURE PRIMARY

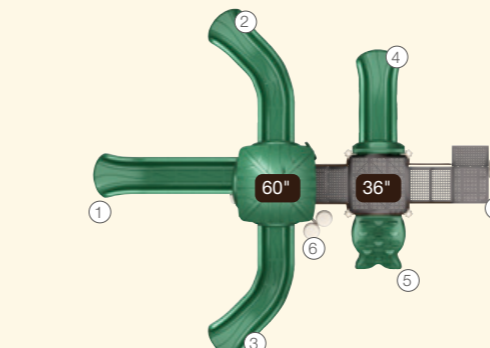

- ① 5ft Single Slide
- ② 5ft Single Slide Left Turn
- ③ 5ft Single Slide Right Turn
- ④ 3ft Single Slide
- ⑤ 2ft/3ft Fish Climber
- ⑥ Bongo
- ⑦ 4ft ADA Stairs



3.5



NORTHERN PLACE | QSWP-350016

Ages: 2-5 & 5-12
 Fall Height: 48"
 Use Zone: 26'x35'
 Equipment Size: 13'11"x22'3"
 Timbers: 23

NATURE PRIMARY

- ① 4ft Single Slide
- ② 4ft/5ft Rock Climber
- ③ 4ft Arch climber
- ④ Bongo
- ⑤ PE Stool
- ⑥ 4ft ADA Stairs

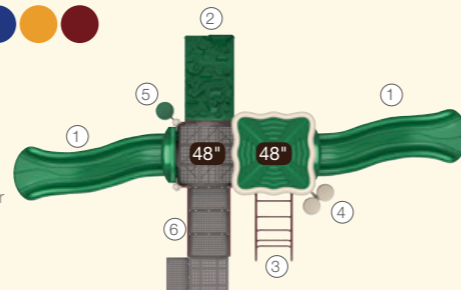

3.5



JANIE | QSWP-350045

Ages: 2-5 & 5-12
 Fall Height: 60"
 Use Zone: 33' x 34'
 Equipment Size: 20'9" x 21'6"
 Timbers: 27

NATURE PRIMARY

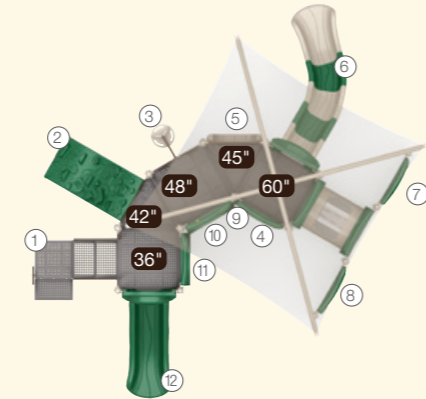

- ① ADA 3ft Transfer Station
- ② 4ft/5ft Rock Climber
- ③ 4ft Pod Climber
- ④ Maze Panel
- ⑤ Saddle Seat
- ⑥ 5ft Sectional Slide 45° Left Turn
- ⑦ Puzzle Panel
- ⑧ Beads & Cups Panel
- ⑨ Rain Wheel
- ⑩ Gears Panel
- ⑪ World Map Panel
- ⑫ 3ft Single Slide

3.5



AHOY MATE | QSWP-350021

Ages: 2-5 & 5-12
 Fall Height: 48"
 Use Zone: 34' x 29'
 Equipment Size: 22' x 16'11"
 Timbers: 25

NATURE PRIMARY

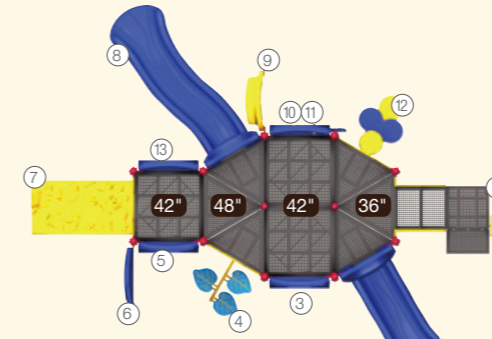

- ① ADA Transfer Station
- ② 3ft Single Slide
- ③ World Map Panel
- ④ 4ft Leaf Climber
- ⑤ Four In A Row Panel
- ⑥ Puzzle Panel
- ⑦ 4ft/5ft Rock Climber
- ⑧ 4ft Single Slide
- ⑨ Counter Panel
- ⑩ Gears Panel
- ⑪ Rain Wheel
- ⑫ 3ft Trunk Climber
- ⑬ Window Panel

3.5



W/O

00



32



33

ROCKY | QSWP-350046

Ages: 2-5 & 5-12
 Fall Height: 60"
 Use Zone: 34' x 31'
 Equipment Size: 21'3" x 18'10"
 Timbers: 26

NATURE PRIMARY

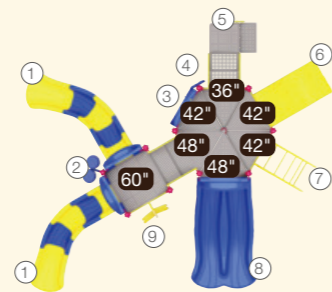

- ① 5ft Sectional Slide 45° Left Turn
- ② Bongo
- ③ Gears Panel
- ④ Rain Wheel
- ⑤ ADA 3ft Transfer Station
- ⑥ 4ft/5ft Rock Climber
- ⑦ 4ft Arch Climber
- ⑧ 4ft Double Slide
- ⑨ 5ft Wing Climber

BUGALOO | QSWP-350008

Ages: 2-5 & 5-12
 Fall Height: 48"
 Use Zone: 30' x 30'
 Equipment Size: 17'10" x 17'1"
 Timbers: 31

NATURE PRIMARY

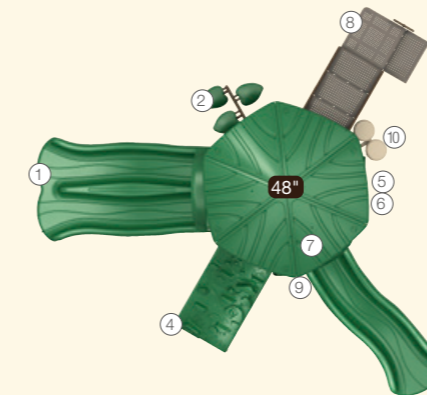

- ① 4ft Double Slide
- ② 4ft Leaf Step Climber
- ③ 4ft Single Slide
- ④ 4ft/5ft Rock Climber
- ⑤ Gears Insert
- ⑥ Saddle Seat (Below)
- ⑦ Hex Leaf Roof
- ⑧ ADA 4ft Transfer Station
- ⑨ Rain Wheel
- ⑩ Bongo

3.5





3.5



TIMBER TRACKS | QSWP-350006

Ages: 2-5 & 5-12
 Fall Height: 60"
 Use Zone: 30'x34'
 Equipment Size: 17'5" x 21'8"
 Timbers: 27

NATURE PRIMARY

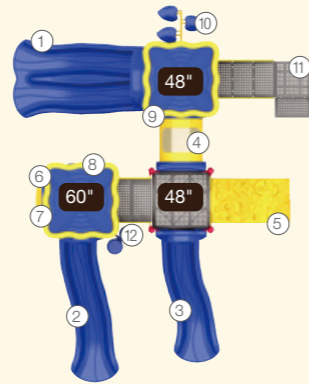

- ① 4ft Double Slide
- ② 5ft Single Slide
- ③ 4ft Single Slide
- ④ Crawl Tunnel
- ⑤ 4ft/5ft Rock Climber
- ⑥ Gears Panel
- ⑦ Counter Panel (Below)
- ⑧ Safety Panel
- ⑨ Saddle Seat (Below)
- ⑩ 4ft Leaf Step Climber
- ⑪ ADA 4ft Transfer Station
- ⑫ Bongo



3.5



DENVER | QSWP-350022

Ages: 2-5 & 5-12
 Fall Height: 60"
 Use Zone: 40'x28'
 Equipment Size: 27'4" x 16"
 Timbers: 27

NATURE PRIMARY

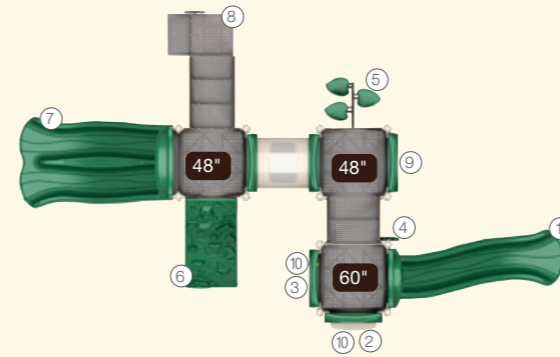

- ① 5ft Single Slide
- ② Four In A Row Panel
- ③ Gears Panel
- ④ Rain Wheel
- ⑤ 4ft Leaf Step Climber
- ⑥ 4ft/5ft Rock Climber
- ⑦ 4ft Double Slide
- ⑧ 3ft Trunk Climber
- ⑨ Saddle Seat
- ⑩ Counter Panel



3.5



W/O

00

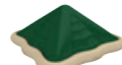

11



12



13

OLYMPIA | QSWP-350023

Ages: 2-5 & 5-12
 Fall Height: 60"
 Use Zone: 50'x32'
 Equipment Size: 37'9" x 19'6"
 Timbers: 34

NATURE PRIMARY

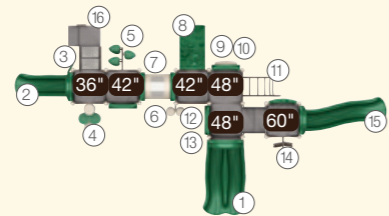

- ① 4ft Double Slide
- ② 3ft Single Slide
- ③ Rain Wheel
- ④ 3ft Trunk Climber
- ⑤ 4ft Leaf Step Climber
- ⑥ Bongo
- ⑦ Crawl Tunnel
- ⑧ 4ft/5ft Rock Climber
- ⑨ ABC Panel
- ⑩ Counter Panel (Below)
- ⑪ 4ft Arch Climber
- ⑫ World Map Panel
- ⑬ Saddle Seat (Below)
- ⑭ 5ft Wing Climber
- ⑮ 5ft Single Slide
- ⑯ ADA 3ft Transfer Station

3.5



W/O

00



11



12



13

SHADY PINES | QSWP-350005

Ages: 2-5 & 5-12
 Fall Height: 60"
 Use Zone: 41'x30'
 Equipment Size: 28'6" x 17'3"
 Timbers: 29

NATURE PRIMARY

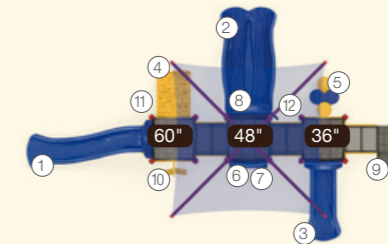

- ① 5ft Single Slide
- ② 4ft Double Slide
- ③ 3ft Single Slide
- ④ 4ft/5ft Rock Climber
- ⑤ 3ft Trunk Climber
- ⑥ World Map Panel
- ⑦ Saddle Seat (Below)
- ⑧ 14ft x 14ft Square Shade
- ⑨ ADA 3ft Transfer Station
- ⑩ 5ft Wing Climber
- ⑪ Counter Panel
- ⑫ Rain Wheel



W/O 00

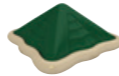

11



12



13

PLAY TIME | QSWP-350010

Ages: 2-5
Fall Height: 48"
Use Zone: 41'x28'
Equipment Size: 28'11"x15'2"
Timbers: 28

NATURE PRIMARY
● ● ● ● ● ●

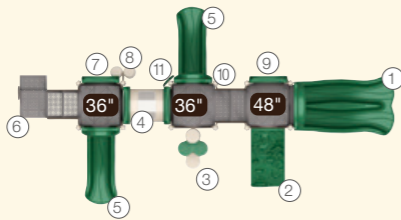

- ① 4ft Double Slide
- ② 4ft/5ft Rock Climber
- ③ 3ft Trunk Climber
- ④ Crawl Tunnel
- ⑤ 3ft Single Slide
- ⑥ ADA 3ft Transfer Station
- ⑦ Large Window Panel
- ⑧ Bongo
- ⑨ World Map Panel
- ⑩ Saddle Seat
- ⑪ Rain Wheel



TURTLE ISLAND | QSWP-350056

Ages: 2-5
Fall Height: 36"
Use Zone: 30'x28'
Equipment Size: 17'11"x15'11"
Timbers: 25

NATURE PRIMARY
● ● ● ● ● ●

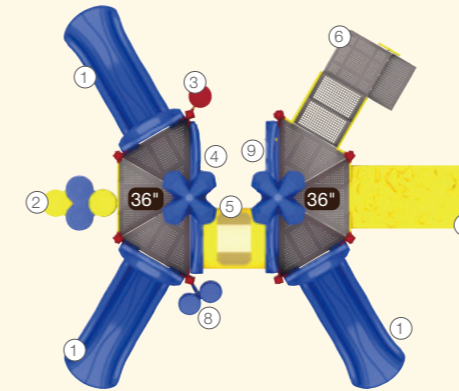

- ① 3ft Single Slide
- ② 3ft Trunk Climber Inground Footer
- ③ PE Stool
- ④ Beads & Cups Panel
- ⑤ Crawl Tunnel
- ⑥ ADA 3ft Transfer Station
- ⑦ 4ft/5ft Rock Climber
- ⑧ Bongo
- ⑨ Gears Panel

W/O 00



07



06



W/O 00

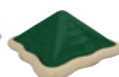

11



12



13

ZAK | QSWP-350060

Ages: 2-5
Fall Height: 60"
Use Zone: 58' x 21'
Equipment Size: 45'4"x12'3"
Timbers: 35

NATURE PRIMARY
● ● ● ● ● ●

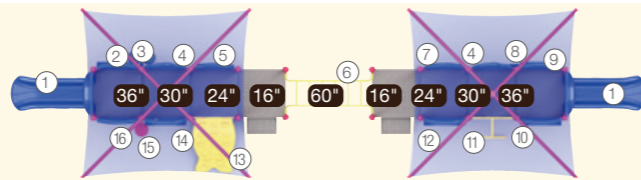

- ① 3ft Single Slide
- ② ABC Panel
- ③ Bongo
- ④ Safety Panel
- ④ Beads & Cups Panel
- ④ Challenge Ladder
- ⑤ Rain Wheel
- ⑤ Four in A Row Panel
- ⑥ Window Panel
- ⑥ Rain Wheel
- ⑥ World Map Panel
- ⑦ 2ft/3ft Fish Climber
- ⑦ PE Stool
- ⑧ Puzzle Panel
- ⑧ Gears Panel
- ⑧ PE Stool

SUNNY STACK | QSWP-350017

Ages: 2-5
Fall Height: 48"
Use Zone: 29'x23'
Equipment Size: 16'2"x10'11"
Timbers: 23

NATURE PRIMARY
● ● ● ● ● ●

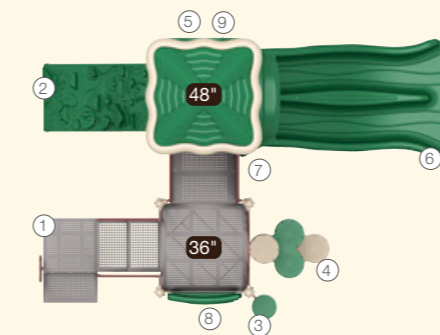

- ① ADA 3ft Transfer Station
- ② 4ft/5ft Rock Climber
- ③ PE Stool
- ④ 3ft Trunk Climber
- ⑤ Gears Panel
- ⑥ 4ft Double Slide
- ⑦ Rain Wheel
- ⑧ Maze Panel
- ⑨ Saddle Seat(Below)



W/O 00

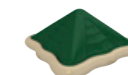

11



12



13

3.5



BOBBIE | QSWP-350042

Ages: 2-5
 Fall Height: 36"
 Use Zone: 32' x 22'
 Equipment Size: 19'3" x 10'11"
 Timbers: 24

NATURE **PRIMARY**

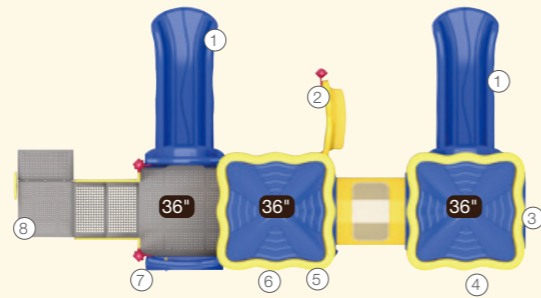

- ① 3ft Single Slide
- ② Counter Panel
- ③ World Map Panel
- ④ Beads & Cups Panel
- ⑤ Rain Wheel
- ⑥ Safety Panel
- ⑦ Gears Panel
- ⑧ ADA 3ft Transfer Station



3.5



MINNIE | QSWP-350041

Ages: 2-5
 Fall Height: 36"
 Use Zone: 26' x 18'
 Equipment Size: 14' x 6"
 Timbers: 20

NATURE **PRIMARY**

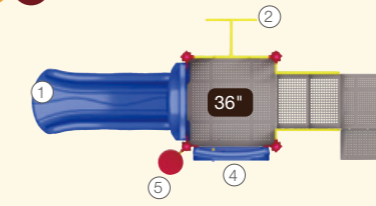

- ① 3ft Single Slide
- ② 3ft Snake Climber
- ③ ADA 3ft Transfer Station
- ④ Gears Panel
- ⑤ PE Stool



JEREMY | QSWP-350043

Ages: 2-5
 Fall Height: 36"
 Use Zone: 27' x 17'
 Equipment Size: 14'1" x 12'3"
 Timbers: 24

NATURE **PRIMARY**

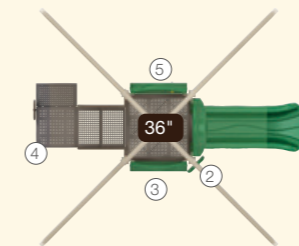

- ① 3ft Single Slide
- ② Rain Wheel
- ③ Gears Panel
- ④ ADA 3ft Transfer Station
- ⑤ Four in A Row Panel

3.5



3.5



SUNNY DAYS | QSWP-350004

Ages: 2-5
 Fall Height: 36"
 Use Zone: 30' x 25'
 Equipment Size: 17'5" x 12'11"
 Timbers: 24

NATURE **PRIMARY**

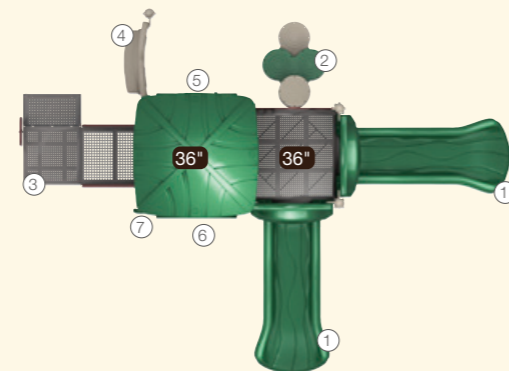

- ① 3ft Single Slide
- ② 3ft Trunk Climber
- ③ ADA 3ft Transfer Station
- ④ Counter Panel
- ⑤ Gears Panel
- ⑥ Four In A Row Panel
- ⑦ Rain Wheel



KIDZ BUS | QS76-21079

Ages: 2-5
 Fall Height: 36"
 Use Zone: 29' x 21'
 Equipment Size: 16'4" x 8'7"
 Timbers: 28

COLOR

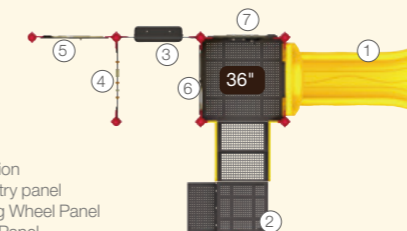

- ① 3ft Single Slide
- ② ADA 3ft Transfer Station
- ③ School Bus - Geometry panel
- ④ School Bus - Steering Wheel Panel
- ⑤ School Bus - Engine Panel
- ⑥ School Bus - Window Panel
- ⑦ School Bus - Gears Panel

3.5



WisePLAY Inclusive Quick Ship

WisePLAY Inclusive Quick Ship playgrounds are designed to create a welcoming space where children and caregivers of all abilities can play, connect, and explore—without barriers or limitations. Thoughtfully crafted with inclusivity in mind, these playgrounds provide opportunities for shared experiences that bring people together in a safe and supportive environment.

Built with durable 3.5" galvanized steel posts, WisePLAY structures offer exceptional strength and versatility while maintaining a lighter design that makes installation easier and more efficient. Engineered for lasting performance, they stand up to years of joyful play, giving you peace of mind when it comes to durability and safety.

Whether you're working on a tight schedule or need a quick solution, WisePLAY Inclusive Quick Ship playgrounds arrive on-site in as little as 3-5 days. Designed to fit a variety of spaces, they ensure that playtime remains accessible, engaging, and barrier-free for children and caregivers alike. With WisePLAY, every child gets the chance to play, discover, and thrive—together.

Scan



Scan above to learn more



Quick Ship



WisePLAY



Inclusive



3.5" Post



ADA



MEMPHIS I QSWP-350037

Ages: 2-12 & 5-12

Fall Height: 60"

Use Zone: 56'x42'

Equipment Size: 43'9"x29'11"

Timbers: 39

NATURE



PRIMARY

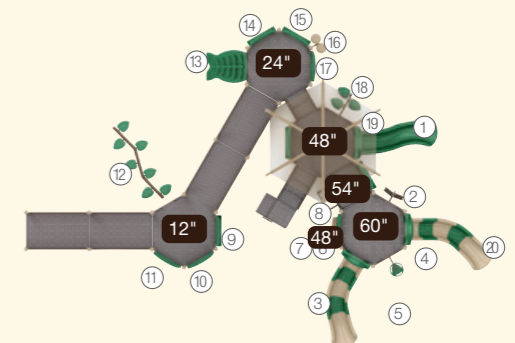

- ① 4ft Sectional Slide Left Turn
- ② 5ft Wing Climber
- ③ 5ft Sectional Slide Left Turn
- ④ ABC Panel(Below)
- ⑤ 5ft Pod Climber
- ⑥ Beads & Cups Panel(Above)
- ⑦ Counter Panel (Below)
- ⑧ 5ft Straight Rung Climber
- ⑨ World Map Panel
- ⑩ Puzzle Panel
- ⑪ Maze Panel
- ⑫ Balance Steps
- ⑬ 2ft/3ft Fish Climber
- ⑭ Four In A Row Panel
- ⑮ Window Panel
- ⑯ Bongo
- ⑰ Beads & Cups Panel
- ⑱ 4ft Leaf Step Climber
- ⑲ World Map Panel (Below)
- ⑳ 5ft Sectional Slide Right Turn



W/O

00



32



33

ATLANTA | QSWP-350038

Ages: 2-5 & 5-12

Fall Height: 48"

Use Zone: 41'x35'

Equipment Size: 29'x22'8"

Timbers: 33

NATURE



PRIMARY

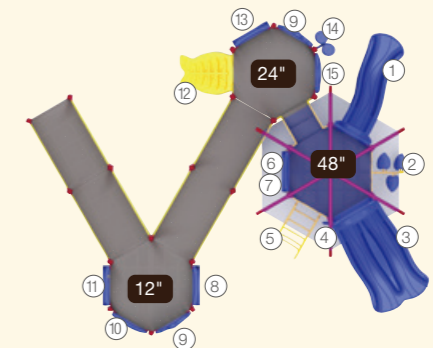

- ① 4ft Single Slide
- ③ 4ft Double Slide
- ⑤ 4ft Arch Climber
- ⑦ Saddle Seat (Below)
- ⑨ Safety Panel
- ⑪ Gears Panel
- ⑬ Four In A Row Panel
- ⑮ Beads & Cups Panel

- ② 4ft Leaf Step Climber
- ④ Rain Wheel
- ⑥ ABC Panel(Above)
- ⑧ World Map Panel
- ⑩ Maze Panel
- ⑫ 2ft/3ft Fish Climber
- ⑭ Bongo

WiseTOT Quick Ship

Need a playful upgrade in a pinch? WiseTOT Quick Ship playgrounds are the ultimate solution for creating vibrant, engaging play spaces on a tight timeline. Designed especially for toddlers, these structures bring colorful excitement and imaginative fun to every corner of your facility—ready to ship and install in no time!

The WiseTOT series is all about exploration and growth. With playful designs that spark curiosity, each structure incorporates sensory-rich activities that encourage little ones to see, hear, touch, and move. Sensory processing is key to developing fine motor skills, emotional regulation, and healthy habits that help children learn to identify and manage their feelings—skills that last a lifetime.

Built to endure years of joyful play, WiseTOT playgrounds are packed with shapes, colors, and interactive moving parts to keep curious minds and active bodies engaged. From spinning wheels to bright textures, every detail stimulates creativity and promotes healthy development while delivering endless fun. Bring big smiles and endless adventures to your little explorers with WiseTOT Quick Ship—a playful solution that's as durable, exciting, and fast as it gets!



Scan above to learn more



Quick Ship



WiseTOT

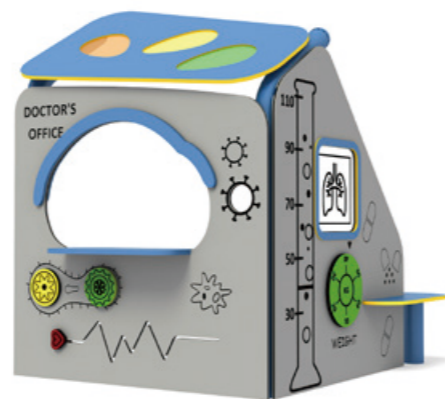

WISE DOC
QS76-21078

Ages: 2-5
Equipment Size: 5' x 5'



WISE FIRE HOUSE
QS76-21076

Ages: 2-5
Equipment Size: 5' x 5'



WISE GARDENER
QS76-21075

Ages: 2-5
Equipment Size: 5' x 5'



Play & Go



ZOOMSTER
QSYJ001366

Ages: 2-5
Equipment Size: 5'8" x 3'5" x 3'11"



SKY COPTER SAM
QSYJ001367

Ages: 2-5
Equipment Size: 6'9" x 4'8" x 3'11"



CHARLIE THE CHOOCHOO TRAIN
QSYJ001368

Ages: 2-5
Equipment Size: 6'1" x 4' x 4'3"



TUGBOAT TOM
QSYJ001370-V01

Ages: 2-5
Equipment Size: 6'9" x 3'4" x 3'5"



BERNICE THE BUS
QS76-21094

Ages: 2-5
Equipment Size: 9' x 5'9" x 4'10"



HAPPY HARVESTER
QSYJ001318-V02

Ages: 2-5
Equipment Size: 5'10" x 3' x 4'



7 SEAS
QSYJ001320-V03

Ages: 2-5
Equipment Size: 6'5" x 3'1" x 2'4"

RETRO Play & Go



FRANNY THE FIRE TRUCK
QSYJ001369

Ages: 2-5
Equipment Size: 6'7" x 4' x 4'





3.5



ASHTON | QSWP-350055

Ages: 6-23 Months
 Fall Height: 24"
 Use Zone: 19'x23'
 Equipment Size: 12'4"x14'8"
 Timbers: 19

NATURE PRIMARY

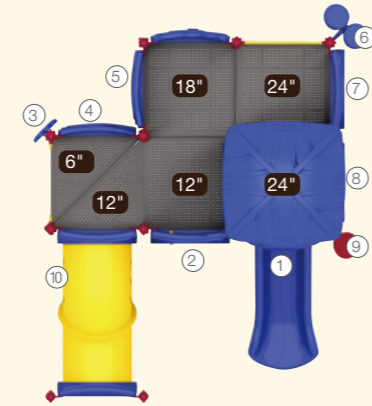

- ① 2ft Single Slide
- ② Gears Panel
- ③ Rain Wheel
- ④ Maze Panel
- ⑤ Beads & Cups Panel
- ⑥ Bongo
- ⑦ World Map Panel
- ⑧ Large Window Panel
- ⑨ PE Stool
- ⑩ Inclined Crawl Tunnel



3.5



BITTERROOT | QSWP-350051

Ages: 6-23 Months
 Fall Height: 12"
 Use Zone: 22'x20'
 Equipment Size: 15'2"x13'5"
 Timbers: 18

NATURE PRIMARY

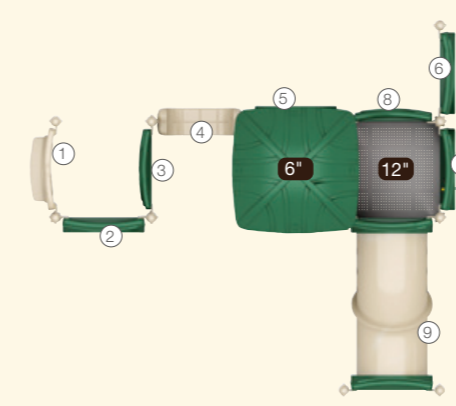

- ① Counter Panel
- ② Four In A Row Panel
- ③ Maze Panel
- ④ Saddle Seat
- ⑤ Big Window Panel
- ⑥ World Map Panel
- ⑦ Maze Panel
- ⑧ Puzzle Panel
- ⑨ Inclined Crawl Tunnel



3.5



HIDEOUT | QSWP-350054

Ages: 6-23 Months
 Use Zone: 18'x15'
 Equipment Size: 11'4"x8'5"
 Timbers: 16

NATURE PRIMARY

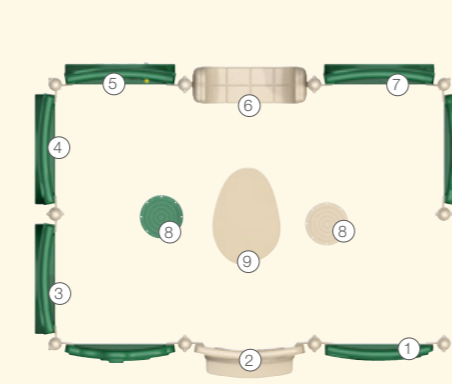

- ① Maze Panel
- ② Counter Panel
- ③ Four In A Row Panel
- ④ ABC Panel
- ⑤ Gears Panel
- ⑥ Saddle Seat
- ⑦ World Map Panel
- ⑧ 1ft Single Trunk Climber
- ⑨ PE Table



FALKVILLE | QSWP-350049

Ages: 6-23 Months
 Fall Height: 24"
 Use Zone: 19'x22'
 Equipment Size: 12'3"x14'2"
 Timbers: 18

NATURE PRIMARY

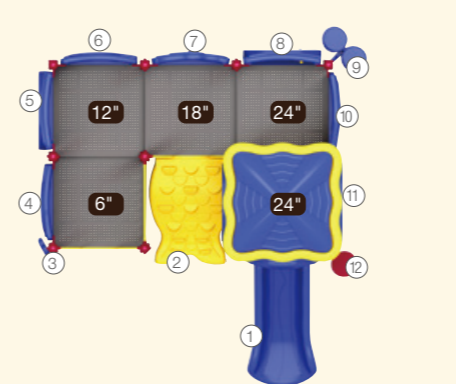

- ① 2ft Sectional Slide
- ② 2ft/3ft Fish Climber
- ③ Rain Wheel
- ④ Puzzle Panel
- ⑤ ABC Panel
- ⑥ Maze Panel
- ⑦ Safety Panel
- ⑧ Gears Panel
- ⑨ Bongo
- ⑩ Beads & Cups Panel
- ⑪ Window Panel
- ⑫ PE Stool

3.5





- 3.5
- Accessibility icon
- 33-37
- 10
- Truck icon

ASTER | QSWP-350050

Ages: 6-23 Months
 Fall Height: 24"
 Use Zone: 19'x22'
 Equipment Size: 12'4"x12'8"
 Timbers: 19

NATURE **PRIMARY**

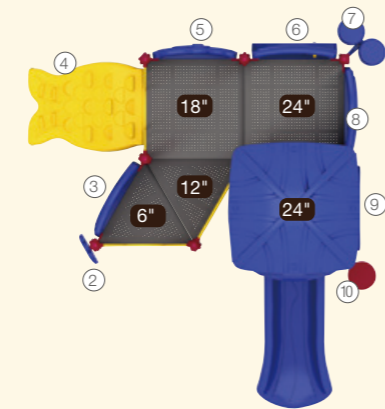

- ① 3ft Single Slide
- ② Rain Wheel
- ③ Puzzle Panel
- ④ 2ft/3ft Fish Climber
- ⑤ Safety Panel
- ⑥ Gears Panel
- ⑦ Bongo
- ⑧ Beads & Cups Panel
- ⑨ Clear Panel
- ⑩ PE Stool



- 3.5
- Accessibility icon
- 8-12
- 10
- Truck icon

SEQUOIA | QSWP-350057

Ages: 6-23 Months
 Use Zone: 26'x11'
 Equipment Size: 26'3"x12'3"
 Timbers: 19

NATURE **PRIMARY**

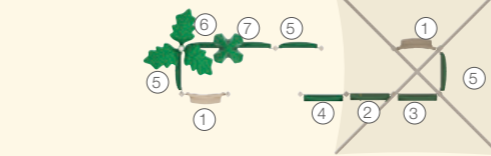

- ① Counter Panel
- ② Gears Panel
- ③ ABC Panel
- ④ Four In A Row Panel
- ⑤ Puzzle Panel
- ⑥ Beads & Cups Panel
- ⑦ Maze Panel

WIGGLE WORM | QSWP-350047

Ages: 6-23 Months
 Use Zone: 21'x14'
 Equipment Size: 14'7"x7'11"
 Timbers: 18

NATURE **PRIMARY**

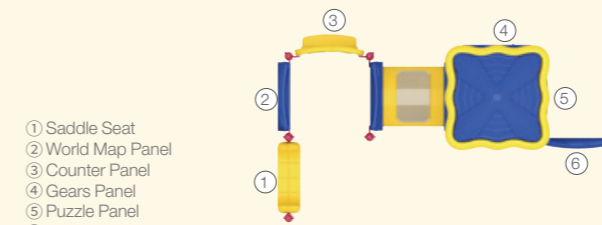

- ① Saddle Seat
- ② World Map Panel
- ③ Counter Panel
- ④ Gears Panel
- ⑤ Puzzle Panel
- ⑥ Maze Panel



- 3.5
- Accessibility icon
- 10-14
- 10
- Truck icon



- 3.5
- Accessibility icon
- 17-22
- 10
- Truck icon

YESTERYEARS | QSWP-350007

Ages: 6-23 Months
 Use Zone: 18'x21'
 Equipment Size: 11'9"x15'
 Timbers: 18

NATURE **PRIMARY**

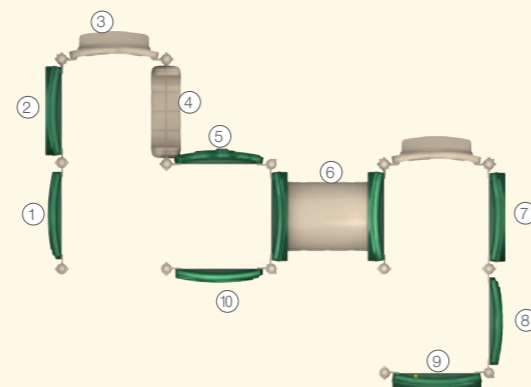

- ① Puzzle Panel
- ② Four In A Row Panel
- ③ Counter Panel
- ④ Saddle Seat
- ⑤ Safety Panel
- ⑥ Crawl Tunnel
- ⑦ ABC Panel
- ⑧ Maze Panel
- ⑨ Gears Panel
- ⑩ Beads & Cups Panel

GALILEO | QSWP-350052

Ages: 6-23 Months
 Use Zone: 17'x18'
 Equipment Size: 10'3"x11'11"
 Timbers: 15

NATURE **PRIMARY**

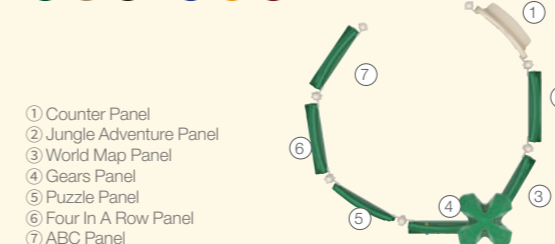

- ① Counter Panel
- ② Jungle Adventure Panel
- ③ World Map Panel
- ④ Gears Panel
- ⑤ Puzzle Panel
- ⑥ Four In A Row Panel
- ⑦ ABC Panel



- 3.5
- Accessibility icon
- 11-15
- 10
- Truck icon



3.5



MADELINE | TOT35CL-0004-121123

Ages: 6-23 Months
 Fall Height: 24"
 Use Zone: 24'x14'
 Equipment Size: 16'2"x7'3"
 Timbers: 18

HIGH TIDE

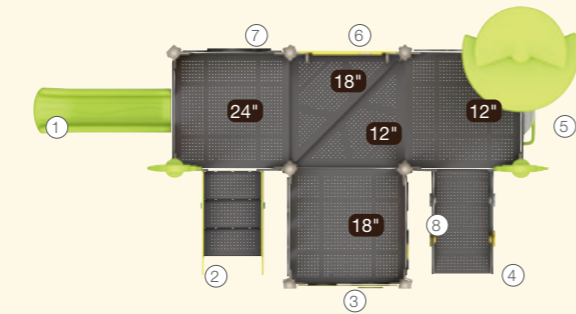

- ① 2ft Single Slide
- ② 2ft Stairs
- ③ PE Turntable Panel
- ④ 1ft Ramp
- ⑤ PE Bubble Window Panel
- ⑥ PE Tic-tac-toe Panel
- ⑦ PE Tri-window Panel
- ⑧ PE Duo-window Panel



3.5



GNOMES HUT | TOT35CL-0011-121123

Ages: 6-23 Months
 Fall Height: 24"
 Use Zone: 26'x17'
 Equipment Size: 19'1"x6'6"
 Timbers: 19

HIGH TIDE

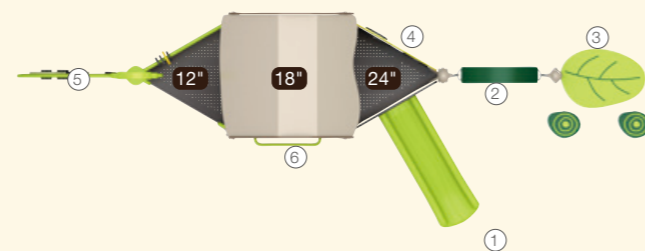

- ① 2ft Single Slide
- ② Growth Ring Stool
- ③ Leaf Table
- ④ PE Turntable Panel
- ⑤ Arch Panel
- ⑥ PE Duo-window Panel



DAHLIA | TOT35CL-0003-77121

Ages: 6-23 Months
 Fall Height: 24"
 Use Zone: 22'x24'
 Equipment Size: 15'5"x14'6"
 Timbers: 18

MEMORY

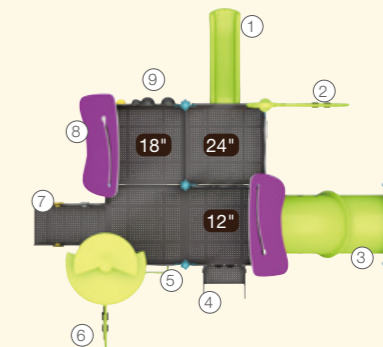

- ① 2ft Single Slide
- ② Arch Climbing Panel
- ③ Inclined Crawl Tunnel
- ④ Inclined Crawl Tunnel
- ⑤ PE Duo-window Panel
- ⑥ Arch Panel
- ⑦ 1ft Ramp
- ⑧ PE Numbers & Shapes Panel
- ⑨ PE Music Panel
- ⑩ PE Turntable Panel



WiseNEX Quick Ship

Many playgrounds fall short—lacking the challenges kids need to stay engaged and active. That's where WiseNEX Quick Ship playgrounds come in! Perfect for communities seeking adventurous, physically challenging play, WiseNEX structures combine imaginative design with exciting activities.

With a dynamic mix of climbing, hanging, and balance sections, these playgrounds encourage kids to test their strength, coordination, and problem-solving skills. From scaling ropes to mastering tricky balance challenges, every element builds muscular endurance, body awareness, and sensory processing while keeping kids entertained.

For communities ready to inspire kids to move, grow, and play smarter and harder, WiseNEX Quick Ship delivers. Fast shipping, endless fun, and a whole lot of movement. Let the adventure begin!

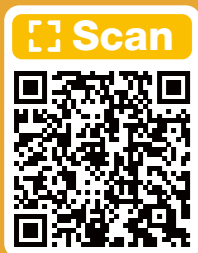

Scan above to learn more



Quick Ship



WiseNEX



ADA



AKRON | QSFS-CL0036

Ages: 5-12
Fall Height: 84"
Use Zone: 40'x28'
Equipment Size: 27'2" x 15'10"
Timbers: 31

NATURE



PRIMARY

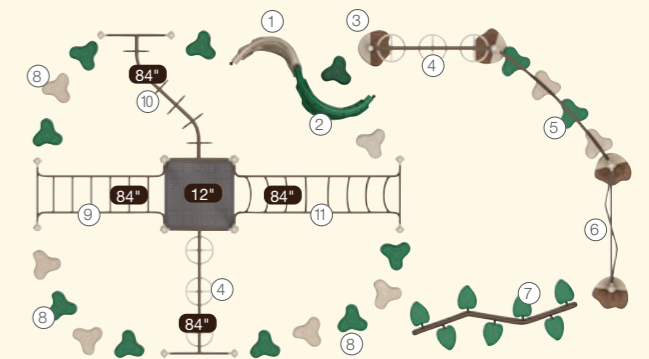

- ① Moab Rock Climber - S
- ② Moab Rock Climber - L
- ③ Bear Step
- ④ Single Post Overhead Rotating Rings
- ⑤ 4 Clover Steps Bridge
- ⑥ S Balance Bridge
- ⑦ Leaf Balance Steps
- ⑧ Clover Step
- ⑨ Challenge Ladder
- ⑩ Zig Zag Overhead Rings
- ⑪ Invert Arch Ladder

DALLAS | QSFS-CL0013

Ages: 5-12
 Fall Height: 84"
 Use Zone: 44'x30'
 Equipment Size: 31'x7'18"

NATURE **PRIMARY**

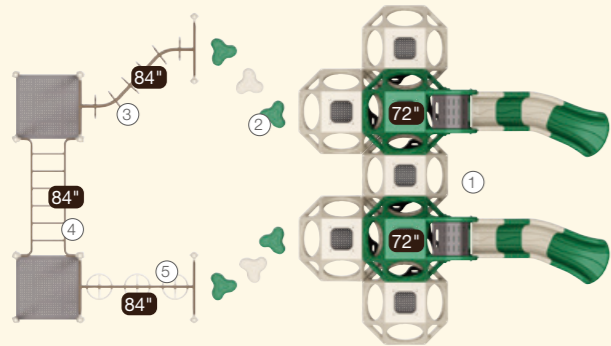

- ① Double Trouble Qube
- ② 6" Clover Step
- ③ Zig Zag Overhead Rings
- ④ Challenge Ladder
- ⑤ Overhead Rotating Rings



THE CHALLENGER | QSFS-CL0014

Ages: 5-12
 Fall Height: 84"
 Use Zone: 28'x31'
 Equipment Size: 15'11"x18'1"

NATURE **PRIMARY**

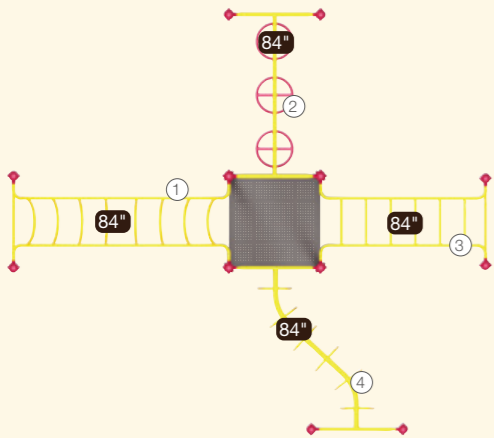

- ① Invert Arch Ladder
- ② Overhead Rotating Rings
- ③ Challenge Ladder
- ④ Zig Zag Overhead Rings



BODEN | QSFS-CL0039

Ages: 2-5
 Fall Height: 84"
 Use Zone: 32'x32'
 Equipment Size: 20'7"x19'4"
 Timbers: 27

NATURE **PRIMARY**

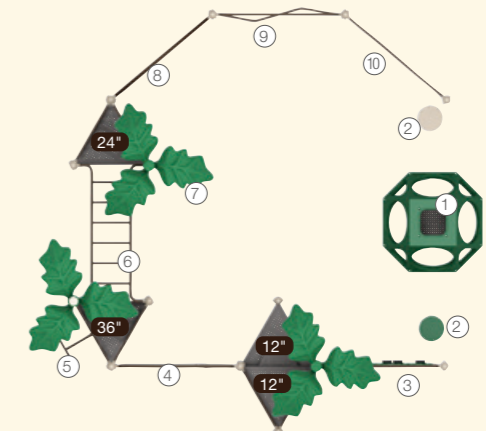

- ① Qubest Section
- ② Single Trunk Climber
- ③ Net Climber - Grass & Ladybug
- ④ Net Climber - Ladder
- ⑤ 3ft Snake Climber
- ⑥ Challenge Ladder
- ⑦ Palm Topper
- ⑧ Honeycomb Net Climber
- ⑨ S Balance Bridge
- ⑩ Vertical Net Link



WiseFREE

Quick Ship

Many playgrounds leave empty spaces that lack purpose, flow, or excitement. Wisdom's WiseFREE Freestanding items are the perfect solution to fill in gaps, connect separate play areas, or create entirely new play zones with ease. Featuring swing sets, slides, qubes, and more, these versatile pieces can be used on their own or combined with existing playgrounds to design a cohesive, unique, and engaging play environment.

Ideal for schools, multi-family housing, parks, and other organizations, WiseFREE items deliver quality, creativity, and functionality without the wait. Standard delivery is just 3-5 days from the time you order, making them a fast and efficient option to enhance your facility on a tight schedule.

With ADA-compliant options available, these freestanding pieces ensure inclusive play for everyone while adding flexibility and flow to any playground. Whether you're creating a new area or expanding an existing space, WiseFREE Freestanding items offer a simple, impactful solution that brings play to life—quickly and seamlessly.



Scan above to learn more



Quick Ship



3.5" Post



ADA



ARCH POST SWING

QSAS-350801 | Color Option: ● ●



BUCKET TREE SWING

QSSPS-0801-TS | Color Option: ● ●



SINGLE POST SWING W/TOT ARM

QSSPS-0801-1A | Color Option: ● ●



ADA SEAT
Color Option: ● ●



FULL BUCKET SEAT



BELT SEAT
Color Option: ● ● ● ● ●



1FT GALVANIZED STEEL CHAIN



SINGLE CLEVIS CONNECTOR

Number	Description	Use Zone
AS-350801	3.5" Arch Swing Frame 8ft-1 Bay	24'x32'
AS-350802	3.5" Arch Swing Frame 8ft-2 Bay	36'x32'
AS-350803	3.5" Arch Swing Frame 8ft-3 Bay	48'x32'
AS-350804	3.5" Arch Swing Frame 8ft-4 Bay	60'x32'
SPS-0801	5" Single Post Swing 8ft-1 Bay	24'x32'
SPS-0802	5" Single Post Swing 8ft-2 Bay	36'x32'
SPS-0803	5" Single Post Swing 8ft-3 Bay	48'x32'
SPS-0804	5" Single Post Swing 8ft-4 Bay	60'x32'
SPS-0801-1A	5" Single Post Swing 8ft 1- Bay W/ARM	30'x32'
SPS-0801-TS	5" Single Post Swing Bucket Tree Swing	30'x32'
SS-0011	Full Bucket Seat & Galvanized Steel Chain Set	Sold Separately
SS-0012	Belt Seat & Galvanized Steel Chain Set	Sold Separately
SS-0190G-JS	Adaptive Swing Seat (Green)	Sold Separately
SS-0190R-JS	Adaptive Swing Seat (Red)	Sold Separately

Qubes

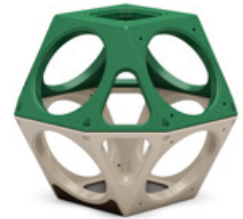

QUBEST | QSQB-210001

Age: 2-5 & 5-12
 Fall Height: 48"
 Use Zone: 17' x 17'
 Equipment Size: 4'6" x 4'6" x 6'7"

NATURE PRIMARY



SKQUBE | QSQB-210002

Age: 5-12
 Fall Height: 72"
 Use Zone: 24' x 29'
 Equipment Size: 11'3" x 16'5" x 9'5"

NATURE PRIMARY



Q | QSQB-21097

Age: 2-5 & 5-12
 Fall Height: 24"
 Use Zone: 17' x 17'
 Equipment Size: 4'6" x 4'6" x 2'1"

NATURE PRIMARY

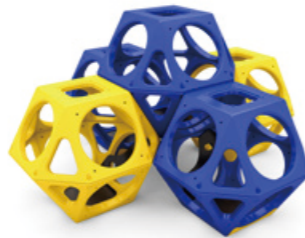

RUBY QUBE | QSQB-210004

Age: 5-12
 Fall Height: 72"
 Use Zone: 23' x 23'
 Equipment Size: 11'3" x 11'3" x 8'8"

NATURE PRIMARY



Slides



**6' FREESTANDING SINGLE SLIDE
 QSFS-SL72031LS**

Ages: 5-12
 Fall Height: 72"
 Use Zone: 27' x 16'
 Equipment Size: 14'8" x 3'11" x 10'1"

NATURE PRIMARY



**5' FREESTANDING SINGLE SLIDE
 QSFS-SL6001WC**

Ages: 5-12
 Fall Height: 60"
 Use Zone: 24' x 17'
 Equipment Size: 11'6" x 4'5" x 9'1"

NATURE PRIMARY

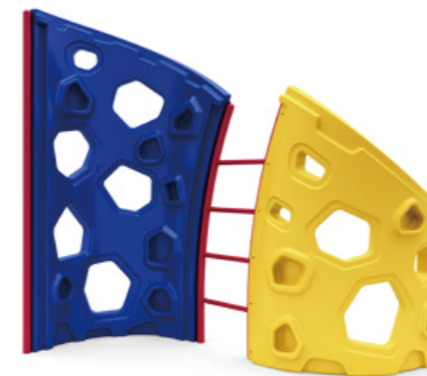

DELICATE ARCH | QSMR-210002

Ages: 5-12
 Fall Height: 42"
 Use Zone: 20' x 17'
 Equipment Size: 7'10" x 5' x 6'10"

PRIMARY



Moab Rock

BALANCED ROCK | QSMR-210001

Ages: 5-12
 Fall Height: 42"
 Use Zone: 20' x 16'
 Equipment Size: 7'1" x 3'4" x 6'10"

NATURE





HORSE RIDER
QSSR-21008

Ages: 2-5
Use Zone: 15'x13'
Equipment Size:
2'10" x 1' x 2'8"



BEE RIDER
QSSR-21007

Ages: 2-5
Use Zone: 15'x13'
Equipment Size:
2'10" x 1' x 2'5"



WISESAW - DUO
QSSR-21005

Ages: 2-5 & 5-12
Use Zone: 12'x8'
Equipment Size: 5'2" x 1'5" x 2'4"



FIRE TRUCK RIDER
QSSR-21006

Ages: 2-5
Use Zone: 15'x13'
Equipment Size:
2'11" x 1' x 2'6"



PONY RIDER
QSSR-21004

Ages: 2-5
Use Zone: 15'x14'
Equipment Size:
2'8" x 1'3" x 2'10"



ATV RIDER
SR-21039-110

Ages: 2-5
Use Zone: 16'x14'
Equipment Size: 3'9" x 2' x 2'8"



BULLDOZER RIDER
SR-21040-121

Ages: 2-5
Use Zone: 16'x14'
Equipment Size: 3'3" x 1'5" x 3'1"



CATERPILLAR CRAWL
TUNNEL-UNIT
QSHW1-S1A308

Ages: 2-5
Use Zone: 10'x10'
Equipment Size:
3'11" x 3'11" x 4'6"





CATERPILLAR CRAWL
TUNNEL-COMPLETE SET
QSHW1-S1A309

Ages: 2-5
Use Zone: 15'x12'
Equipment Size:
8'10" x 5'7" x 4'6"

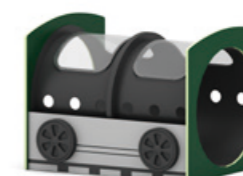

TRAIN CRAWL
TUNNEL-ENGINE
QSHW1-S310-V01

Ages: 2-5
Use Zone: 11'x10'
Equipment Size:
4'4" x 3'5" x 4'9"



TRAIN CRAWL TUNNEL-
CARRIAGE
QSHW1-S311-V01

Ages: 2-5
Use Zone: 11'x10'
Equipment Size:
4'1" x 3'5" x 3'2"



STAND & SPIN
QS75-21003-110
 Ages: 5 -12
 Use Zone: 15' x 15'



LOTUS SPINNER
QS75-21004-112
 Ages: 5 -12
 Use Zone: 14' x 14'



WISE TOSS
QSLs-JSQC006
 Ages: 2-12
 Use Zone: 3' x 3'
 Color Option:



PLAYGROUND BALLS
(SET OF 6)
QS72-21032



GFRc TIMBER
CRAWL TUNNEL
QS72-22001
 Ages: 2-5 & 5-12
 Use Zone: 10' x 9'



GFRc STUMP JUMP
63-21078
 Ages: 2-5 & 5-12
 Use Zone: 12' x 8'



FROG HOPPER
QSFS-CL0019N
 Ages: 2-5 & 5-12
 Use Zone: 13' x 13'



TETHERBALL SET
FS-CL3524-116BN



LEAF BALANCE STEPS
QS75-21012-111
 Ages: 2-5 & 5-12
 Use Zone: 20' x 17'



BALANCE BEAM
QS75-21009-110
 Ages: 2-5 & 5-12
 Use Zone: 19' x 13'



SM
WISE BLACKBOARD
QS78-21001
 Equipment Size: 4'3" x 1'



SM
WISE WHITE BOARD
QS78-21002
 Equipment Size: 4'3" x 1'



SM
WISE PAINT BOARD
QS78-21003
 Equipment Size: 4'3" x 1'



WILD BUNCH
QSGP2-T072



CAREY THE
CARROT
QS78-21006
 Equipment Size:
 2'6" x 5"



ALLIE THE
APPLE
QS78-21007
 Equipment Size:
 3' x 5"



FIONA THE
FLOWER(BLUE)
QS78-21008
 Equipment Size:
 2'11" x 4"



FIONA THE
FLOWER(PURPLE)
QS78-21008-77
 Equipment Size:
 2'11" x 4"



FIONA THE
FLOWER(ORANGE)
QS78-21008-121
 Equipment Size:
 2'11" x 4"



FIONA THE
FLOWER(RED)
QS78-21008-118
 Equipment Size:
 2'11" x 4"



FIONA THE
FLOWER(LIME)
QS78-21008-122
 Equipment Size:
 2'11" x 4"



BONGO DRUMS
QS72-22004
 Equipment Size: 3'5" x 9"



RAINBOW XYLOPHONE
QS72-22003
 Equipment Size: 2' x 1'6"



SPLIT RAINBOW XYLOPHONE
QS72-22002
 Equipment Size: 2'8" x 1'4"



IG
ALTO I **QSFS-WP0001N**
 Equipment Size: 3'10" x 6"

WiseSITE

Quick Ship

Many playgrounds lack key elements that turn spaces from ordinary to functional and enjoyable. WiseSITE Quick Ship site furnishings are designed to address these gaps, offering practical and purposeful items often overlooked but essential to a complete playground.

From inclusive picnic tables and seating to waste bins, bike racks, and timbers, WiseSITE products enhance playgrounds by providing comfort, accessibility, and functionality for children, caregivers, and the community. Delivered in just 3-5 days, they're ideal for schools, parks, multi-family housing, and more.

Pair WiseSITE Quick Ship items with Quick Ship playgrounds and WiseFREE freestanding items to create cohesive, purpose-driven spaces that meet all needs. Solve the common issue of missing site furnishings with WiseSITE—because a complete playground is about more than just play structures.

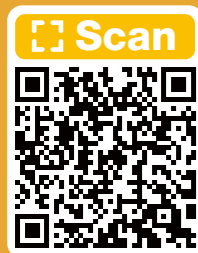

Scan above to learn more



Quick Ship

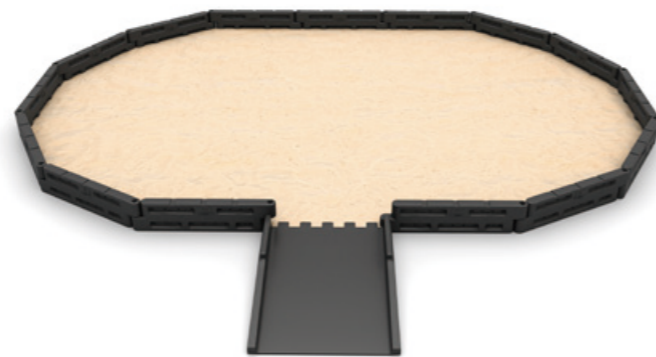

8" TIMBER BORDER W/SPIKE
QSTB-5208-2B2
 Equipment Size:4'3" x 4"

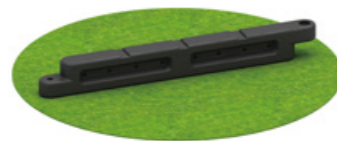

12" TIMBER BORDER W/SPIKE
QSTB-5212-2B2
 Equipment Size:4'4" x 4"



HALF ADA RAMP
QSTB-6244-2B2
 Equipment Size:5'2" x 3'9"

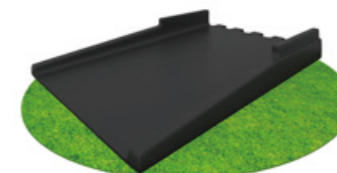

6' RECTANGULAR PICNIC TABLE PERFORATED PATTERN
QSSAP-21001-110
 Equipment Size:6'1" x 5'2"



6' BENCH W/BACK PERFORATED PATTERN
QSSAP-21002-IG-110
 Equipment Size:6'2" x 3'



WISEBIN
QS72-21021-110
 Equipment Size:1'11" x 1'11"



SINGLE BIKE RACK
QS72-21015-131
 Equipment Size:1'3" x 3"



DOUBLE BIKE RACK
QS72-21016-131
 Equipment Size:3'2" x 3"



WISEBIN WITH RAIN COVER
QS72-21022-110
 Equipment Size:1'11" x 1'11"

WiseTOWER

The WiseTOWER series offers two immersive and engaging themes—Ocean and Forest—each designed to spark imagination and encourage active play in young children. These thoughtfully crafted environments bring the beauty and excitement of nature to life, creating a dynamic and stimulating space where children can explore, climb, and develop essential physical and cognitive skills.

At the heart of these playgrounds is a 3D multi-layer vertical climbing structure, carefully designed to maximize play value while maintaining a compact footprint. By incorporating distinct thematic elements and a variety of climbing challenges, these structures provide endless opportunities for movement, coordination, and strength-building. The integration of peripheral wooden barriers enhances the aesthetic appeal while ensuring safety, reinforcing a natural and eco-friendly design that blends seamlessly with outdoor environments.

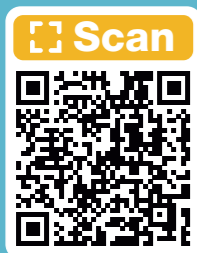

Scan above to learn more

- 061 WiseTOWER Summit Series
- 069 WiseTOWER SkyTower series

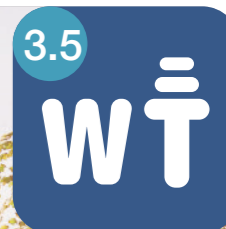

www.wisdomplaygrounds.com

ALDEN'S ADVENTURE WT35NS-0005

Ages: 5-12

Fall Height: 84"

Use Zone: 48'x41'

Equipment Size: 32'x27'2"x22'1"

RUSH



Floor-to-ceiling Bay Window



Bay Window



Rope Game

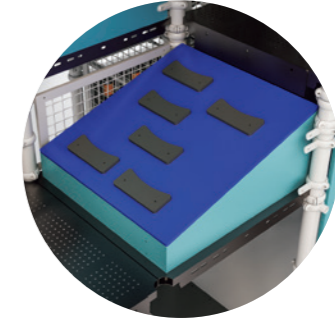

Deck Slope



Upright Rocker Climber

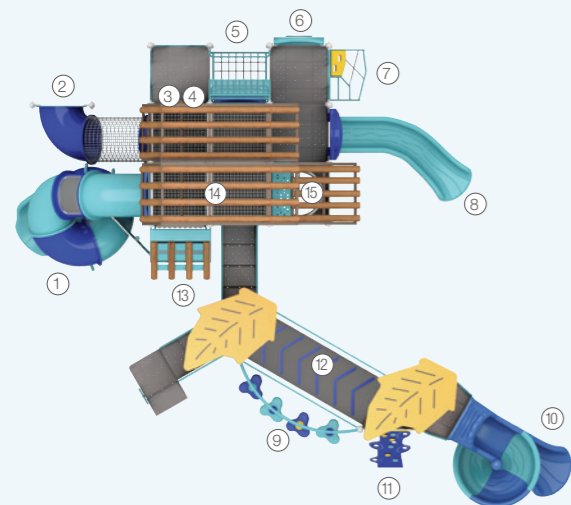

- ① 7ft Spiral Tube Slide Left Turn
- ② Net Crawl Tunnel
- ③ Marble Panel
- ④ Bay Window w/Barrier
- ⑤ Inclined Net Bridge 42" w/Handrails
- ⑥ Vortex Effects Panel
- ⑦ 4ft Power Frame
- ⑧ 5ft Single Slide
- ⑨ Clover Steps with Orbs
- ⑩ 6ft Spiral Slide
- ⑪ PE Rock Climber
- ⑫ Belt Bridge w/Handrails
- ⑬ Twist-a-Tile Panel
- ⑭ Upright Rocker Climber
- ⑮ 6ft Upright Net Crawl Tunnel



Inclined Net Crawl Tunnel



Multi Functional Panels



Upright Net Crawl Tunnel



Net Deck w/2-Hole





TUMBLE TOWER WT35NS-0003

Ages: 5-12
Fall Height: 48"
Use Zone: 33'x28'
Equipment Size: 17'8"x13'8"x23'8"

LIVELY

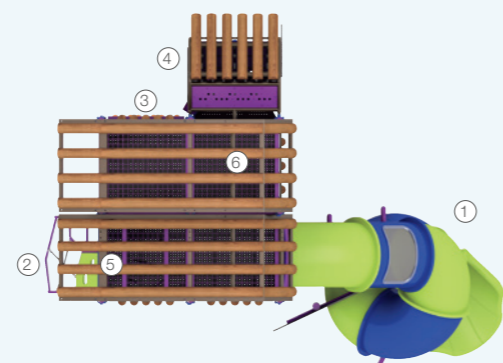

- ① 7ft Spiral Tube Slide Left Turn
- ② 4ft Power Frame Climber
- ③ Twist-a-Tile Panel
- ④ Marble Panel
- ⑤ 1-Unit Rope Game
- ⑥ 4ft PE Upright Rocker Climber



EXPLORER'S LOOKOUT WT35NS-0004

Ages: 5-12
Fall Height: 84"
Use Zone: 43'x35'
Equipment Size: 26'4"x21'11"x22'1"

URBAN SPROUT

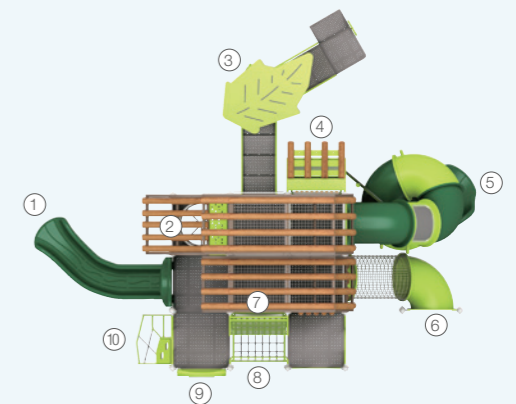

- ① 5ft Single Slide
- ② 6ft Upright Net Crawl Tunnel
- ③ MARBLE Panel
- ④ Twist-a-Tile Panel
- ⑤ 7ft Spiral Tube Slide Left Turn
- ⑥ Net Crawl Tunnel
- ⑦ Moving Balls Panel
- ⑧ Net Bridge
- ⑨ Vortex Effects Panel
- ⑩ 4ft Power Frame Climber





TIMBER RUSH WT35NS-0001

Ages: 5-12
Fall Height: 84"
Use Zone: 57'x42'
Equipment Size: 43'5" x 27'3" x 23'8"

RUSH

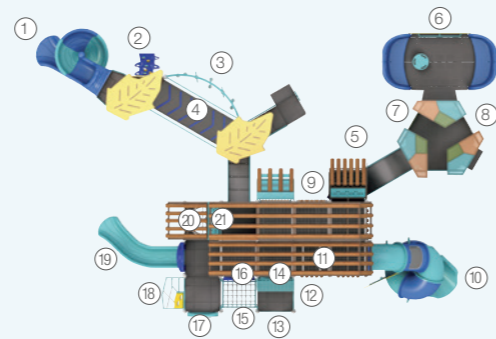

- | | |
|-----------------------------|-----------------------------------|
| ① 6ft Spiral Slide | ⑥ Leaf Climber |
| ③ Rings & Ropes Bridge | ④ Belt Bridge w/Handrails |
| ⑤ Tactile Balls | ⑦ Rock and Roll ON |
| ⑦ Sensory Green Window Worx | ⑧ Sensory Yellow Window Worx |
| ⑨ Twist-a-Tile Panel | ⑩ 7ft Spiral Tube Slide Left Turn |
| ⑪ Net Crawl Tunnel | ⑫ 3ft Upright Rung Climber |
| ⑬ 3ft Upright Net Climber | ⑭ Visual Turnplate Panel |
| ⑮ Net Bridge | ⑯ Moving Balls Panel |
| ⑰ Vortex Effects Panel | ⑱ 4ft Power Frame |
| ⑲ 5ft Single Slide | ⑳ 6ft Upright Net Crawl Tunnel |
| ⑳ Upright Rocker Climber | |

RAPID RIDGE WT35NS-0002

Ages: 5-12
Fall Height: 84"
Use Zone: 50'x36'
Equipment Size: 33'11" x 22' x 23'8"

FLANNEL

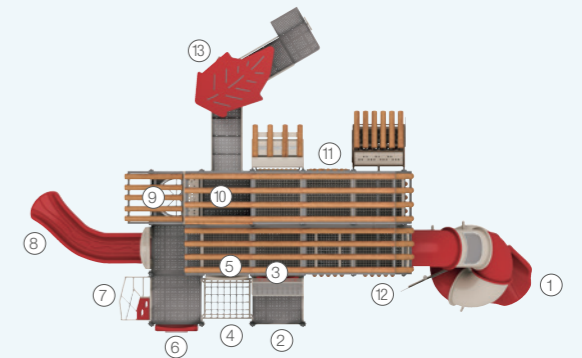

- | | |
|-----------------------------------|---------------------------|
| ① 7ft Spiral Tube Slide Left Turn | ② 3ft Upright Net Climber |
| ③ Visual Turnplate Panel | ④ Net Bridge |
| ⑤ Moving Balls Panel | ⑥ Vortex Effects Panel |
| ⑦ 4ft Power Frame | ⑧ 5ft Single Slide |
| ⑨ 6ft Upright Net Crawl Tunnel | ⑩ Upright Rocker Climber |
| ⑪ Twist-a-Tile Panel | ⑫ Net Crawl Tunnel |
| ⑬ Tactile Balls | |



EVERGREEN TOWER WT35NS-0006

Ages: 5-12
Fall Height: 72"
Use Zone: 48'x25'
Equipment Size: 21'10" x 16'7" x 23'1"

BEACHY

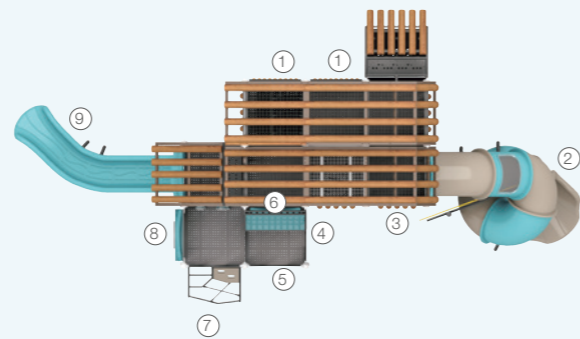

- ① Twist-a-Tile Panel
- ② 7ft Spiral Tube Slide Left Turn
- ③ Net Crawl Tunnel
- ④ 3ft Upright Rung Climber
- ⑤ 3ft Upright Net Climber
- ⑥ Visual Turnplate Panel
- ⑦ 4ft Power Frame Climber
- ⑧ Vortex Effects Panel
- ⑨ 5ft Single Slide



OCEANIC WT35NS-0007

Ages: 5-12
Fall Height: 72"
Use Zone: 48'x41'
Equipment Size: 31'10" x 31'1" x 23'1"

POWER

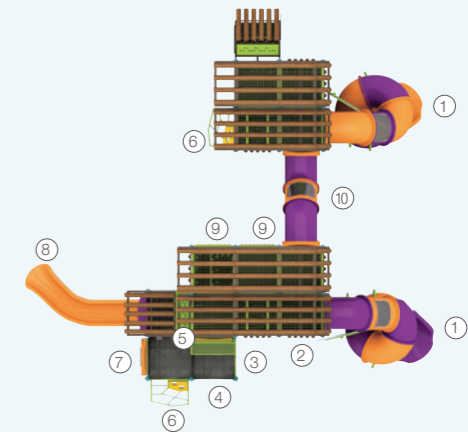

- ① 7ft Spiral Tube Slide Left Turn
- ② Net Crawl Tunnel
- ③ 3ft Upright Rung Climber
- ④ 3ft Upright Net Climber
- ⑤ Visual Turnplate Panel
- ⑥ 4ft Power Frame Climber
- ⑦ Vortex Effects Panel
- ⑧ 5ft Single Slide
- ⑨ Twist-a-Tile Panel
- ⑩ Inclined Crawl Tunnel





**ASPEN SUMMIT
ST35NS-0001**

Ages: 5-12
Fall Height: 84"
Equipment Size: 35'6" x 44'4" x 26'

TUNDRA

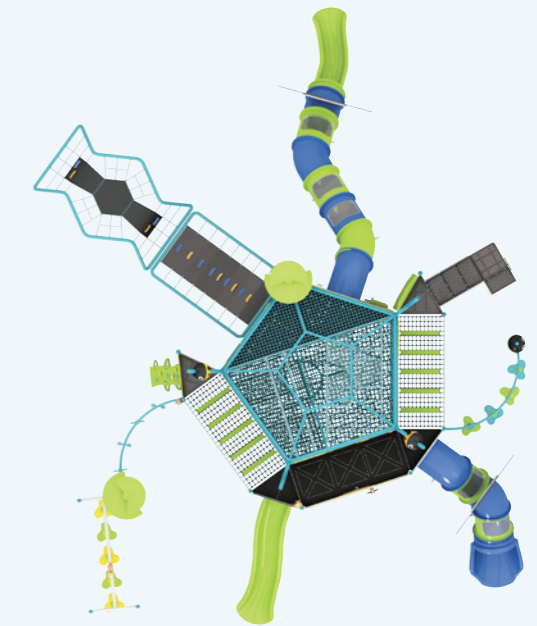

NEW



**HONEYCREST
ST35NS-0002**

Ages: 5-12
Fall Height: 96"
Equipment Size: 45'1"×44'4"×26'

PHARO

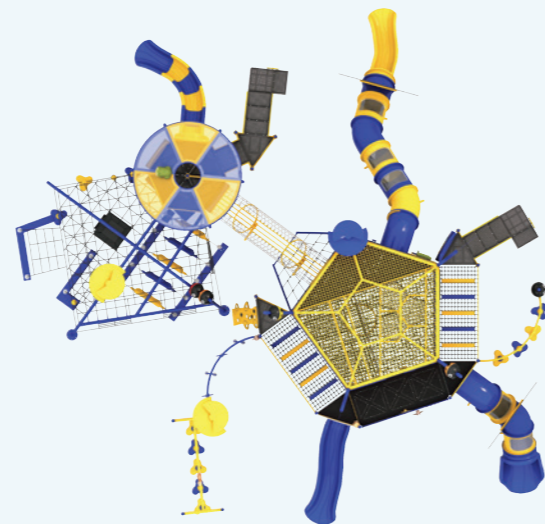

NEW



**HIGHGROVE
ST35NS-0003**

Ages: 5-12
Fall Height: 84"
Equipment Size: 38'1"×44'4"×26'

ATTICUS

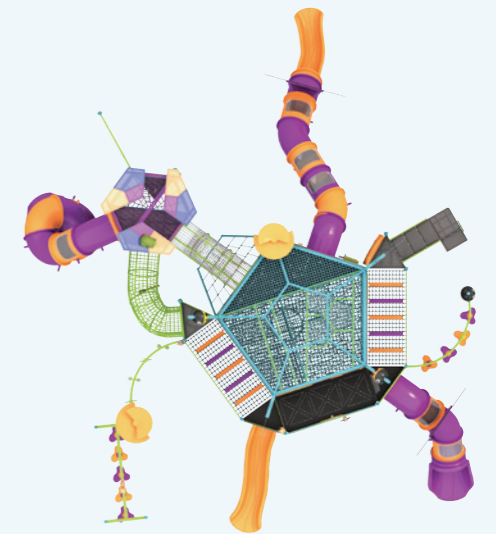

WiseTOT

Designed with toddlers' development in mind, the WiseTOT series creates vibrant, engaging play environments where young children can explore, grow, and thrive. These colorful and playful structures encourage curiosity and discovery, offering endless opportunities to engage their senses and spark imagination.

The WiseTOT series focuses on sensory experiences that are essential for early childhood development. By stimulating sight, sound, and touch, these playgrounds help foster fine motor skills, mood regulation, and emotional awareness—key building blocks for identifying and managing emotions in healthy ways.

Built to withstand the test of time, WiseTOT structures are filled with dynamic shapes, interactive elements, and vibrant colors that captivate young minds and keep them active. Whether climbing, touching, or exploring, children will find endless fun in these thoughtfully designed spaces, making every visit a new adventure in play and learning.

- 075 Lean On Me Series
- 083 WiseTOT Custom
- 087 Retro Play & Go
- 089 WiseTOT - Imagination City



3.5

WT

WiseTOT

Lean On Me Series

The WiseTOT Lean On Me Series was developed to let children release their passion for adventure in a safe environment and cultivate the learning ability to not be afraid of challenges. WiseTOT Imagination City playgrounds are part of the Lean On Me series, which integrates equipment that will keep the imagination going, along with special sensory integration that helps promote the balanced development of children's gross motor abilities and overall sensory abilities.

Imagination City provides the smaller children an option to explore their surroundings more autonomously and with interesting activities. Featuring sensory elements like sight, sound and touch, keeps their minds and bodies engaged. WiseTOT structures are loaded with shapes, colors, and moving parts to provide endless amounts of entertainment. Wisdom's variety of activities comprehensively develop children's different abilities.

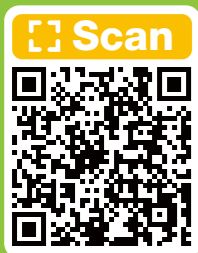

Scan above to learn more



WiseTOT



3.5" Post



ADA



PEBBLE PATCH | TOT35CL-0001

Ages: 6-23 Months
 Fall Height: 24"
 Use Zone: 31'x16'
 Equipment Size: 21'4"x8'7"x8'11"
 Timbers: 20

TROPICAL

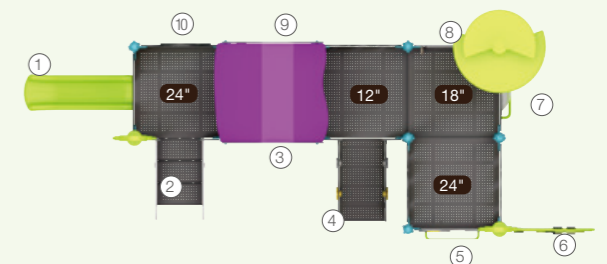

- ① 2ft Single Slide
- ② 2ft Stairs
- ③ PE Turntable Panel
- ④ 1ft Ramp
- ⑤ PE Duo-window Panel
- ⑥ Arch Climbing Panel
- ⑦ PE Bubble Window Panel
- ⑧ PE Tic-tac-toe Panel
- ⑨ PE Numbers & Shapes Panel
- ⑩ PE Tri-window Panel



TOADS PLAY TOT35CL-0005

Ages: 6-23 Months
Fall Height: 24"
Use Zone: 24'x14'
Equipment Size: 14'7"x7'4"x9'2"
Timbers: 18

TROPICAL

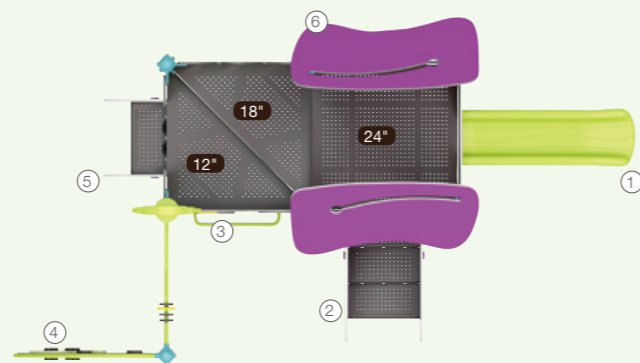

- ① 2ft Single Slide
- ② 2ft Stairs
- ③ PE Duo-window Panel
- ④ Arch Climbing Panel
- ⑤ 1ft Stairs
- ⑥ PE Numbers & Shapes Panel

LITTLE SNUFFY TOT35CL-0009

Ages: 6-23 Months
Fall Height: 24"
Use Zone: 20'x10'
Equipment Size: 10'8"x3'10"x9'2"
Timbers: 14

SUNRISE

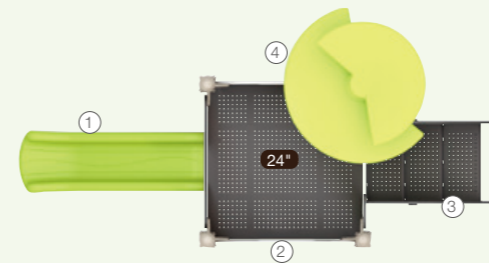

- ① 2ft Single Slide
- ② PE Elephant Panel L
- ③ 2ft Stairs
- ④ PE Elephant Panel R



DAFFODIL TOT35CL-0013

Ages: 6-23 Months
Fall Height: 24"
Use Zone: 20'x18'
Equipment Size: 11'10"x10'2"x9'3"
Timbers: 17

SUNRISE

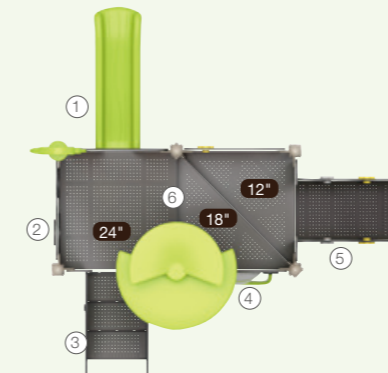

- ① 2ft Single Slide
- ② PE Turntable Panel
- ③ 2ft Stairs
- ④ PE Bubble Window Panel
- ⑤ 1ft Ramp
- ⑥ PE Safety Panel - Dynamic





IRIS
TOT35CL-0002
 Ages: 6-23 Months
 Fall Height: 24"
 Use Zone: 23'x24'
 Equipment Size: 17'3"x15'x3'6"
 Timbers: 21

TRANQUIL

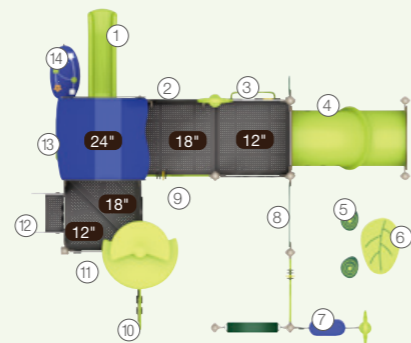

- ① 2ft Single Slide
- ② PE Duo-window Panel
- ③ Growth Ring Stool
- ④ PE Counter Panel
- ⑤ PE Tri-window Panel
- ⑥ PE Numbers & Shapes Panel
- ⑦ PE Bubble Window Panel
- ⑧ PE Tic-tac-toe Panel
- ⑨ Inclined Crawl Tunnel
- ⑩ Leaf Table
- ⑪ PE Hole Panel
- ⑫ Arch Panel
- ⑬ 1ft Stairs
- ⑭ Game Table

COSMOS
TOT35CL-0006
 Ages: 6-23 Months
 Fall Height: 24"
 Use Zone: 20'x17'
 Equipment Size: 10'9"x10'8"x8'8"
 Timbers: 16

TRANQUIL

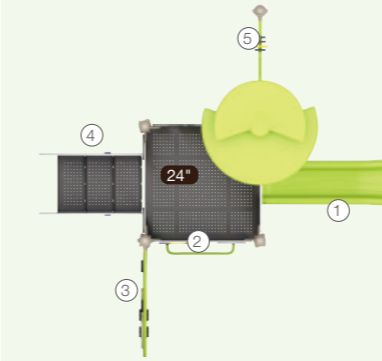

- ① 2ft Single Slide
- ② PE Duo-window Panel
- ③ Arch Panel
- ④ 2ft Stairs
- ⑤ Horizontal Moving Game



POLLYWOGS
TOT35CL-0010
 Ages: 6-23 Months
 Fall Height: 6"
 Use Zone: 18'x14'
 Equipment Size: 11'2"x7'9"x7'3"
 Timbers: 15

TRANQUIL

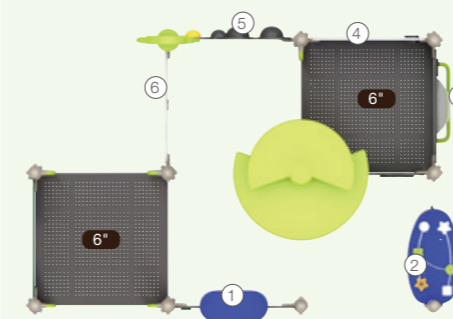

- ① PE Counter Panel
- ② Game Table
- ③ PE Bubble Window Panel
- ④ PE Numbers & Shapes Panel
- ⑤ PE Music Panel
- ⑥ Arch Panel



BEDELIA TOT35CL-0007

Ages: 6-23 Months
Fall Height: 24"
Use Zone: 24'x16'
Equipment Size: 14'6"x8'11"x8'11"
Timbers: 16

HIGH TIDE

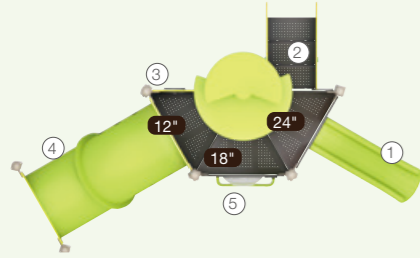

- ① 2ft Single Slide
- ② 2ft Stairs
- ③ PE Turntable Panel
- ④ Inclined Crawl Tunnel
- ⑤ PE Bubble Window Panel



MARIGOLD TOT35CL-0008

Ages: 6-23 Months
Use Zone: 17'x11'
Equipment Size: 10'1"x4'1"x7'9"
Timbers: 13

PARADISE

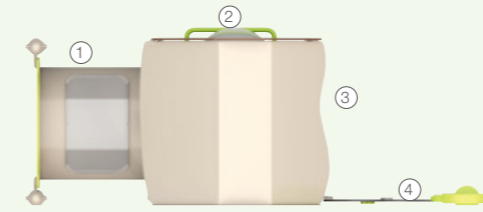

- ① Crawl Tunnel
- ② PE Bubble Window Panel
- ③ PE Tic-tac-toe Panel
- ④ PE Natural Theme Panel



MAISY TOT35CL-0014

Ages: 6-23 Months
Fall Height: 24"
Use Zone: 23'x18'
Equipment Size: 13'2"x11'5"x10'10"
Timbers: 18

HIGH TIDE

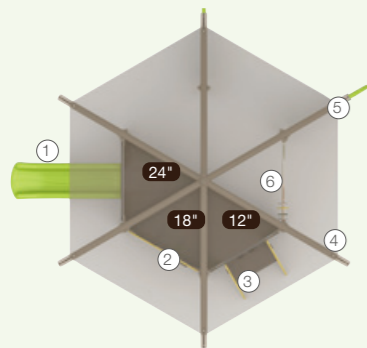

- ① 2ft Single Slide
- ② PE Turntable Panel
- ③ 1ft Stairs
- ④ Arch Panel
- ⑤ Arch Climbing Panel
- ⑥ PE Numbers & Shapes Panel



PETUNIA TOT35CL-0012

Ages: 6-23 Months
Fall Height: 12"
Use Zone: 13'x12'
Equipment Size: 6'9"x5'5"x7'3"
Timbers: 11

PARADISE

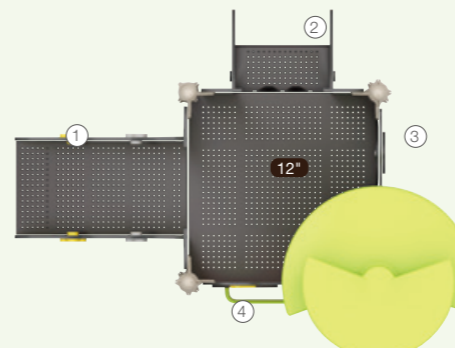

- ① 1ft Ramp
- ② 1ft Stairs
- ③ PE Turntable Panel
- ④ PE Duo-window Panel



WiseTOT Custom

WiseTOT Custom Playgrounds are built to inspire and last, creating dynamic spaces where young children can explore, imagine, and grow together. Designed with toddler development in mind, these custom structures come in a variety of color schemes and are crafted with high-quality materials to ensure both durability and creativity.

With interactive shapes, bright colors, and dynamic moving parts, WiseTOT Custom Playgrounds offer endless entertainment that keeps little ones engaged. Integrated sensory elements like sight, sound, and touch enhance the play experience, promoting balanced development while fostering imagination and creativity.

Perfect for organizations seeking toddler-aged development solutions, WiseTOT Custom designs deliver fun, functionality, and endless adventure for young explorers.



Scan above to learn more



WiseTOT



Custom



3.5" Post



ADA



TIPPY-TOE | PDWP-350090C13

Ages: 6-23 Months
 Fall Height: 24"
 Use Zone: 22'x18'
 Equipment Size: 15'4"x11'11"x12'
 Timbers: 19

TIPPY

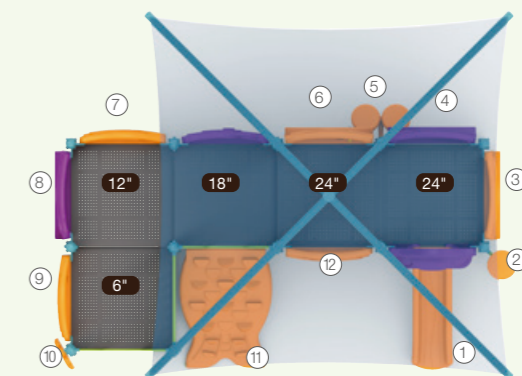

- ① 2ft Single Slide
- ② PE Stool
- ③ Bubble Window Insert
- ④ World Map Insert
- ⑤ Bongo
- ⑥ Gears Insert
- ⑦ Maze Insert
- ⑧ ABC Insert
- ⑨ Puzzle Insert
- ⑩ Rain Wheel
- ⑪ 2ft Fish Climber
- ⑫ Beads & Cups Insert

ZOEY

PDWP-350097C12

Ages: 6-23 Months

Use Zone: 18'x15'

Equipment Size: 12'8"x11'x8'10"

Timbers: 14

JUNGLE JEWEL

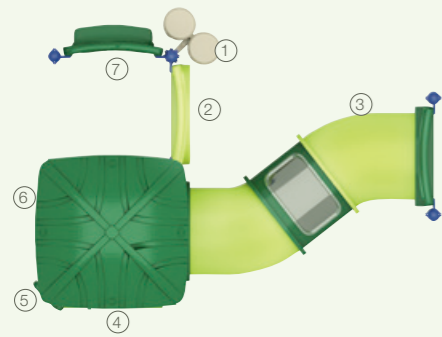

- ① Bongo
- ② Four In A Row Insert
- ③ S-shape Crawl Tunnel
- ④ Gears Insert
- ⑤ Rain Wheel
- ⑥ Saddle Seat
- ⑦ Counter Panel



SWEET MAY

PDWP-350098C11

Ages: 6-23 Months

Fall Height: 24"

Use Zone: 23'x15'

Equipment Size: 13'7"x8'10"x11'

Timbers: 17

WISE

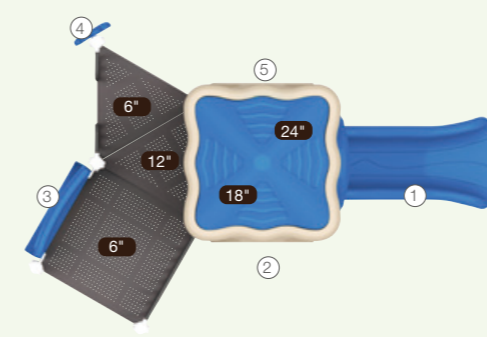

- ① 2ft Single Slide
- ② ABC Insert
- ③ World Map Insert
- ④ Rain Wheel
- ⑤ Bubble Window Insert



TREBLE LEAF

PDWPPE-350001C15

Ages: 2-5

Fall Height: 36"

Use Zone: 32'x24'

Equipment Size: 18'6"x12'1"x12'2"

SUNLIT GROVE

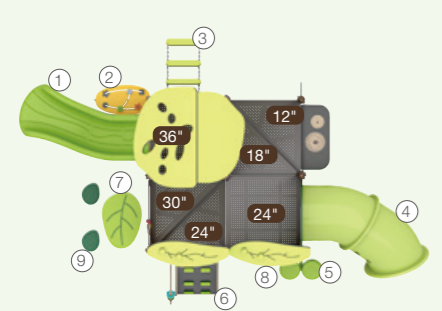

- ① 3ft Sectional Slide Right Turn
- ② Game Table
- ③ Rope Ladder
- ④ Inclined Crawl Tunnel Section Right Turn
- ⑤ Bongo
- ⑥ H60 Arch Grab Climber
- ⑦ Leaf Table
- ⑧ Music Panel
- ⑨ Growth Ring Stool



LITTLE STAR

PDWP-350099C11

Ages: 6-23 Months

Fall Height: 24"

Use Zone: 22'x15'

Equipment Size: 12'7"x8'3"x9'11"

Timbers: 16

ROCKET

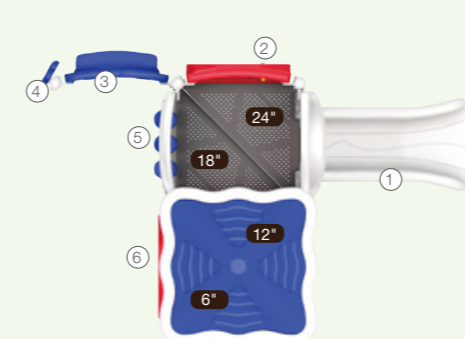

- ① 2ft Single Slide
- ② Gears Insert
- ③ Saddle Seat
- ④ Rain Wheel
- ⑤ Tic-Tac-Toe Insert
- ⑥ Bubble Window Insert



WiseTOT

Retro Play & GO

The WiseTOT Retro Play & Go Series brings excitement and adventure to toddler-aged play areas with unique equipment designed to spark creativity and imagination. Inspired by modes of transportation, these playful structures invite children to embark on thrilling journeys and explore their surroundings in a fun, interactive way.

Built to last and designed with little ones in mind, the Retro Play & Go series offers high-quality, durable equipment that encourages hands-on exploration and endless adventures. Perfect for organizations seeking additional play solutions for young children, these imaginative structures enhance any space, turning simple play into exciting, story-driven experiences.

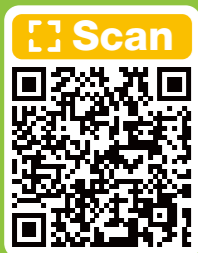

Scan above to learn more



WiseTOT



FIRE ENGINE
YJ001316-V04

Ages: 2-5
Use Zone: 19'x16'
Equipment Size: 6'5" x 3'6" x 4'2"



BEEP JEEP
YJ001317-V03

Ages: 2-5
Use Zone: 18'x15'
Equipment Size: 5'6" x 3'1" x 3'



AIRPLANE
YJ001319-V02

Ages: 2-5
Use Zone: 19'x17'
Equipment Size: 6'7" x 4'10" x 2'8"



TINY ACRES | 76-21112

Ages: 2-5
Use Zone: 21'x18'
Equipment Size: 9'4"x5'9"x5'6"
Fall Height: 48"

PLAYHOUSE CLASSIC



LITTLE ACRES | 76-21113

Ages: 2-5
Use Zone: 22'x22'
Equipment Size: 9'9"x8'1"x5'7"
Fall Height: 12"

PLAYHOUSE CLASSIC

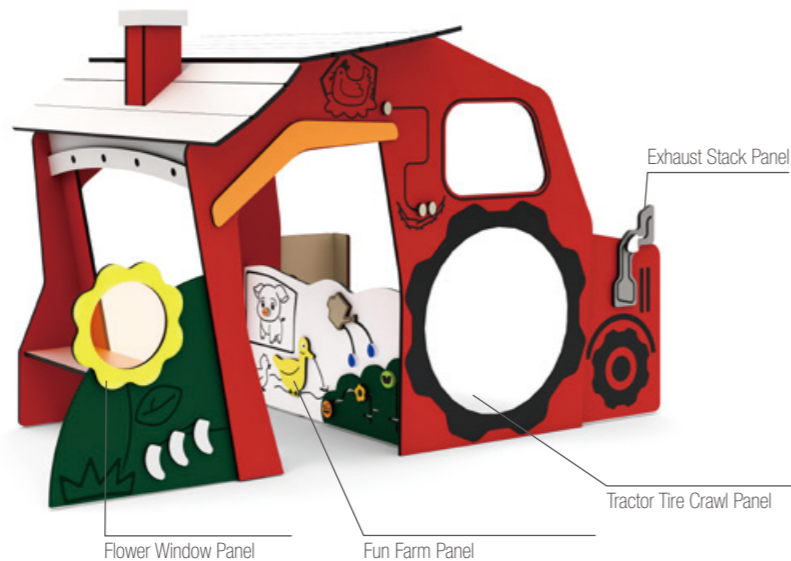

Flower Window Panel

Fun Farm Panel

Tractor Tire Crawl Panel

Exhaust Stack Panel



Funny Tree Panel

Game Table



CAMP BOGGY | 76-21111

Ages: 2-5
Use Zone: 17'x18'
Equipment Size: 4'11"x5'11"x5'11"
Fall Height: 12"

BUNGALOW PLUS



Insects Moving Game

Funny Tree Panel

Game Table

Music Grove Panel



CROAKER CABIN | 76-21114

Ages: 2-5
Use Zone: 22'x17'
Equipment Size: 10'10"x5'10"x7'4"
Fall Height: 24"

BUNGALOW



Funny Tree Panel

Numbers Moving Game



THE LEARNING LODGE | 76-21116

Ages: 2-5
Use Zone: 18'x17'
Equipment Size: 6'x5'10"x6'6"
Fall Height: 24"

BUNGALOW PLUS



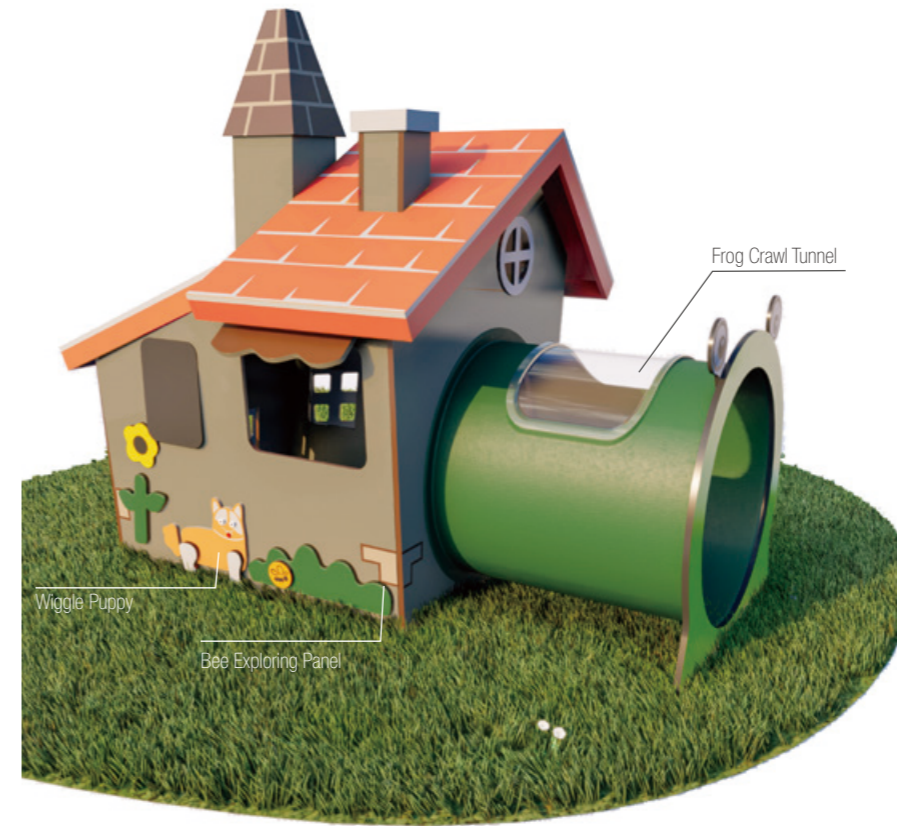

FROGGY HOLLOW | 76-21117

Ages: 2-5

Use Zone: 20'x17'

Equipment Size: 7'2"x4'11"x6'3"

FOREST FLOOR



**TOADSTOOL BURROW
76-21118**

Ages: 2-5

Use Zone: 25'x22'

Equipment Size: 12'6"x9'9"x9'1"

Fall Height: 36"

FOREST FLOOR



**DISCOVERY DEN
76-21115**

Ages: 2-5

Use Zone: 16'x15'

Equipment Size: 4'10"x3'11"x4'

Fall Height: 16"

INVENTORS YARD



WisePLAY

WisePLAY structures by Wisdom are the ultimate solution for organizations seeking vibrant, space-efficient play areas that don't skimp on excitement or durability. Designed with sturdy 3.5" 13-gauge steel posts, these thoughtfully crafted structures combine lightweight versatility with unwavering safety and quality standards.

Each WisePLAY design is packed with engaging activities that spark creativity and active play, making them a favorite for communities and schools alike. Best of all, WisePLAY structures are budget-friendly, offering reduced shipping and purchase costs—delivering exceptional value without compromising on fun, functionality, or durability. Bring endless play to your space with WisePLAY!

- 095 WisePLAY Inclusive
- 105 WisePLAY Custom
- 139 WisePLAY Theme



3.5

WP

www.wisdomplaygrounds.com

WisePLAY Inclusive

All-inclusive playgrounds are accessible, but not all accessible playgrounds are inclusive. At Wisdom Playgrounds we understand that we are not just designing our structures for the children. We know it takes a village to raise a child, which is why we always accommodate the parents and caregivers of various abilities that utilize our equipment. Following some fundamental principals, an inclusive playground will ensure that everyone can access the best play activities on the playground.

A crucial element to making an inclusive playground work for everyone is co-locating various kinds of the same type of activity so that someone who may have physical abilities can enjoy the same activity as the person close to them on a similar but perhaps more challenging activity. At Wisdom, we can all play together.

WisePLAY Inclusive playgrounds are artistically crafted with 3.5" OD galvanized steel support posts which allows the structure to be lighter, and more versatile. Without sacrificing features such as safety or durability, we accommodate getting you a high quality playgrounds packed full of activities.



Scan above to learn more



WisePLAY



Inclusive



ADA



3.5" Post



SAN ANTONIO PDWP-350121C33

Ages: 5-12

Fall Height: 84"

Use Zone: 71'x64'

Equipment Size: 58'5" x 51'6" x 16'9"

NATUREBRITE

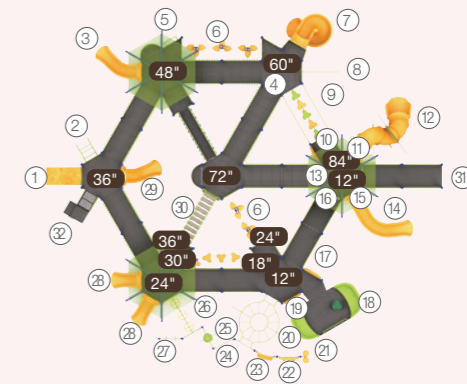

- ① 4ft/5ft Rock Climber
- ② 3ft Arch Climber
- ③ 4ft Sectional Slide 45° Right Turn
- ④ ABC Panel
- ④ 4ft Straight Rung Climber
- ④ 2ft-4ft Spiral Leaf Step Climber
- ⑦ 5ft Spiral Slide
- ⑧ 5ft Stairs Climber
- ⑨ Clover Steps Bridge w/Handrails
- ⑩ Four In A Row Panel
- ⑩ Marimba Panel
- ⑩ 7ft Sectional Slide Left Turn
- ⑪ World Map Panel
- ⑪ 7ft Sectional Slide Right Turn
- ⑫ Bongs & Cups Panel
- ⑫ Maze Panel
- ⑫ Chimes Panel
- ⑬ Bongo
- ⑬ Power Rungs
- ⑭ Puzzle Panel
- ⑭ Round Horizontal Ladder
- ⑭ Straight Horizontal Loop Ladder
- ⑮ Large Square Tic-tac-toe Panel
- ⑮ Counter Panel
- ⑮ Overhead Rotating Rings
- ⑮ Jumbo Round Stepper
- ⑮ 2ft Sectional Slide
- ⑮ 3ft Sectional Slide Left Turn
- ⑮ ADA Ramp
- ⑮ Step Board Bridge w/Handrail
- ⑮ ADA Transfer Station



AMARILLO
PDWP-350125C3A

Ages: 5-12
Fall Height: 84"
Use Zone: 71'x64'
Equipment Size: 58'5" x 51'6" x 18'

COLORBURST

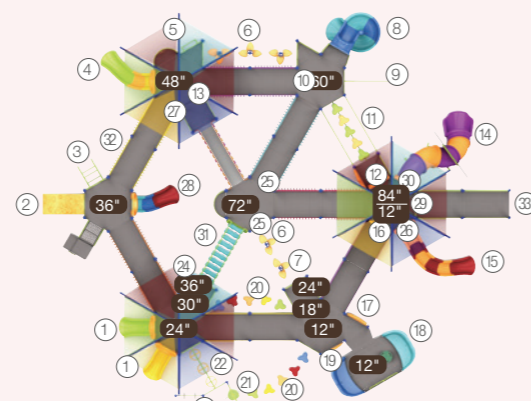
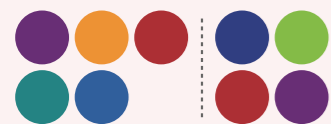

- | | | |
|--|-------------------------------------|---------------------------------|
| ① 2ft Sectional Slide | ② 4ft/5ft Rock Climber | ③ 3ft Arch Climber |
| ④ 4ft Sectional Slide 45° Right Turn | ⑤ 4ft Straight Rung Climber | ⑥ 4ft-6ft Upright Leaf Climber |
| ⑦ 2ft-4ft Upright Leaf Climber | ⑧ 5ft Spiral Slide | ⑨ 5ft Stairs Climber |
| ⑩ ABC Panel | ⑪ Inclined Clover Steps w/Handrail | ⑫ Four In A Row Panel |
| ⑬ Clover Seat - Set of 2 | ⑭ 7ft S-shape Tube Slide Right Turn | ⑮ 7ft Sectional Slide Left Turn |
| ⑯ Maze Panel | ⑰ Beads & Cups Panel | ⑱ Rock & Roll On |
| ⑲ Puzzle Panel | ⑳ Clover Steps | ㉑ Jumbo Round Stepper |
| ㉒ Wheel Rings | ㉓ Straight Horizontal Loop Ladder | ㉔ 3ft Upright PE Rock Climber |
| ㉕ Saddle Seat | ㉖ Chimes Panel | ㉗ 5ft GEO Vertical Climber |
| ㉘ 3ft Sectional Slide Left Turn | ㉙ World Map Panel | ㉚ Marimba Panel |
| ㉛ Inclined Wooden Step Board Bridge w/Handrail | ㉜ Walkway Deck | ㉝ ADA Ramp |

PALM BAY COVE
PDWP-350118C32

Ages: 5-12
Fall Height: 72"
Use Zone: 51'x45'
Equipment Size: 37'6" x 32'5" x 14'6"

SUNDRIFT

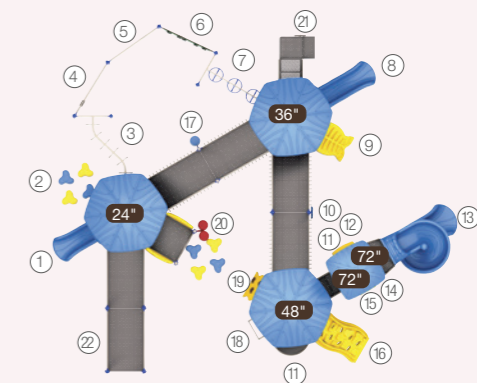

- | | | |
|----------------------------------|-------------------------|---------------------------------|
| ① 2ft Sectional Slide | ② Clover Step | ③ Zig Zag Overhead Rings |
| ④ Net Climber-Leaf | ⑤ Net Climber - Ladder | ⑥ Net Climber - Grass & Ladybug |
| ⑦ Overhead Rotating Rings | ⑧ 3ft Single Slide | ⑨ 2ft/3ft Fish Climber |
| ⑩ Rain Wheel | ⑪ Counter Panel (Below) | ⑫ ABC Panel (Above) |
| ⑬ 6ft Spiral Slide | ⑭ Saddle Seat (Below) | ⑮ Tic-Tac-Toe Panel (Above) |
| ⑯ Double-sided Wave Rock Climber | ⑰ PE Stool | ⑱ 4ft Straight Rung Climber |
| ⑲ 4ft PE Rock Climber | ⑳ Bongo | ㉑ ADA Transfer Station |



CHARLOTTE'S FUN ZONE PDWP-350073C00

Ages: 5-12
Fall Height: 96"
Use Zone: 56'x67'
Equipment Size: 43'6"x54'3"x15'9"

EMBER

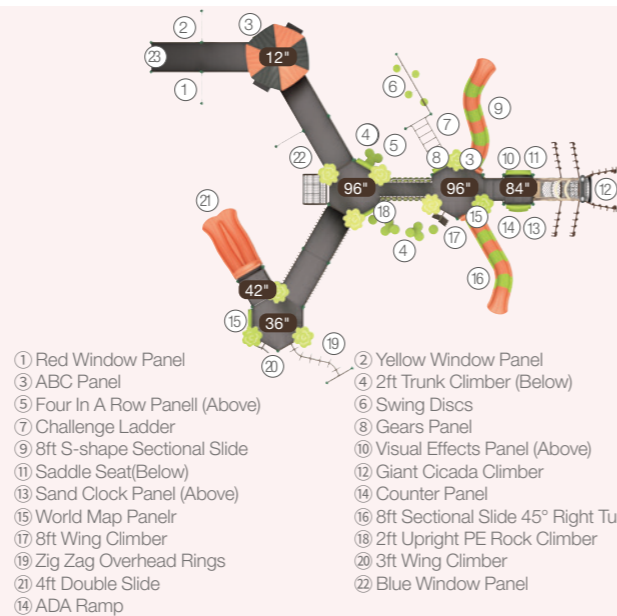

FORKS PARK PDWP-350115C32

Ages: 5-12
Fall Height: 84"
Use Zone: 80'x54'
Equipment Size: 65'2"x39'4"x14'9"

FLANNEL

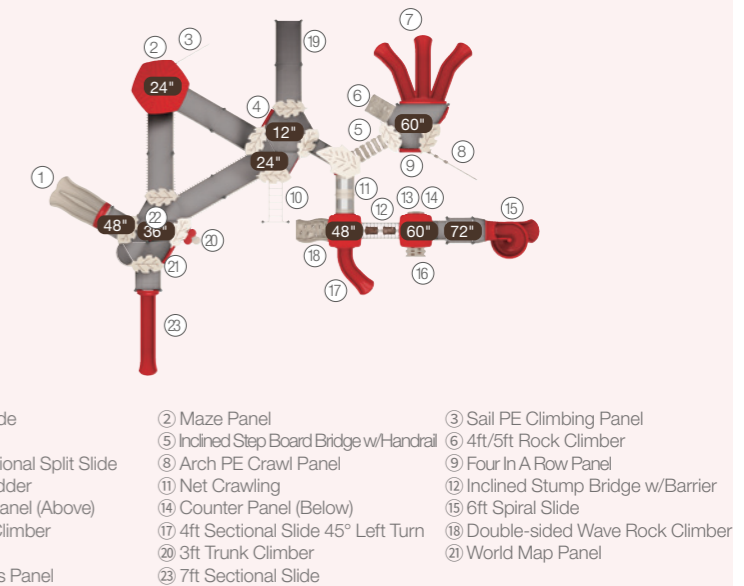



ISLAND WONDER PDWP-350075C33

Ages: 5-12
Fall Height: 84"
Use Zone: 93'x38'
Equipment Size: 79'3"x25'10"x13'9"

DEEP SEA

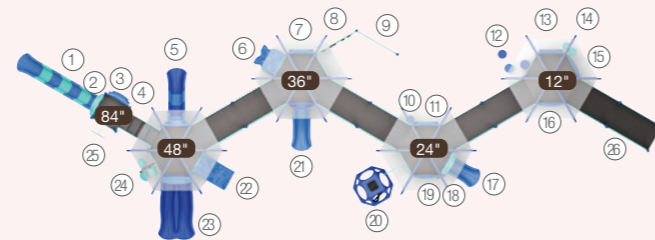

- | | |
|-------------------------------|-------------------------------|
| ① 7ft Sectional Slide | ② Saddle Seat |
| ③ Four In A Row Panel (Above) | ④ Counter Panel (Below) |
| ⑤ 4ft Sectional Slide | ⑥ 2ft/3ft Fish Climber |
| ⑦ Gears Panel | ⑧ Net Climber-Grass & Ladybug |
| ⑨ Net Climber-Ladder | ⑩ PE Stool |
| ⑪ ABC Panel | ⑫ 12" Single Trunk Climber |
| ⑬ World Map Panel | ⑭ Bongo |
| ⑮ Beads & Cups Panel | ⑯ Maze Panel |
| ⑰ 2ft Sectional Slide | ⑱ Rain Wheel |
| ⑲ Puzzle Panel | ⑳ Qubest |
| ㉑ 3ft Single Slide | ㉒ 4ft/5ft Rock Climber |
| ㉓ 4ft Double Slide | ㉔ 4ft Leaf Step Climber |
| ㉕ 7ft Snake Climber | ㉖ ADA Ramp |

NEW



SHIFTING SANDS PDWP-350126C32

Ages: 2-5 & 5-12
Fall Height: 96"
Use Zone: 97'x85'
Equipment Size: 81'5"x68'6"x16'7"

PHARO

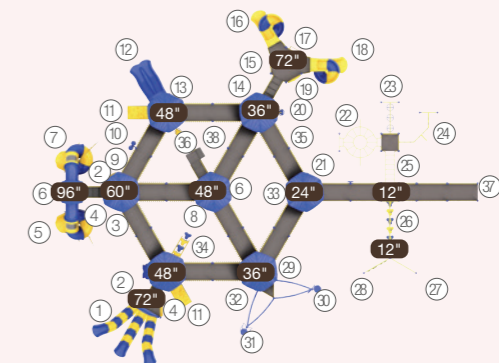

- | | | |
|------------------------------------|-----------------------------------|----------------------------------|
| ① 6ft Triple Sectional Split Slide | ② Counter Panel | ③ Beads & Cups Panel |
| ④ Saddle Seat | ⑤ 8ft Spiral Tube Slide Left Turn | ④ Window Panel |
| ⑦ 8ft Spiral Tube Slide Right Turn | ⑧ 4ft Straight Rung Climber | ⑨ Large Square Tic-tac-toe Panel |
| ⑩ Bongo | ⑪ 4ft/8ft Rock Climber | ⑫ 4ft Double Slide |
| ⑬ Treasure Hunt Panel | ⑭ World Map Panel | ⑮ 6ft Vertical Climber |
| ⑯ 6ft Spiral Slide Left Turn | ⑰ 6ft Straight Rung Climber | ⑱ 6ft Spiral Slide Right Turn |
| ⑲ Puzzle Panel | ⑳ 3ft Pod Climber | ㉑ Four In A Row Panel |
| ㉒ Round Horizontal Ladder | ㉓ Overhead Rotating Rings | ㉔ 90° Overhead Swinging Rings |
| ㉕ Challenge Ladder | ㉖ 5 Clover Steps Bridge | ㉗ Net Climber - Ladder |
| ㉘ Net Climber - Grass & Ladybug | ㉙ Beads & Cups Panel | ㉚ Standing Corkscrew Spinner |
| ㉛ ABC Panel | ㉜ Rain Wheel | ㉝ Gears Panel |
| ㉞ 4ft Clover Steps | ㉟ ADA Transfer Station | ㊱ 4ft Pod Climber |
| ㊲ ADA Ramp | | |

NEW

Rock and Roll ON



WISE TRAVELER PDWP-350072C33

Ages: 2-5 & 5-12

Fall Height: 48"

Use Zone: 40'x47'

Equipment Size: 26'10"x34'1"x10'10"

WILDWOOD

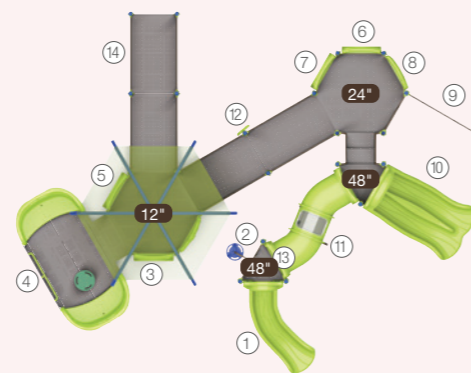

- ① 4ft Sectional Slide 45° Left Turn
- ② 4ft Pod Climber
- ③ ABC Panel
- ④ Rock and Roll ON
- ⑤ World Map Panel
- ⑥ Four In A Row Panel
- ⑦ Window Panel
- ⑧ Beads & Cups Panel
- ⑨ Rung Challenge Climber
- ⑩ 4ft Double Slide
- ⑪ S-shape Crawl Tunnel
- ⑫ Rain Wheel
- ⑬ Saddle Seat
- ⑭ ADA Ramp

TIGER LILY PDWP-350127C33

Ages: 2-5 & 5-12

Fall Height: 48"

Use Zone: 58'x48'

Equipment Size: 51'5"x35'4"x19'3"

EMPRESS

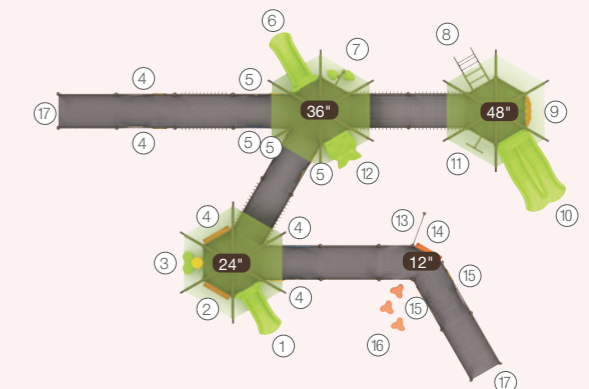

- ① 2ft Single Slide
- ② World Map Panel
- ③ 2ft Trunk Climber
- ④ ABC Panel
- ⑤ Treasure Hunt Panel
- ⑥ 3ft Single Slide
- ⑦ 3ft Leaf Step Climber
- ⑧ 4ft Arch Climber
- ⑨ Large Square Tic-tac-toe Panel
- ⑩ 4ft Double Slide
- ⑪ 4ft Snake Climber
- ⑫ 2ft/3ft Fish Climber
- ⑬ Single Bar
- ⑭ Four In A Row Panel
- ⑮ ADA Ramp
- ⑯ Gears Panel
- ⑰ 12" Clover Step

WisePLAY Custom

WisePLAY Custom playgrounds provide a versatile and space-efficient solution for organizations seeking a high-quality play environment with a slightly smaller footprint than traditional structures. Designed to meet the unique needs of parks, schools, municipalities, and other recreational facilities, WisePLAY Custom structures offer the added benefit of full customization, allowing clients to tailor their playgrounds to fit specific site dimensions, design preferences, and play requirements.

Each custom structure is engineered with precision and durability in mind, utilizing 3.5" steel posts in place of standard 5" posts. This strategic design choice results in a lighter, more adaptable framework without compromising the structural integrity, safety, or longevity of the equipment. The reduced overall weight of these structures not only simplifies installation but also contributes to cost efficiency in both purchasing and freight logistics.



Scan above to learn more



WisePLAY



Custom



ADA



3.5" Post



NEW



IRONRIDGE PDWP-350128C32

Ages: 5-12

Fall Height: 144"

Use Zone: 87'x77'

Equipment Size: 72'4"x58'8"x21'1"

SIGNAL AND STONE

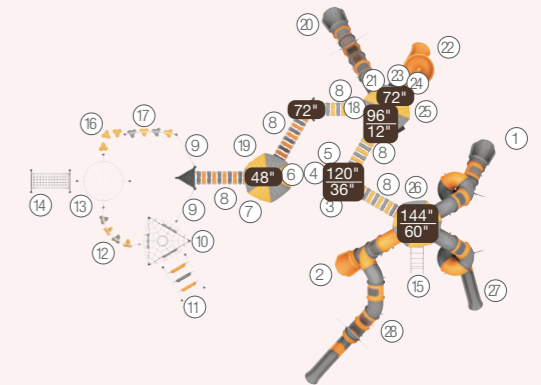

- ① 12ft Spiral Tube Slide Right Turn
- ② 5ft Straight Tube Slide
- ③ 3ft Straight Rung Climber
- ④ Bubble Window Panel (Above)
- ⑤ Puzzle Panel (Below)
- ⑥ Gears Panel
- ⑦ Tic-tac-toe Panel
- ⑧ Step Board Bridge w/Net Barrier
- ⑨ Ladybug Ladder Climber
- ⑩ Triangle Net Climber
- ⑪ Horizontal O-zone Climber
- ⑫ Clover Steps & Balls Bridge 96"
- ⑬ Round Net Climber
- ⑭ V-shape Belt Bridge
- ⑮ 5ft Arch Climber
- ⑯ Clover Seat
- ⑰ 4 Clover Steps Bridge
- ⑱ Maze Panel
- ⑲ World Map Panel
- ⑳ 8ft Straight Tube Slide
- ㉑ Four In A Row Panel
- ㉒ 6ft Spiral Slide
- ㉓ ABC Panel
- ㉔ 2ft Upright PE Rock Climber
- ㉕ Beads & Cups Panel
- ㉖ 5ft PE Vertical Climber w/Fixing Holes
- ㉗ 12ft Spiral Tube Slide Left Turn w/ Open Exit Chute
- ㉘ 12ft S-shape Tube Slide Left Turn w/Open Exit Chute

NEW



SWALE PDWP-350140C3A

Ages: 5-12
Fall Height: 60"
Use Zone: 27'x43'
Equipment Size: 17'1"x30'x16'

LUNAR LIGHT

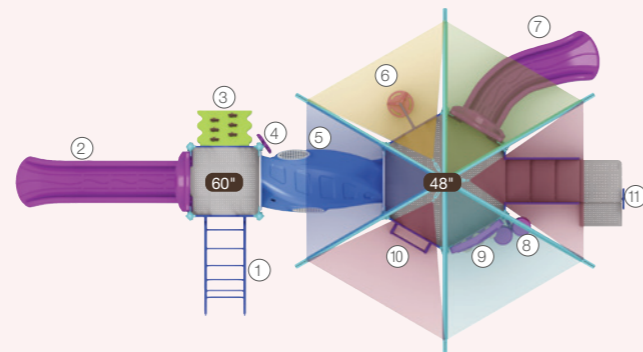

- ① 5ft Arch Climber
- ② 5ft Single Slide
- ③ 5ft Step and Stone Climber
- ④ Rain Wheel
- ⑤ 12" Inclined Twist Challenge Crawl Tunnel
- ⑥ 4ft Pod Climber
- ⑦ 4ft Sectional Slide 45° Right Turn
- ⑧ Bongo
- ⑨ Tic-Tac-Toe Panel
- ⑩ 4ft Ribbon Climber
- ⑪ ADA Transfer Station



CALDER PDWP-350141C00

Ages: 2-5
Fall Height: 36" Use Zone: 30'x32'
Equipment Size: 18'2"x19'6"x13'4"

NATUREBRITE

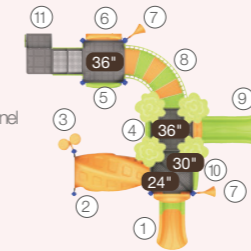

- ① 2ft Single Slide
- ② 24" Inclined Twist Challenge Crawl Tunnel
- ③ Bongo
- ④ Puzzle Panel
- ⑤ Maze Panel
- ⑥ Gears Panel
- ⑦ Talk Tube
- ⑧ 90° Cloud Plank
- ⑨ 3ft Single Slide
- ⑩ Beads & Cups Panel
- ⑪ ADA Transfer Station

CHRONOS PDWP-350139C00

Ages: 5-12
Fall Height: 72" Use Zone: 41'x34'
Equipment Size: 27'5"x20'11"x10'8"

WISP

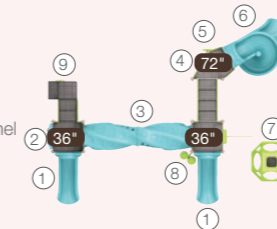

- ① 3ft Single Slide
- ② Tic-Tac-Toe Panel
- ③ Duo Twist Challenge Crawl Tunnel
- ④ 6ft GEO Vertical Climber
- ⑤ Rain Wheel
- ⑥ 6ft Spiral Slide
- ⑦ Qubest
- ⑧ Bongo
- ⑨ ADA Transfer Station



SILAS PDWP-350142C13

Ages: 5-12
Fall Height: 72" Use Zone: 42'x37'
Equipment Size: 29'11"x24'4"x16'2"

SERENE SKY

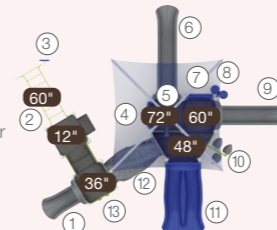

- ① 3ft Single Slide
- ② Deck to ground Challenge Ladder
- ③ Rain Wheel
- ④ Beads & Cups Panel
- ⑤ Counter Panel
- ⑥ 6ft Single Slide
- ⑦ Gears Panel
- ⑧ Bongo
- ⑨ 5ft Single Slide
- ⑩ 4ft Leaf Step
- ⑪ 4ft Double Slide
- ⑫ 24" Inclined Twist Challenge Crawl Tunnel
- ⑬ 3ft Rockwall





SUNDAZED PDWP-350030C00

Ages: 5-12
Fall Height: 96"
Use Zone: 44'x51'
Equipment Size: 27'2"x36'8"x14'10"

SPRING

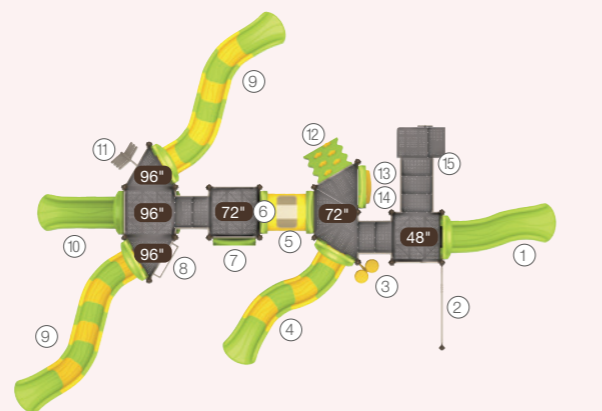

- ① 4ft Single Slide
- ② Net Climber-Ladder
- ③ Bongo
- ④ 6ft S Shape Sectional Slide
- ⑤ 31" Crawl Tunnel
- ⑥ Beads & Cups Panel (Below)
- ⑦ World Map Panel
- ⑧ 8ft Straight Rung Climber
- ⑨ 8ft S Shape Sectional Slide
- ⑩ 3ft Single Slide
- ⑪ 8ft Wing Climber
- ⑫ 6ft PE Rock Climber
- ⑬ Gears Panel (Above)
- ⑭ Counter Panel (Below)
- ⑮ ADA Transfer Station



PINNWHEEL PARADE PDWP-350031C32

Ages: 5-12
Fall Height: 84"
Use Zone: 45'x42'
Equipment Size: 32'9"x29'2"x14'5"

LIMELIGHT

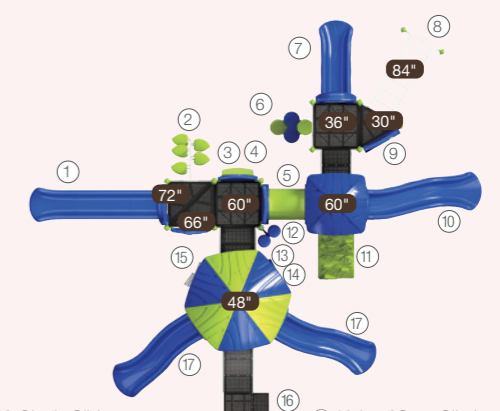

- ① 6ft Single Slide
- ② 6ft Leaf Step Climber
- ③ Counter Panel (Below)
- ④ Maze Panel (Above)
- ⑤ 31" Crawl Tunnel
- ⑥ 3ft Trunk Climber
- ⑦ 3ft Single Slide
- ⑧ Challenge Ladder
- ⑨ World Map Panel
- ⑩ 5ft Single Slide
- ⑪ 4ft/5ft Rock Climber
- ⑫ Bongo
- ⑬ Gears Panel (Above)
- ⑭ Saddle Seat (Below)
- ⑮ 4ft Wing Climber
- ⑯ ADA Transfer Station
- ⑰ 4ft Single Slide



PARADISE PDWP-350032C32

Ages: 5-12
Fall Height: 84"
Use Zone: 34'x46'
Equipment Size: 21'6"x33'4"x13'9"

WHIMSICAL

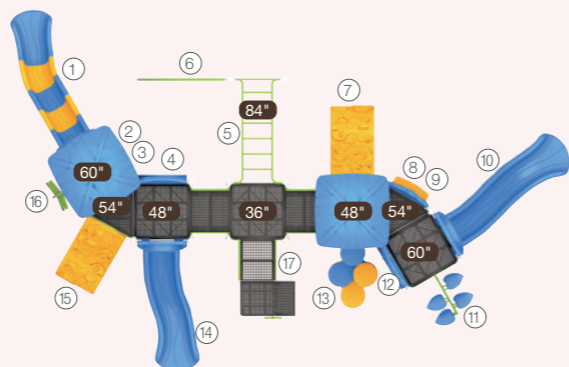

- ① 5ft Sectional Slide Left Turn
- ② Beads & Cups Panel (Above)
- ③ Saddle Seat (Below)
- ④ Four In A Row Panel
- ⑤ Challenge Ladder
- ⑥ Sail PE Climbing Panel
- ⑦ 4ft/5ft Rock Climber
- ⑧ Safety Panel (Above)
- ⑨ Counter Panel (Below)
- ⑩ 5ft Single Slide
- ⑪ 5ft Leaf Step Climber
- ⑫ Gears Panel
- ⑬ 4ft Trunk Climber
- ⑭ 4ft Single Slide
- ⑮ 4ft/5ft Rock Climber
- ⑯ 5ft Wing Climber
- ⑰ ADA Transfer Station



MOONDROP PDWP-350029C32

Ages: 5-12
Fall Height: 72"
Use Zone: 53'x50'
Equipment Size: 39'10"x36'4"x15'

SERENE SKY

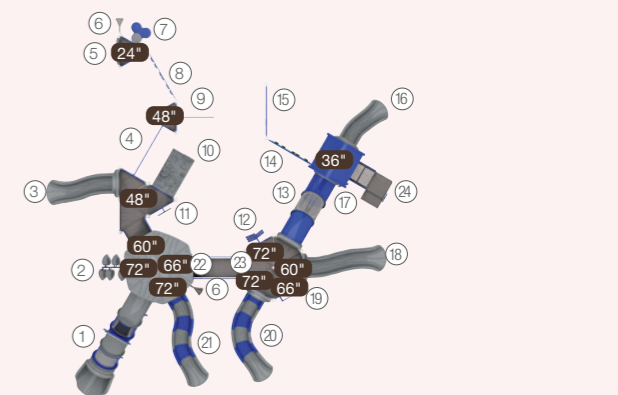

- ① 6ft Straight Tube Slide
- ② 6ft Leaf Step Climber
- ③ 4ft Single Slide
- ④ Arch Link
- ⑤ Beads & Cups Panel
- ⑥ Talk Tube
- ⑦ 2ft Trunk Climber
- ⑧ Arch PE Rock Climber Link
- ⑨ 4ft Stairs Climber
- ⑩ 4ft/5ft Rock Climber
- ⑪ 4ft Snake Climber
- ⑫ 6ft Wing Climber
- ⑬ S-shape Crawl Tunnel
- ⑭ Net Climber - Grass & Ladybug
- ⑮ Net Climber - Ladder
- ⑯ 5ft Single Slide
- ⑰ Rain Wheel
- ⑱ 6ft Straight Rung Climber
- ⑲ 6ft Sectional Slide 67.5° Left Turn
- ⑳ 6ft S-shape Sectional Slide
- ㉑ ABC Panel
- ㉒ Counter Panel
- ㉓ ADA Transfer Station





**GOLDSTAR
PDWP-350034C00**

Ages: 5-12
Fall Height: 96"
Use Zone: 38'x33'
Equipment Size: 23'7"x19'x12'7"

POWER

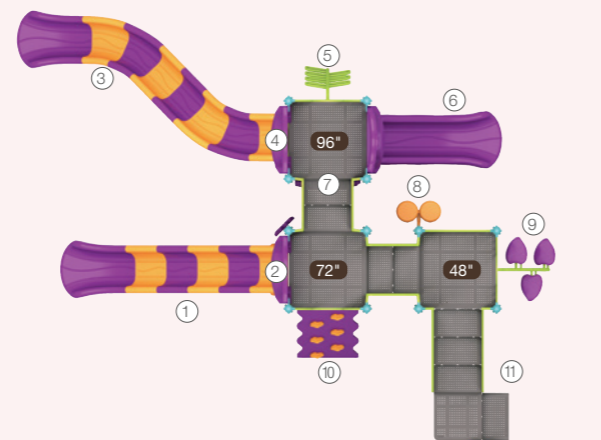

- ① 6ft Sectional Slide
- ② Counter Panel (Below)
- ③ 8ft S Shape Sectional Slide
- ④ 3ft PE Rock Climber (Below)
- ⑤ 8ft Wing Climber
- ⑥ 3ft Single Slide
- ⑦ Maze Panel (Below)
- ⑧ Bongo
- ⑨ 4ft Leaf Step Climber
- ⑩ 6ft PE Rock Climber
- ⑪ ADA Transfer Station



**DOODLEBUG
PDWP-350129C32**

Ages: 5-12
Fall Height: 108"
Use Zone: 62'x42'
Equipment Size: 49'8"x29'3"x15'2"

LIVELY

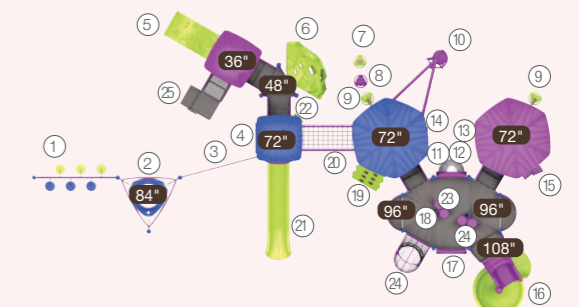

- ① Toadstool Climber
- ② O-zone Climber
- ③ Net Climber
- ④ Gears Panel
- ⑤ 4ft/8ft Rock Climber
- ⑥ Hemisphere Climber
- ⑦ 4ft Pod Climber
- ⑧ 5ft Pod Climber
- ⑨ 6ft Pod Climber
- ⑩ Standing Orbital Spinner
- ⑪ Bubble Window Panel
- ⑫ Visual Effects Panel
- ⑬ 6ft Upright PE Rock Climber
- ⑭ 6ft Straight Rung Climber
- ⑮ 9ft Spiral Slide
- ⑯ World Map Panel
- ⑰ Bongo
- ⑱ 6ft PE Rock Climber
- ⑲ Trunk Link w/Metal Barrier
- ⑳ 6ft Sectional Slide
- ㉑ Rain Wheel
- ㉒ Jungle Adventure Panel
- ㉓ Upright Climbing Rope Tunnel Height : 9ft
- ㉔ ADA Transfer Station



NEW



SNAPDRAGON
PDWP-350130C11

Ages: 5-12
Fall Height: 84"
Use Zone: 41'x44'
Equipment Size: 28'10"x31'5"x12'11"

NATUREBRITE

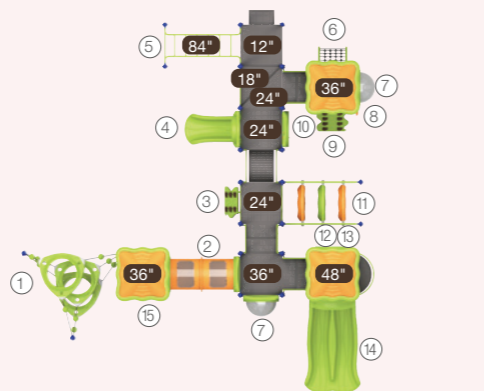

- ① Vertical O-zone Climber
- ② Net Crawling
- ③ 2ft PE Wave Rock Climber
- ④ 2ft Sectional Slide
- ⑤ Challenge Ladder
- ⑥ 3ft Net Climber
- ⑦ Bubble Window Panel
- ⑧ Rain Wheel
- ⑨ 3ft PE Wave Rock Climber
- ⑩ Gears Panel
- ⑪ O-zone Climber
- ⑫ Saddle Seat (Below)
- ⑬ Four In A Row Panel (Above)
- ⑭ 4ft Double Slide
- ⑮ Marimba Panel

NEW



JINXBERRY
PDWP-350131C00

Ages: 5-12
Fall Height: 84"
Use Zone: 45'x37'
Equipment Size: 33'4"x23'2"x10'11"

BRAMBLE

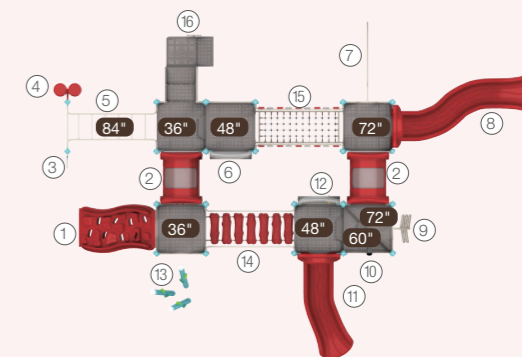

- ① Double-sided Wave Rock Climber
- ② 31" Crawl Tunnel
- ③ PE Height Measurer Panel
- ④ Bongo
- ⑤ Challenge Ladder
- ⑥ Four In A Row Panel
- ⑦ 6ft Climbing Arc
- ⑧ 6ft S-shape Sectional Slide
- ⑨ 6ft Wing Climber
- ⑩ V
- ⑪ 4ft Sectional Slide 22.5° Left Turn
- ⑫ Gears Panel
- ⑬ Through the Jungle-Single
- ⑭ Inclined Step Board Bridge w/Barrier
- ⑮ Arch Net Bridge w/Brown & Tan Wood Grain Barrier
- ⑯ ADA Transfer Station

NEW



GALAXY GIGGLE PDWP-350132C13

Ages: 5-12
Fall Height: 72"
Use Zone: 54'x60'
Equipment Size: 32'9"x38'8"x16'2"

MIDNIGHT STEEL

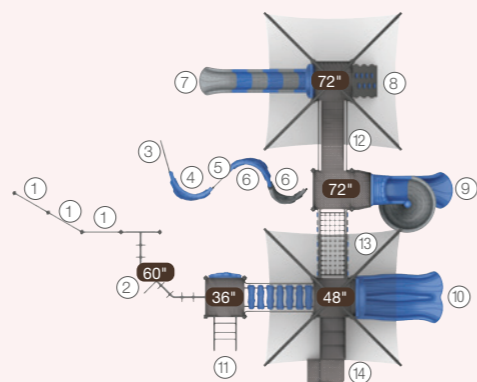

- ① Single Bar
- ② 90° Overhead Swinging Rings
- ③ Moab Rock Climber Arch Side Frame - L
- ④ Moab Rock Climber - S
- ⑤ Moab Rock Climber Inter Rung Ladder
- ⑥ Moab Rock Climber - L
- ⑦ 6ft Sectional Slide
- ⑧ 6ft PE Rock Climber
- ⑨ 6ft Spiral Slide
- ⑩ 4ft Double Slide
- ⑪ 3ft Arch Climber
- ⑫ Inclined Step Board Bridge w/Barrier
- ⑬ Arch Net Bridge w/Brown & Tan Wood Grain Barrier
- ⑭ ADA Transfer Station



NEW



LUMIN PDWP-350133C33

Ages: 5-12
Fall Height: 84"
Use Zone: 56'x45'
Equipment Size: 43'2"x31'9"x14'8"

NATUREBRITE

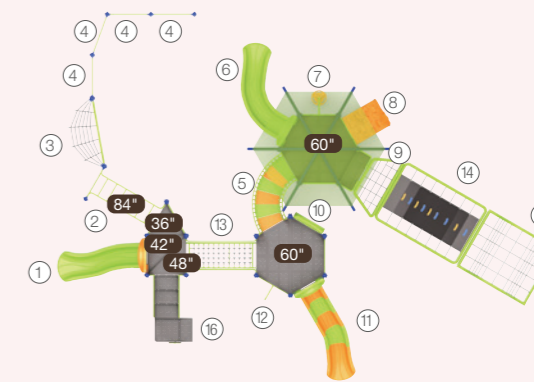

- ① 4ft Single Slide
- ② Challenge Ladder
- ③ Inclined Net Climber
- ④ Horizontal Bar
- ⑤ 90 Degree Bridge w/Barrier
- ⑥ 5ft Sectional Slide 67.5° Right Turn
- ⑦ 5ft Pod Climber
- ⑧ 4ft/5ft Rock Climber
- ⑨ Trapezoid Net Climber 3ft
- ⑩ ABC Panel
- ⑪ 5ft Sectional Slide 22.5° Right Turn
- ⑫ 5ft Fireman's Pole
- ⑬ Inclined Arch Net Bridge w/Handrail
- ⑭ Rectangular Belt Walking 3ft
- ⑮ Wave Net Climber 6ft
- ⑯ ADA Transfer Station



NEW



NIMBLENOOK PDWP-350134C00

Ages: 5-12
Fall Height: 84"
Use Zone: 41'x37'
Equipment Size: 29'2"x24'1"x9'11"

MYSTERY

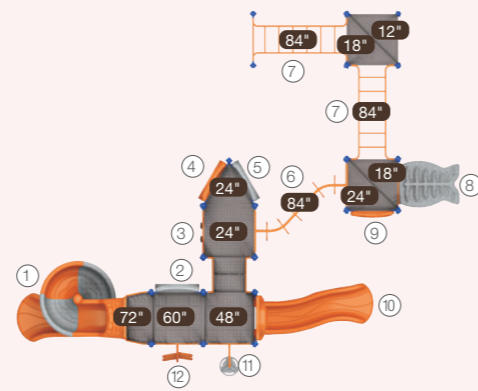

- ① 6ft Spiral Slide
- ② 2ft Rockwall
- ③ 2ft ABC Panel
- ④ Challenge Ladder
- ⑤ Maze Panel
- ⑥ 4ft Pod Climber
- ⑦ Four In A Row Panel
- ⑧ World Map Panel
- ⑨ Zig Zag Overhead Rings
- ⑩ 2ft/3ft Fish Climber
- ⑪ 5ft Wing Climber
- ⑫ 4ft Single Slide

TWISTER PDWP-350077C15

Ages: 5-12
Fall Height: 108"
Use Zone: 40'x34'
Equipment Size: 27'3"x22'x14'9"

FLANNEL

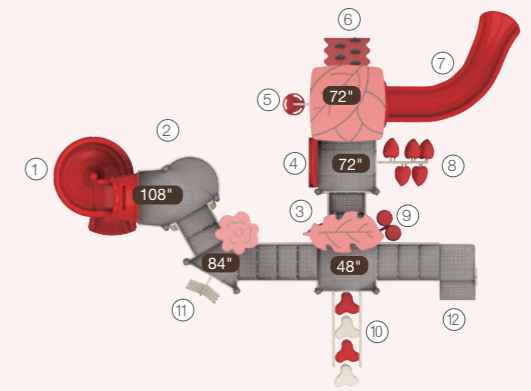

- ① 9ft Spiral Slide
- ② Saddle Seat
- ③ Rain Wheel
- ④ ABC Panel
- ⑤ 6ft Pod Climber
- ⑥ 6ft PE Rock Climber
- ⑦ 6ft Sectional Slide 67.5° Left Turn
- ⑧ 6ft Leaf Step Climber
- ⑨ Bongo
- ⑩ 4ft Clover Steps
- ⑪ 7ft Wing Climber
- ⑫ ADA Transfer Station



JUNGLETEM PDWP-350082C32

Ages: 5-12
Fall Height: 96"
Use Zone: 43'x36'
Equipment Size: 28'10"x24'x17'1"

HARVEST

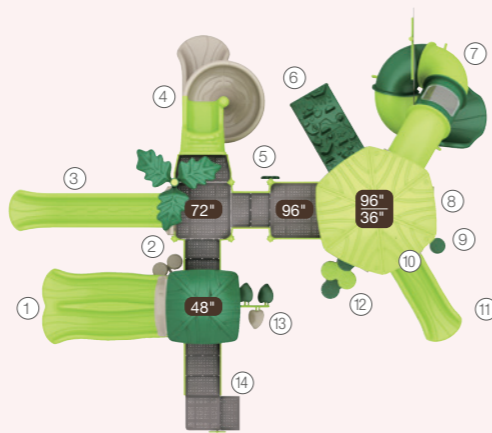

- ① 4ft Double Slide
- ② Bongo
- ③ 6ft Sectional Slide
- ④ 4ft Spiral Slide
- ⑤ Rain Wheel
- ⑥ 4ft/5ft Rock Climber
- ⑦ 8ft Spiral Tube Slide Right Turn
- ⑧ ABC Panel
- ⑨ PE Stool
- ⑩ Beads & Cups Panel (Above)
- ⑪ 3ft Single Slide
- ⑫ 3ft Trunk Climber
- ⑬ 4ft Leaf Step Climber
- ⑭ ADA Transfer Station



ROVER RIDER | PDWP-350083C00

Ages: 5-12
Fall Height: 72"
Use Zone: 41'x38'
Equipment Size: 28'3"x25'8"x10'

PRISMATIC

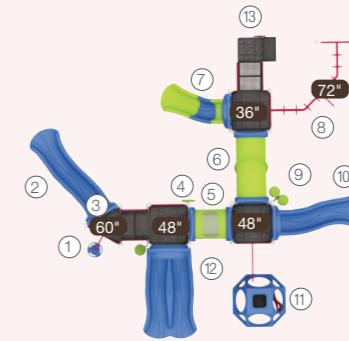

- ① 5ft Pod Climber
- ② 5ft Single Slide
- ③ Counter Panel (Below)
- ④ Rain Wheel
- ⑤ Crawl Tunnel
- ⑥ Inclined Crawl Tunnel
- ⑦ 3ft Sectional Slide Right Turn
- ⑧ 90° Overhead Swinging Rings
- ⑨ Bongo
- ⑩ 4ft Single Slide
- ⑪ Qubest
- ⑫ 4ft Double Slide
- ⑬ ADA Transfer Station

THICKET PDWP-350135C12

Ages: 5-12
Fall Height: 60"
Use Zone: 40'x44'
Equipment Size: 27'10"x31'5"x13'9"

POWER

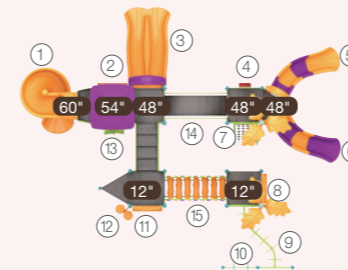

- ① 5ft Spiral Slide
- ② Gears Panel
- ③ 4ft Double Slide
- ④ Counter Panel
- ⑤ 4ft Sectional Slide 45° Right Turn
- ⑥ 4ft Sectional Slide 45° Left Turn
- ⑦ 4ft Net Climber
- ⑧ ABC Panel
- ⑨ Zig Zag Overhead Rings
- ⑩ Straight Horizontal Loop Ladder
- ⑪ Four In A Row Panel
- ⑫ Bongo
- ⑬ 5ft Wing Climber
- ⑭ Arch Bridge w/o Handrails
- ⑮ Step Board Bridge w/Wood Grain Barrier



NEW



NEW



BRISK SEABREEZE PDWP-350085C32

Ages: 5-12
Fall Height: 72"
Use Zone: 36'x34'
Equipment Size: 24'x21'6"x15'1"

SHORELINE

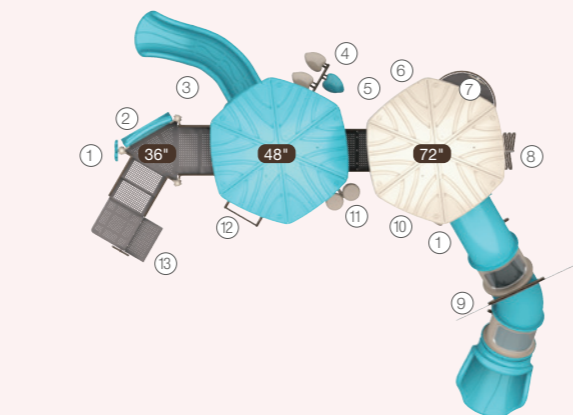

- ① Rain Wheel
- ② World Map Panel
- ③ 4ft Sectional Slide 45° Left Turn
- ④ 4ft Leaf Step Climber
- ⑤ Maze Panel (Above)
- ⑥ Saddle Seat (Below)
- ⑦ Balcony Deck
- ⑧ 6ft Wing Climber
- ⑨ 6ft L-shape Tube Slide Right Turn
- ⑩ Puzzle Panel
- ⑪ Bongo
- ⑫ 4ft Straight Rung Climber
- ⑬ ADA Transfer Station

FOUNDRY PDWP-350136C00

Ages: 5-12
Fall Height: 84"
Use Zone: 45'x39'
Equipment Size: 30'8"x26'8"x12'

FLANNEL

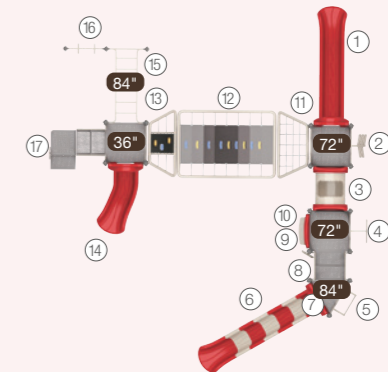

- ① 6ft Sectional Slide
- ② 6ft Wing Climber
- ③ Crawl Tunnel
- ④ 6ft Snake Climber
- ⑤ 7ft Straight Rung Climber
- ⑥ 7ft Sectional Slide
- ⑦ Gears Panel
- ⑧ Rain Wheel
- ⑨ Maze Panel (Above)
- ⑩ Counter Panel (Below)
- ⑪ Trapezoid Net Climber 3ft
- ⑫ Rectangular Belt Walking 3ft
- ⑬ Trapezoid Belt Climber 3ft
- ⑭ 3ft Sectional Slide Right Turn
- ⑮ Challenge Ladder
- ⑯ ADA Transfer Station



TERRYS MAZE
PDWP-350089C13

Ages: 5-12
Fall Height: 84"
Use Zone: 41'x40'
Equipment Size: 28'9"x26'1"x17'2"

NATUREBRITE

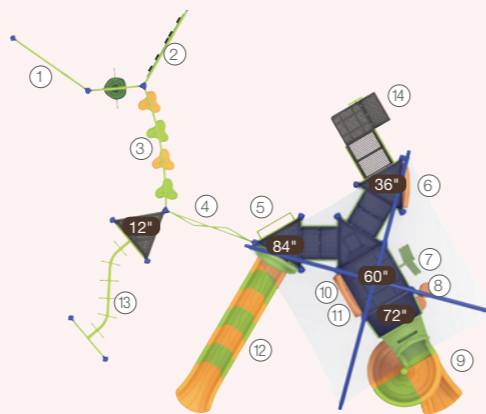

- ① Ladybug Ladder Climber
- ② Net Climber-Grass & Ladybug
- ③ 4 Clover Steps Bridge
- ④ S Balance Bridge
- ⑤ 7ft Straight Rung Climber
- ⑥ Puzzle Panel
- ⑦ 6ft Wing Climber
- ⑧ Bongo
- ⑨ 6ft Spiral Slide
- ⑩ Gears Panel (Above)
- ⑪ Saddle Seat (Below)
- ⑫ 7ft Sectional Slide
- ⑬ Zig Zag Overhead Rings
- ⑭ ADA Transfer Station



LIGHTHOUSE
PDWP-350091C32

Ages: 5-12
Fall Height: 96"
Use Zone: 39'x37'
Equipment Size: 24'11"x22'7"x17'2"

HELPFUL

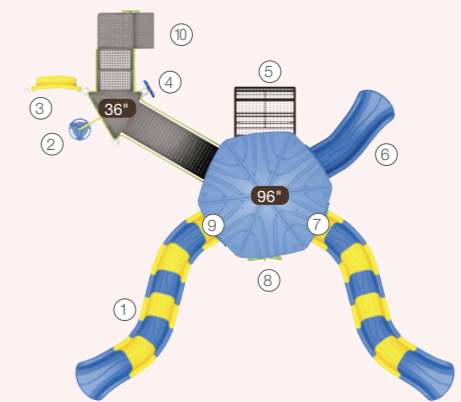

- ① 8ft S-shape Sectional Slide
- ② 3ft Pod Climber
- ③ Counter Panel
- ④ Rain Wheel
- ⑤ Arch Climbing Structure Bay Window
- ⑥ 3ft Sectional Slide Left Turn
- ⑦ World Map Panel
- ⑧ 3ft Wing Climber
- ⑨ ABC Panel (Below)
- ⑩ ADA Transfer Station



NEW



WAYWELL PDWPPE-350023C

Ages: 5-12
Fall Height: 144"
Use Zone: 71'x70'
Equipment Size: 55'1"x55'8"x20'11"

FINN

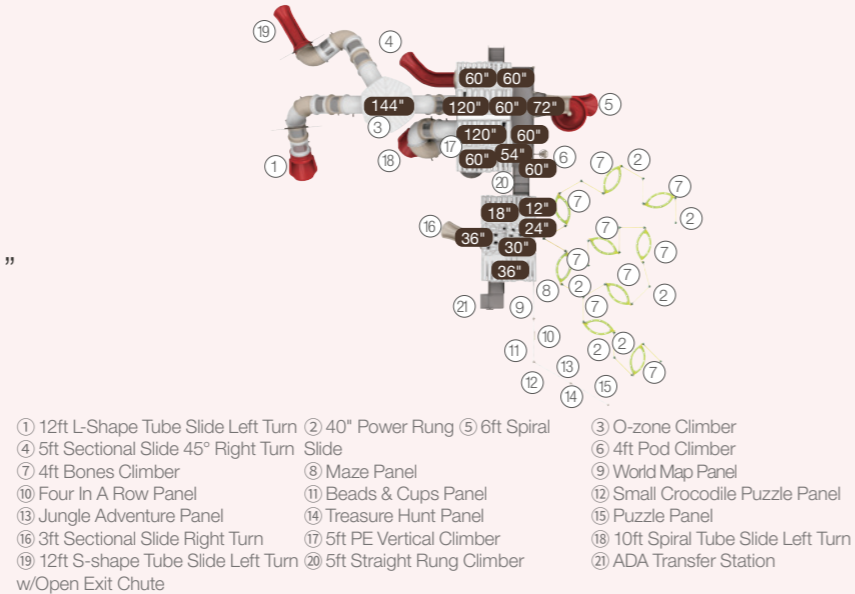

GLENROCK HEIGHTS PDWP-350109C32

Ages: 5-12
Fall Height: 120"
Use Zone: 57'x45'
Equipment Size: 44'3"x34'5"x18'11"

SERENE SKY

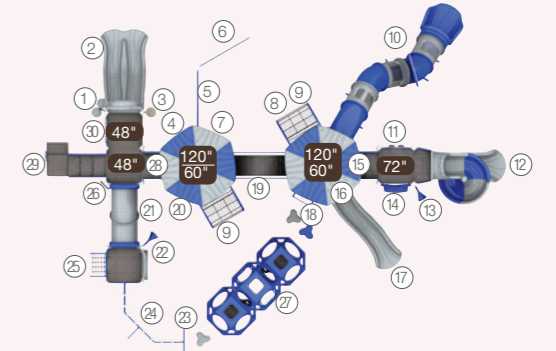

- ① Bongo
- ② 4ft Double Slide
- ③ PE Stool
- ④ Maze Panel
- ⑤ Honeycomb Net Climber
- ⑥ Vertical Net Link
- ⑦ Puzzle Panel
- ⑧ Saddle Seat (Below)
- ⑨ Arch Climbing Structure Bay Window
- ⑩ 10ft S-shape Tube Slide Right Turn
- ⑪ 6ft Upright PE Rock Climber
- ⑫ 6ft Spiral Slide
- ⑬ Talk Tube
- ⑭ Counter Panel
- ⑮ Four In A Row Panel
- ⑯ Beads & Cups Panel
- ⑰ 5ft Single Slide
- ⑱ Arch Bridge w/o Handrails
- ⑲ 5ft GEO Vertical Climber
- ⑳ 6" Clover Step
- ㉑ 90° Overhead Swinging Rings
- ㉒ World Map Panel
- ㉓ Rain Wheel
- ㉔ Qubes
- ㉕ 3ft Net Climber
- ㉖ ADA Transfer Station
- ㉗ Marimba Panel
- ㉘ Gears Panel



LINDEN LOOP PDWP-350124CC

Ages: 2-5
Fall Height: 48"
Use Zone: 36'x25'
Equipment Size: 21'x11'10"x13'6"

EMERALD NIGHT

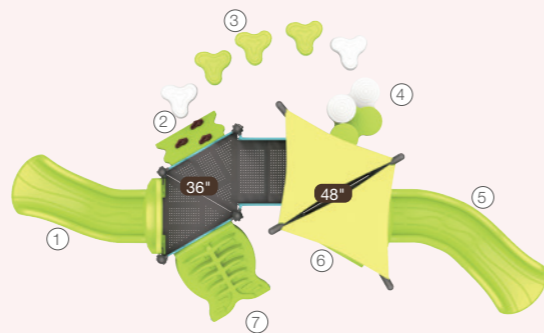

- ① 3ft Sectional Slide Right Turn
- ② 3ft PE Rock Climber
- ③ Clover Step
- ④ 4ft Trunk Climber
- ⑤ 4ft Sectional Slide 45° Right Turn
- ⑥ Window Panel
- ⑦ 2ft/3ft Fish Climber



AMBERLEY PDWP-350092C00

Ages: 2-5 & 5-12
Fall Height: 60"
Use Zone: 38'x37'
Equipment Size: 25'7"x24'9"x10'

POWER

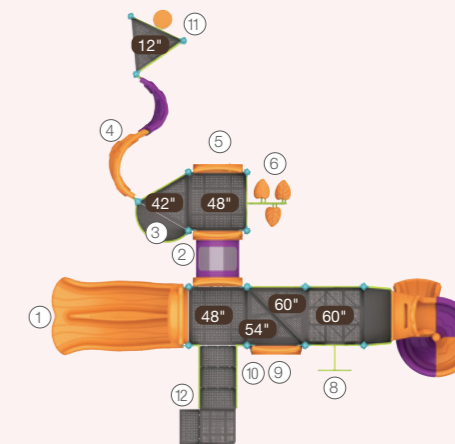

- ① 4ft Double Slide
- ② Crawl Tunnel
- ③ Balcony Deck
- ④ Vertical Rock Climber
- ⑤ Gears Panel
- ⑥ 4ft Leaf Step Climber
- ⑦ 2ft Spiral Slide
- ⑧ 5ft Snake Climber
- ⑨ ABC Panel
- ⑩ Saddle Seat
- ⑪ 12" Single Trunk Climber
- ⑫ ADA Transfer Station



SAN TAN VILLAGE
PDWP-350113C33

Ages: 5-12
Fall Height: 120"
Use Zone: 34'x35'
Equipment Size: 20'6"x20'10"x19'10"

BURST

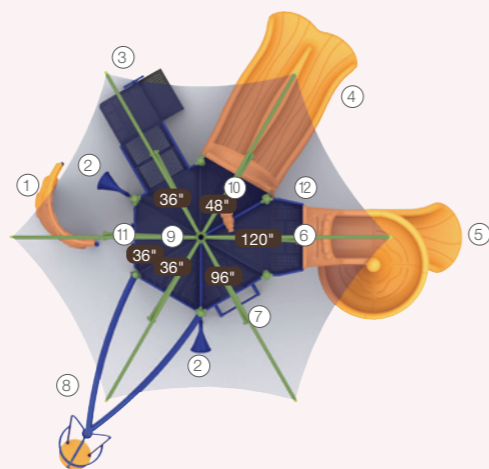

- ① Moab Rock Climber - L
- ② Talk Tube
- ③ ADA Transfer Station
- ④ 4ft Double Slide
- ⑤ 9ft Spiral Slide
- ⑥ Saddle Seat
- ⑦ 8ft Straight Rung Climber
- ⑧ Standing Corkscrew Spinner
- ⑨ Four In A Row Panel
- ⑩ Telescope
- ⑪ 3ft Upright PE Rock Climber
- ⑫ Rain Wheel



NEW



ASHEVILLE TOWER
PDWP-350143C32

Ages: 5-12
Fall Height: 108"
Use Zone: 33'x41'
Equipment Size: 21'1"x25'x17'11"

NATURAL

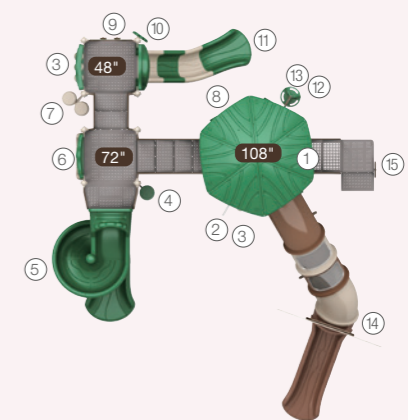

- ① Beads & Cups Panel
- ② 3ft Fireman's Pole
- ③ Tic-Tac-Toe Panel
- ④ PE Stool
- ⑤ 6ft 360° Spiral Slide
- ⑥ Saddle Seat
- ⑦ Bongo
- ⑧ Four In A Row Panel
- ⑨ 4ft Upright PE Rock Climber
- ⑩ Rain Wheel
- ⑪ 4ft Sectional Slide
- ⑫ 3ft Pod Climber
- ⑬ Gears Panel
- ⑭ 9ft S-shape Tube Slide Right Turn w/ Open Exit Chute
- ⑮ ADA Transfer Station



NEW



HUNTSVILLE LOOKOUT
PDWP-350112C32

Ages: 5-12
Fall Height: 96"
Use Zone: 49'x43'
Equipment Size: 36'9"x29'4"x17'2"

NATUREBRITE



- ① 8ft S-shape Sectional Slide
- ② Arch Bridge w/o Handrails
- ③ 3ft Pod Climber
- ④ Counter Panel
- ⑤ ADA Transfer Station
- ⑥ Rain Wheel
- ⑦ Reverse Traverse
- ⑧ ABC Panel
- ⑨ Beachcomber Structure
- ⑩ Bongo
- ⑪ 4ft Climbing Arc
- ⑫ Gears Panel
- ⑬ 6ft L-shape Tube Slide Right Turn
- ⑭ 6ft GEO Vertical Climber
- ⑮ World Map Panel
- ⑯ 3ft Wing Climber

ALLISTER
PDWP-350137C32

Ages: 5-12
Fall Height: 120"
Use Zone: 60'x45'
Equipment Size: 41'10"x31'3"x16'11"

LIMELIGHT

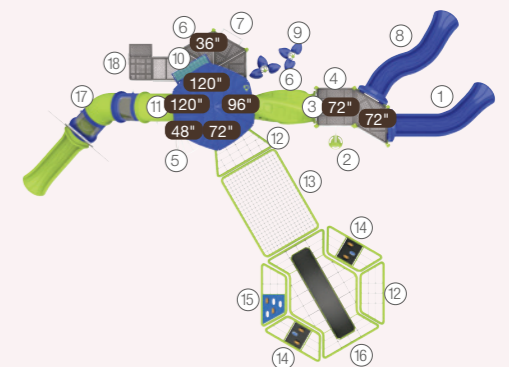

- ① Twist Challenge Crawl Tunnel
- ② 6ft Pod Climber
- ③ Counter Panel
- ④ 6ft GEO Vertical Climber
- ⑤ Twist Rung Climber
- ⑥ 3ft Upright PE Rock Climber
- ⑦ 3ft Straight Rung Climber
- ⑧ 6ft S-shape Sectional Slide
- ⑨ 2ft-4ft Upright Leaf Climber
- ⑩ Bay Window w/Barrier
- ⑪ Beads & Cups Panel
- ⑫ Trapezoid Net Climber 3ft
- ⑬ Rectangular Small-hole Net Climber 3ft
- ⑭ Trapezoid Belt Climber 3ft
- ⑮ Trapezoid Net & PE Climber 3ft
- ⑯ Polygon & Belt Walking 3ft
- ⑰ 6ft Sectional Slide 45° Left Turn w/Open Exit Chute
- ⑱ ADA Transfer Station



MERIDIANVILLE PDWP-350114C00

Ages: 5-12
Fall Height: 96"
Use Zone: 49'x49'
Equipment Size: 35'7"x33'5"x15'9"

MYSTERY

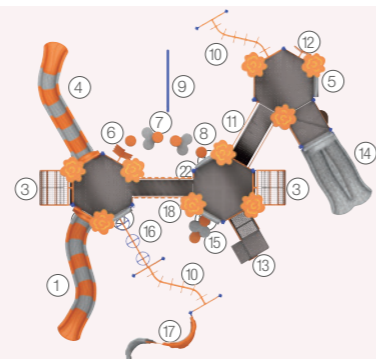

- | | |
|---------------------------------------|--------------------------------------|
| ① 8ft S-shape Sectional Slide | ② ABC Panel |
| ③ Arch Climbing Structure Bay Window | ④ 8ft Sectional Slide 45° Right Turn |
| ⑤ World Map Panel | ⑥ 8ft Wing Climber |
| ⑦ 2ft Trunk Climber | ⑧ 12" Single Trunk Climber |
| ⑨ Balance Beam | ⑩ Zig Zag Overhead Rings |
| ⑪ Arch Bridge w/o Handrails | ⑫ 3ft Wing Climber |
| ⑬ ADA Transfer Station | ⑭ 4ft Double Slide |
| ⑮ 3ft Trunk Climber | ⑯ Wheel Rings |
| ⑰ Moab Rock Climber | ⑱ Straight Bridge w/Handrail |
| ⑲ 3ft Upright PE Rock Climber (Below) | ⑳ Four In A Row Panel |
| ⑳ Gears Panel | ㉑ Puzzle Panel (Above) |



SALMON PDWP-350039C32

Ages: 2-5 & 5-12
Fall Height: 48"
Use Zone: 40'x37'
Equipment Size: 27'11"x24'4"x13'2"

SPRING

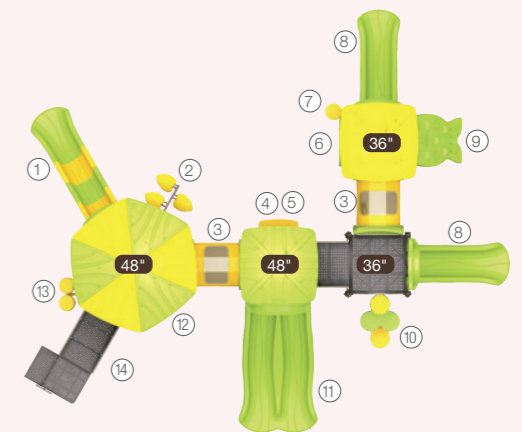

- | | |
|------------------------|-------------------------|
| ① 4ft Single Slide | ② 4ft Leaf Step Climber |
| ③ 31" Crawl Tunnel | ④ Counter Panel (Below) |
| ⑤ Maze Panel | ⑥ Gears Panel |
| ⑦ PE Stool | ⑧ 3ft Single Slide |
| ⑨ 2ft/3ft Fish Climber | ⑩ 3ft Trunk Climber |
| ⑪ 4ft Double Slide | ⑫ Puzzle Panel |
| ⑬ Bongo | ⑭ ADA Transfer Station |

NEW



WILDWOOD HEIGHTS WPPE-350012C

Ages: 5-12
Fall Height: 84"
Use Zone: 36'x31'
Equipment Size: 23'3" x 19'4" x 16'1"

GREENLAND



- ① 4 Clover Steps Bridge
- ② 2ft Inclined Belt Bridge w/Handrails 96"
- ③ Rings & Ropes Bridge 96"
- ④ 1ft Inclined Belt Steps Bridge w/Handrails 96"
- ⑤ Vertical O-zone Climber
- ⑥ 4ft PE Leaf Climber
- ⑦ 7ft Spiral Slide
- ⑧ Steps & Ropes Bridge 96"
- ⑨ 5 Clover Steps Bridge
- ⑩ 4ft Vertical PE Rock Climber
- ⑪ 3ft Vertical PE Rock Climber
- ⑫ ADA Transfer Station

SPARKLECREST PDWP-350138C3A

Ages: 2-5
Fall Height: 48"
Use Zone: 39'x31'
Equipment Size: 25'9" x 17'7" x 16'

ATTICUS

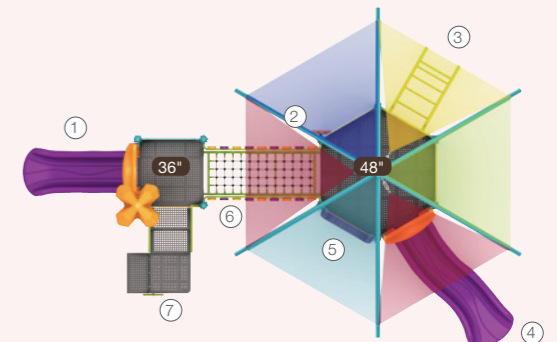

- ① 3ft Single Slide
- ② Rain Wheel
- ③ 4ft Arch Climber
- ④ 4ft Single Slide
- ⑤ Saddle Seat
- ⑥ Inclined Arch Net Bridge w/Barrier w/Tan & Midnight Rock Grain
- ⑦ ADA Transfer Station

WisePLAY Theme

WisePLAY Theme offers themed play components that bring children's most imaginative fantasies to life. From pirate ships to tree houses and castles, these structures transport children to exciting, far-off places. Designed for endless fun, WisePLAY Theme structures feature large supports, spacious platforms, and a vibrant array of colors, making them a perfect addition to parks, schools, and communities. Crafted from time-tested materials and combined with expert craftsmanship, this equipment is built to last and requires minimal maintenance. The 3.5" posts used in WisePLAY Theme structures provide a lighter, more versatile design without compromising safety or durability, ensuring you get a high-quality playground packed with engaging activities.



Scan above to learn more

3.5 WP WisePLAY ADA 3.5 3.5" Post

Castle TreeHouse Pirate Ship



ROCKET FLYER WPPE-350013C

Ages: 5-12
Fall Height: 108"
Use Zone: 42'x31'
Equipment Size: 28'2" x 15'1" x 21'1"

VOYAGE



3.5 ADA 41-45

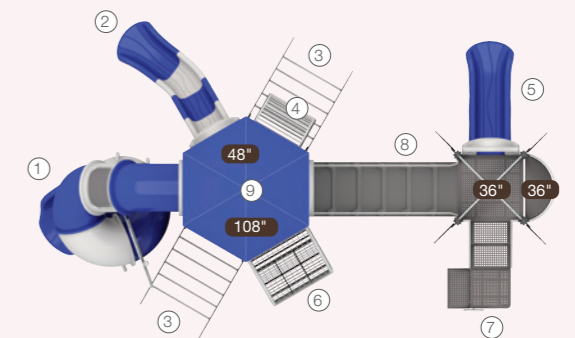

- ① 7ft Spiral Tube Slide Left Turn
- ② 4ft Sectional Slide 22.5° Left Turn
- ③ 4ft Climbing Ladder
- ④ Deck Bay Window
- ⑤ 3ft Single Slide
- ⑥ Arch Climbing Structure Bay Window
- ⑦ ADA Transfer Station
- ⑧ Belt Bridge
- ⑨ 5ft Internal Vertical Rock Climber

NEW



FIREHOUSE HOLLOW
WPPE-350024C

Ages: 2-5
Fall Height: 48"
Use Zone: 41'x30'
Equipment Size: 28'10"x17'5"x14'3"

AFTERGLOW

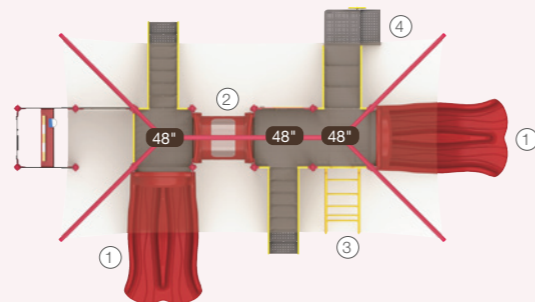

- ① 4ft Double Slide
- ② 31" Crawl Tunnel
- ③ 4ft Arch Climber
- ④ ADA Transfer Station



JUNGLE FRIENDS
WPPE-350017C

Ages: 2-5 & 5-12
Fall Height: 48"
Use Zone: 37'x24'
Equipment Size: 24'11"x12'7"x13'1"

NATUREBRITE

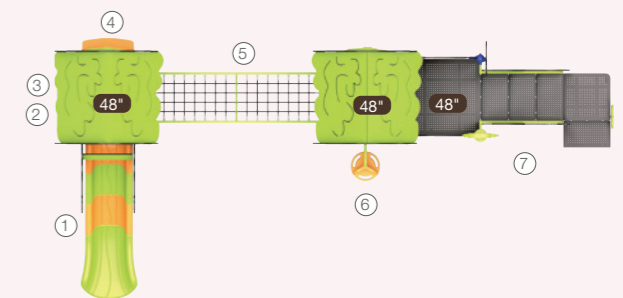

- ① 4ft Sectional Slide
- ② Marimba Panel (Below)
- ③ ABC Panel (Above)
- ④ Counter Panel
- ⑤ Arch Net Bridge w/Metal Barrier
- ⑥ 4ft Pod Climber
- ⑦ ADA Transfer Station





**SKY SEEKER
WPPE-350020C**

Ages: 2-5 & 5-12
 Fall Height: 60"
 Use Zone: 40'x36'
 Equipment Size: 27'4"x23'10"x12'1"

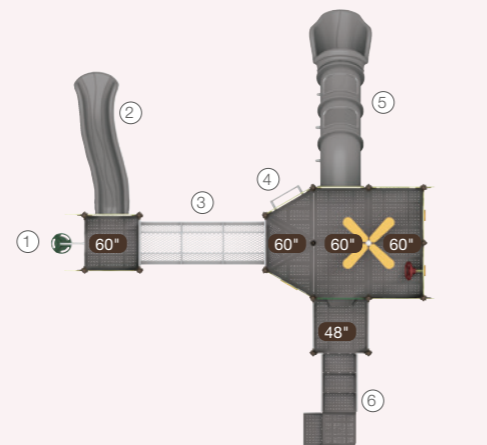

- ① 5ft Pod Climber
- ② 5ft Single Slide
- ③ Mesh Tunnel Bridge
- ④ 5ft Straight Rung Climber
- ⑤ 5ft Straight Tube Slide
- ⑥ ADA Transfer Station

**ANCHORAGE BAY
WPPE-350022C**

Ages: 2-5 & 5-12
 Fall Height: 48"
 Use Zone: 30'x31'
 Equipment Size: 17'4"x18'11"x12'2"

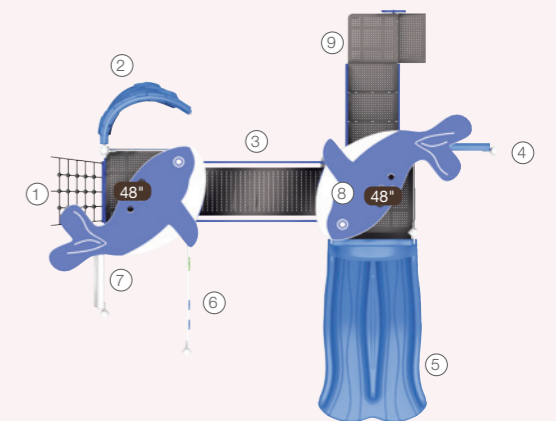

- ① Sea Fish Panel
- ② Moab Rock Climber - L
- ③ Arch Bridge w/o Handrails
- ④ Starfish Panel
- ⑤ 4ft Double Slide
- ⑥ Noah's Ark Theme - Wave Kick Plate
- ⑦ Sea Fish Panel
- ⑧ Saddle Seat
- ⑨ ADA Transfer Station



DEEP DIVER
WPPE-350018C

Ages: 2-5 & 5-12
Fall Height: 60"
Use Zone: 45'x27'
Equipment Size: 33'x14'9"x13'

INTENT

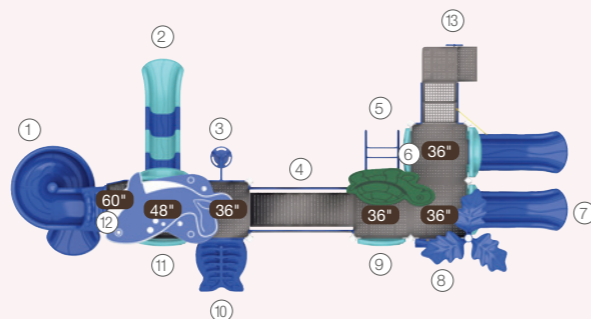

- ① 5ft Spiral Slide
- ② 3ft Pod Climber
- ③ 3ft Arch Climber
- ④ 3ft Single Slide
- ⑤ Maze Panel
- ⑥ Beads & Cups Panel
- ⑦ ADA Transfer Station
- ⑧ 4ft Sectional Slide
- ⑨ Arch Bridge
- ⑩ Puzzle Panel
- ⑪ Gears Panel
- ⑫ 2ft/3ft Fish Climber
- ⑬ ABC Panel



BRONTO | **WPPE-350014C**

Ages: 5-12
Fall Height: 36"
Use Zone: 38'x20'
Equipment Size: 26'6"x8'1"x7'1"

WETLAND

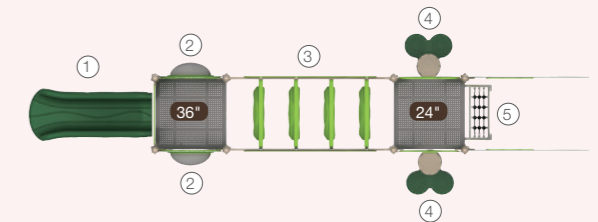

- ① 3ft Single Slide
- ② Bubble Window
- ③ O-zone rings
- ④ 2ft Trunk Climber
- ⑤ 2ft Net Climber

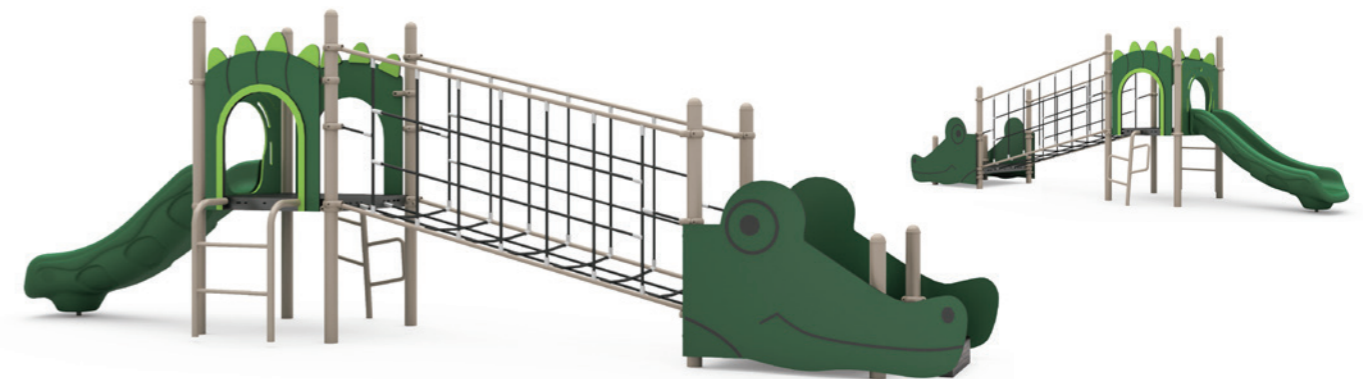

ALLIE GATOR | **WPPE-350015C**

Ages: 2-5 & 5-12
Fall Height: 36"
Use Zone: 35'x18'
Equipment Size: 22'5"x5'7"x7'

MOSSY GLADE

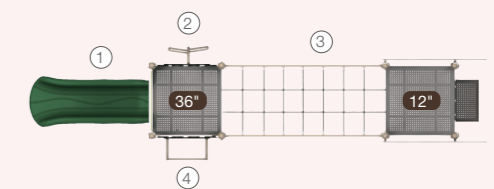

- ① 3ft Single Slide
- ② 3ft Wing Climber
- ③ Inclined Net Bridge
- ④ 3ft Straight Rung Climber



SHREVEPORT
WPPE-350003C00

Ages: 5-12
Fall Height: 120"
Use Zone: 59'x46'
Equipment Size: 44'8"x33'5"x20'10"

REFLECTION

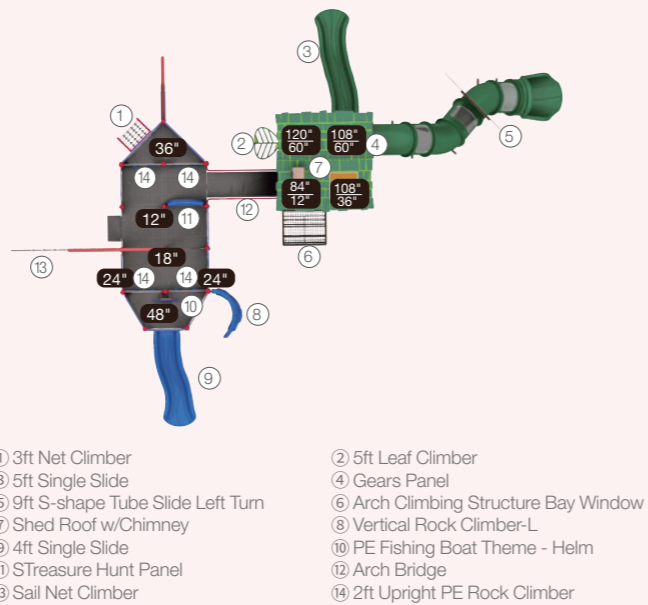

- ① 3ft Net Climber
- ② 5ft Leaf Climber
- ③ 5ft Single Slide
- ④ Gears Panel
- ⑤ 9ft S-shape Tube Slide Left Turn
- ⑥ Arch Climbing Structure Bay Window
- ⑦ Shed Roof w/Chimney
- ⑧ Vertical Rock Climber-L
- ⑨ 4ft Single Slide
- ⑩ PE Fishing Boat Theme - Helm
- ⑪ STreasure Hunt Panel
- ⑫ Arch Bridge
- ⑬ Sail Net Climber
- ⑭ 2ft Upright PE Rock Climber



FARMERS TOWER
WPPE-350009C

Ages: 5-12
Fall Height: 48"
Use Zone: 40'x35'
Equipment Size: 25'7"x19'10"x18"

FIRECRACKER

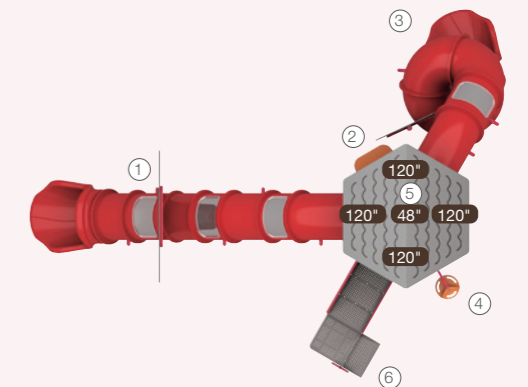

- ① 10ft Straight Tube Slide
- ② Counter Panel
- ③ 10ft Spiral Tube Slide Left Turn
- ④ 4ft Pod Climber
- ⑤ 6ft Internal Vertical Rock Climber
- ⑥ ADA Transfer Station





CHOO CHOO CABOOSE WPPE-350011C

Ages: 2-5
Fall Height: 48"
Use Zone: 42'x28'
Equipment Size: 29'8"x16'2"x8'1"

LOCOMOTIVE

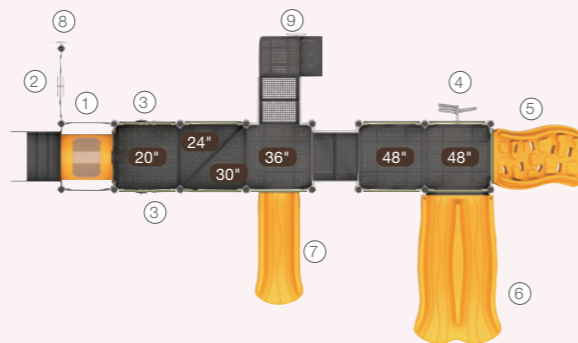

- ① Crawl Tunnel
- ② Driver Panel
- ③ Maze Panel
- ④ 4ft Wing Climber
- ⑤ Double-sided Wave Rock Climber
- ⑥ 4ft Double Slide
- ⑦ 90cm Single Slide
- ⑧ Traffic Light Panel
- ⑨ ADA Transfer Station



WISE KINGDOM BS35CS-0001

Ages: 5-12
Fall Height: 96"
Use Zone: 50'x53'
Equipment Size: 37'8"x41'5"x22'2"

TREELINE

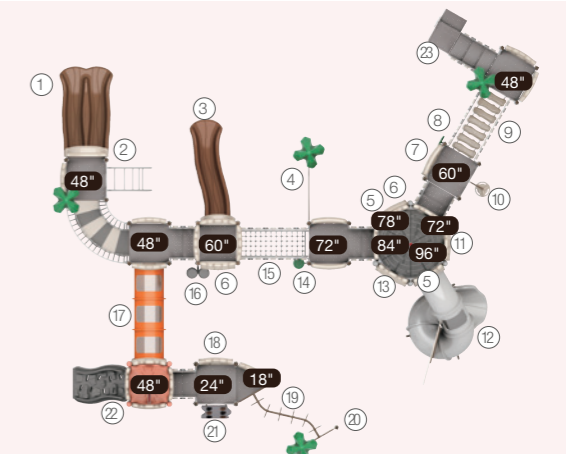

- ① 4ft Double Slide
- ② 4ft Arch Climber
- ③ 5ft Single Slide
- ④ Rung Challenge Climber
- ⑤ Visual Effects Panel (Below)
- ⑥ Clock Panel
- ⑦ World Map Panel
- ⑧ Rain Wheel
- ⑨ Step Board Bridge
- ⑩ 5ft Pod Climber
- ⑪ Four In A Row Panel
- ⑫ 8ft Spiral Tube Slide
- ⑬ Sand Clock Panel
- ⑭ PE Stool
- ⑮ Arch Net Bridge
- ⑯ Bongo
- ⑰ Crawl Tunnel
- ⑱ Counter Panel
- ⑲ Zig Zag Overhead Rings
- ⑳ Entry Ladder
- ㉑ ADA Transfer Station
- ㉒ 4ft/5ft Wave Climber



WiseMAX

WiseMAX systems take play to the next level with robust 5" posts, offering superior strength and stability compared to standard 3.5" posts. This enhanced design ensures these systems can handle high volumes of enthusiastic users, maintaining the excitement and energy that keeps the flow of play alive.

Crafted with precision using time-tested, reliable materials and expert craftsmanship, WiseMAX equipment is built to last. The durable construction not only minimizes maintenance needs over time but also guarantees that your play space remains a safe, inviting, and vibrant hub for children's development and exploration. With WiseMAX, you're investing in a play system that's as enduring as the joy it brings!

Scan



Scan above to learn more

- 153 WiseMAX Inclusive
- 161 WiseMAX Custom
- 169 WiseMAX Theme



MINA PDAT50CL-0016C

Ages: 5-12

Fall Height: 96"

Use Zone: 71'x59'

Equipment Size: 57'4"x45'8"x18'2"

NATURAL

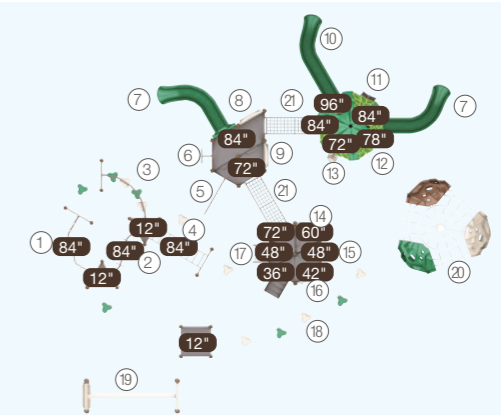

- ① 90° Overhead Swing Rings
- ② Zig Zag Overhead Rings
- ③ 90° Clover Steps Bridge
- ④ Deck to ground Challenge Ladder
- ⑤ 6ft Climbing Arc
- ⑥ 7ft Snake Climber
- ⑦ 7ft Sectional Slide Left Turn
- ⑧ Four In A Row Panel
- ⑨ World Map Panel
- ⑩ 8ft Sectional Slide 45° Right Turn
- ⑪ 7ft Wing Climber
- ⑫ 6ft Fireman's Pole
- ⑬ 6ft Pod Climber
- ⑭ Sand Clock Panel
- ⑮ 4ft Leaf Climber
- ⑯ Gears Panel
- ⑰ 4ft Net Climber
- ⑱ Track Ride
- ⑲ Canyon Lands
- ⑳ Arch Net Bridge w/Metal Barrier

WiseMAX Inclusive

At Wisdom Playgrounds, we recognize that our designs impact not only children but also the parents and caregivers who accompany them. We prioritize creating play environments that cater to individuals of all abilities, ensuring no one is left out.

By following key design principles, our inclusive playgrounds provide access to engaging play experiences for everyone. One essential aspect is offering a variety of similar activities in close proximity. This approach allows individuals with limited physical abilities to participate alongside others engaging in more advanced versions of the same activity. At Wisdom, we believe play is for everyone.

Our WiseMAX Inclusive playgrounds feature 5" OD galvanized steel support posts, combining artistic design with superior durability. Without compromising on safety or quality, we deliver playgrounds brimming with inclusive, engaging activities for all.

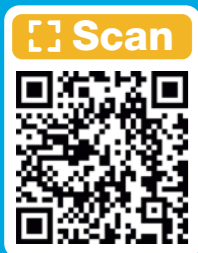

Scan above to learn more



WiseMAX



Inclusive



ADA



5" Post



SUNSHINE SUMMIT PDAT50CL-0003C

Ages: 5-12

Fall Height: 120"

Use Zone: 80'x58'

Equipment Size: 65'4"x45'8"x22'3"

POWER

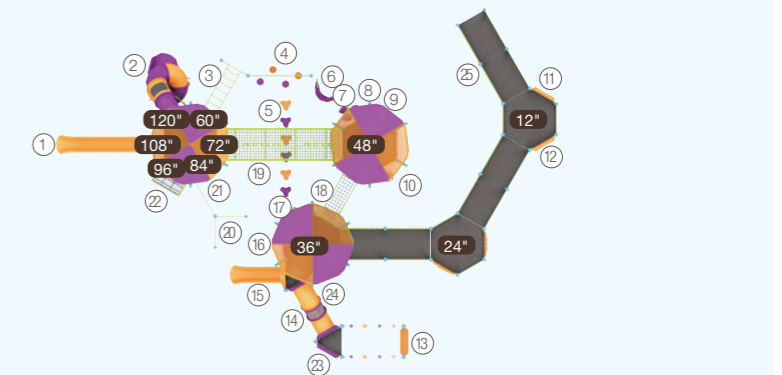

- ① 9ft Sectional Slide
- ② 10ft Spiral Tube Slide Right Turn
- ③ Invert Arch Ladder
- ④ Swing Discs
- ⑤ 12" Clover Spring Step
- ⑥ Moab Rock Climber
- ⑦ 4ft Leaf Step Climber
- ⑧ 4ft Wing Climber
- ⑨ Marimba Panel
- ⑩ 3ft Pod Climber
- ⑪ Four In A Row Panel
- ⑫ World Map Panel
- ⑬ Rope Challenge Bridge
- ⑭ S-shape Crawl Tunnel
- ⑮ 4ft Single Slide
- ⑯ 5 Inclined Arch Net Bridge w/ Metal Barrier
- ⑰ Maze Panel
- ⑱ 24" Inclined Lateral Link Bridge 192"
- ⑲ Single Rod
- ⑳ 4ft Pod Climber
- ㉑ Gears Panel
- ㉒ Arch Climbing Structure Bay Window
- ㉓ ADA Ramp
- ㉔ Puzzle Panel
- ㉕ 8ft Net Climbing

NEW

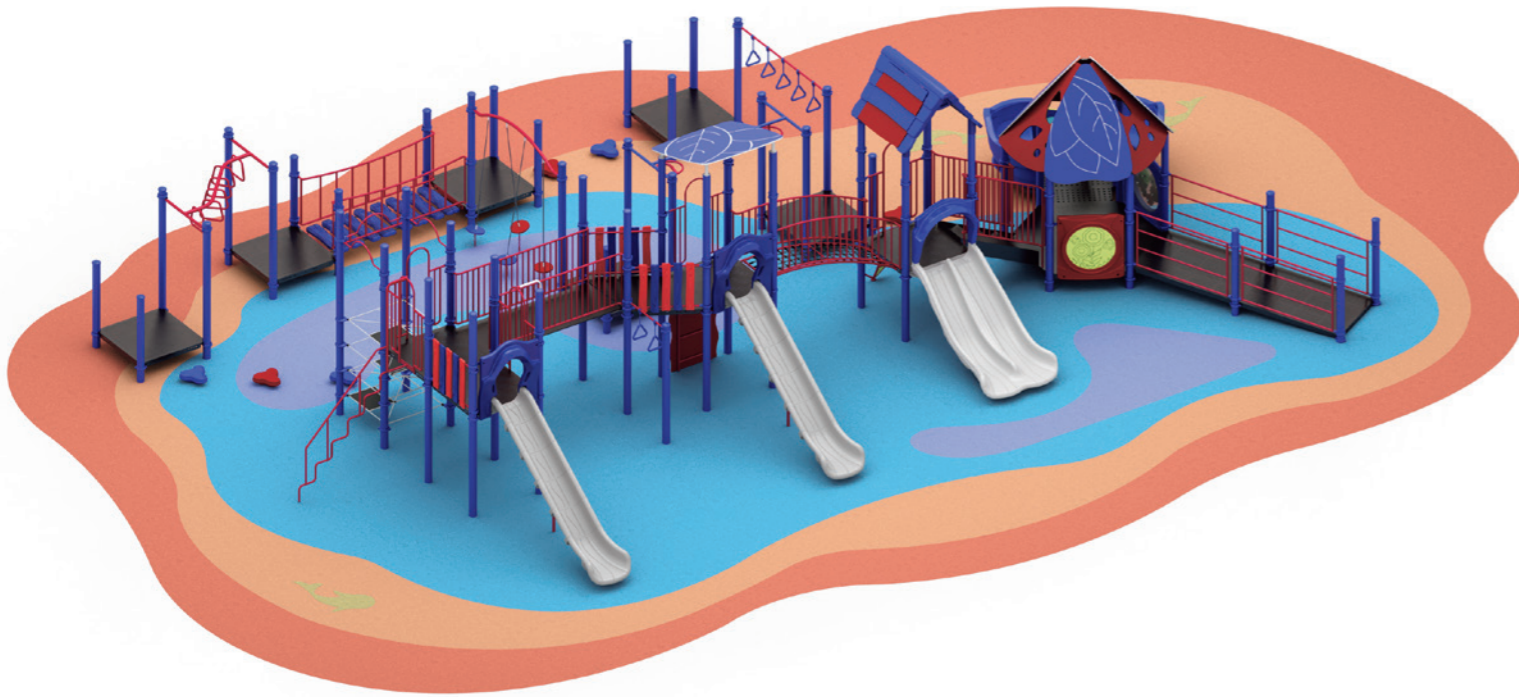

ANCHORLIGHT POINT PDAT50CL-0017C

Ages: 5-12
Fall Height: 84"
Use Zone: 68'x50'
Equipment Size: 56'2"x38'x14'9"

FORGE & FROST

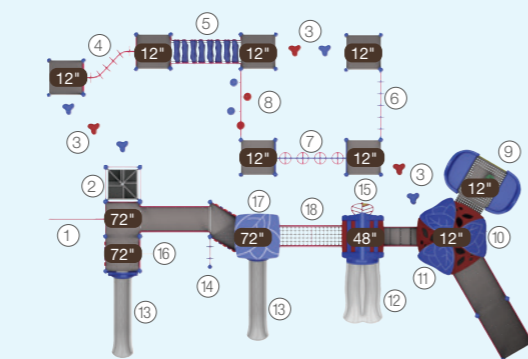

- ① 6ft Stairs Climber
- ② Square Net Climber - Single Unit
- ③ Clover Steps
- ④ Zig Zag Overhead Rings
- ⑤ Step Board Bridge w/Handrail
- ⑥ 96" Straight Horizontal Loop Ladder
- ⑦ Overhead Rotating Rings
- ⑧ Swing Discs
- ⑨ Stylish Rocking Boat
- ⑩ Gears Panel
- ⑪ Four In A Row Panel
- ⑫ 4ft Double Slide
- ⑬ 6ft Sectional Slide
- ⑭ Straight Horizontal Loop Ladder
- ⑮ 4ft Leaf Climber
- ⑯ 6ft Fireman's Pole
- ⑰ 6ft Upright PE Rock Climber
- ⑱ Inclined Net Bridge
- ⑳ ADA Ramp

NEW



GIZMO PDAT50CL-0018C

Ages: 5-12
Fall Height: 84"
Use Zone: 45'x49'
Equipment Size: 33'1"x37'7"x12'3"

POWER

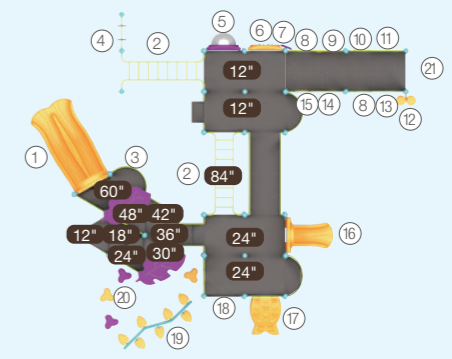

- ① 5ft Double Slide
- ② Overhead Wavy Challenge Ladder
- ③ Counter Panel
- ④ Straight Horizontal Loop Ladder
- ⑤ Bubble Window Panel
- ⑥ Gears Panel
- ⑦ Rain Wheel
- ⑧ Puzzle Panel
- ⑨ Four In A Row Panel
- ⑩ Beads & Cups Panel
- ⑪ Visual Effects Panel
- ⑫ Bongo
- ⑬ Sand Clock Panel
- ⑭ World Map Panel
- ⑮ Maze Panel
- ⑯ 2ft/3ft Fish Climber
- ⑰ 2ft/3ft Fish Climber
- ⑱ 96" Leaf Balance Steps
- ⑲ 96" Leaf Balance Steps
- ⑳ 18" Clover Step
- ㉑ ADA Ramp

NEW



WANDERWOOD CANOPY PDAT50CL-0019C

Ages: 5-12
Fall Height: 84"
Use Zone: 60'x50'
Equipment Size: 47'2"x43'2"x16'8"

NATUREBRITE



- ① Qubest Climber Entry
- ② 4ft Trunk Climber
- ③ Numbers & Letters Panel
- ④ Food Match Panel
- ⑤ 6ft Sectional Slide
- ⑥ Honeycomb Net Climber 52"
- ⑦ 7ft Sectional Slide
- ⑧ Square Net Climber - Single Unit
- ⑨ 6ft PE Rock Climber
- ⑩ 6ft Snake Climber
- ⑪ 90° Overhead Swing Rings
- ⑫ Challenge Ladder
- ⑬ Rock & Roll On
- ⑭ Clover Steps
- ⑮ ADA Ramp



NEW



SALT PETAL PDAT50CL-0020C

Ages: 5-12
Fall Height: 60"
Use Zone: 56'x50'
Equipment Size: 43'10"x35'10"x12'10"

BLUE HAVEN

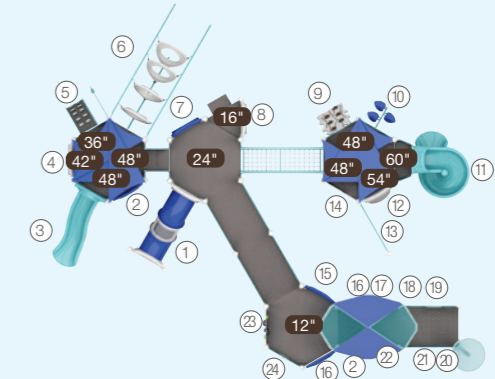

- ① S-shape Crawl Tunnel
- ② Beads & Cups Panel
- ③ 4ft Single Slide
- ④ Four In A Row Panel
- ⑤ H90 Arch Grab Climber
- ⑥ 4ft Arch O-zone Climber
- ⑦ Green Leaf Window Panel
- ⑧ ABC Panel
- ⑨ 4ft PE Trunk Rock Climber
- ⑩ 4ft Leaf Step Climber
- ⑪ 5ft Spiral Slide
- ⑫ Bubble Window Panel
- ⑬ Net Climber
- ⑭ 4ft Vertical PE Rock Climber
- ⑮ Maze Panel
- ⑯ Puzzle Panel
- ⑰ Sand Clock Panel
- ⑱ Jungle Adventure Panel
- ⑲ Visual Effects Panel
- ⑳ Growth Ring & Beads & Clock Panel
- ㉑ PE Leaf Theme Music Panel
- ㉒ World Map Panel
- ㉓ Driver Panel
- ㉔ 24" Inclined Arch Net Bridge w/Metal Barrier
- ㉕ ADA Ramp





ROCHESTER PDAT50CL-0002C

Ages: 5-12
Fall Height: 120"
Use Zone: 73'x52'
Equipment Size: 58'5"x37'8"x20'1"

SPRING



- ① Sling Seat
- ② H60 Elastic Climber
- ③ Beads & Cups Panel
- ④ 2ft/3ft Fish Climber
- ⑤ Inclined Step Board Bridge w/Net Barrier
- ⑥ Harp Panel
- ⑦ 5ft Single Slide
- ⑧ Drums Panel
- ⑨ 9ft S-shape Tube Slide Left Turn
- ⑩ Four In A Row Panel
- ⑪ Bubble Window Panel
- ⑫ Challenge Ladder
- ⑬ Horizontal O-zone Climber
- ⑭ Round Climbing Stepper
- ⑮ Arch Climbing Structure Bay Window
- ⑯ Rock & Roll On
- ⑰ ADA Ramp

SUNSET MOUNTAIN PDAT50CL-0005C

Ages: 5-12
Fall Height: 84"
Use Zone: 66'x58'
Equipment Size: 53'11"x45'4"x14'10"

SHINE



- ① Clover Step
- ② Counter Panel
- ③ 4ft Double Slide
- ④ Inclined Arch Net Bridge w/Metal Barrier
- ⑤ 6ft Pod Climber
- ⑥ 6ft GEO Vertical Climber
- ⑦ 6ft Sectional Slide 67.5° Left Turn
- ⑧ Net Climber-Leaf
- ⑨ Net Climber-Rock
- ⑩ Net Climber - Grass & Ladybug
- ⑪ Round Horizontal Ladder
- ⑫ Swing Discs
- ⑬ Balcony Deck Barrier w/Steering Wheel
- ⑭ Balance Beam
- ⑮ 5ft Upright PE Rock Climber
- ⑯ 5ft Trunk Climber
- ⑰ 5ft Straight Rung Climber
- ⑱ 4ft/5ft Rock Climber
- ⑳ ADA Ramp

WiseMAX Custom

WiseMAX systems are engineered for superior strength and durability, featuring robust 5" posts instead of the standard 3.5" posts. This enhanced structural design allows the system to accommodate higher user volumes while maintaining a free-flowing, engaging play experience that fosters excitement and enthusiasm.

Every component is crafted using time-tested, high-quality materials that have been carefully sourced to ensure maximum reliability. Combined with the skilled craftsmanship at our manufacturing facility, this results in playground equipment that is not only exceptionally durable but also requires minimal maintenance over time. The result is a play space that remains vibrant, welcoming, and full of joy—encouraging endless opportunities for adventure and fun.

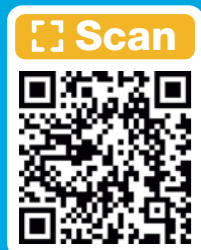

Scan above to learn more



WiseMAX



Custom



ADA



5" Post

NEW



SUNSWALLOW WILDERNESS PDAT50CL-0021C

Ages: 5-12

Fall Height: 84"

Use Zone: 81'x57'

Equipment Size: 66'8"x45'x18'3"

TWILIGHT PLAY



- ① 7ft Sectional Slide
- ② 7ft S-shape Sectional Slide
- ③ 6ft Stairs Climber
- ④ Bubble Window Panel
- ⑤ 5ft Wing Climber
- ⑥ Double Crawl Tunnel
- ⑦ 5ft Net Climber
- ⑧ Power Rungs
- ⑨ 6ft Snake Climber
- ⑩ 4ft Leaf Climber
- ⑪ Track Ride 136" Straight
- ⑫ Single Log Balance Bridge w/Handrails
- ⑬ 90° Overhead Rings
- ⑭ 5ft Arch Climber
- ⑮ 4ft/5ft Rock Climber
- ⑯ 4ft Trunk Climber
- ⑰ 36" Inclined Elastic Bridge w/Net Barrier
- ⑱ Inclined Net Bridge
- ⑲ Inclined Straight Bridge w/Metal Barrier
- ⑳ ADA Transfer Station

NEW



BOUNDLESS PDAT50CL-0022C

Ages: 5-12
Fall Height: 72"
Use Zone: 53'x37'
Equipment Size: 40'6" x 24'8" x 17'5"

FRESH AIR

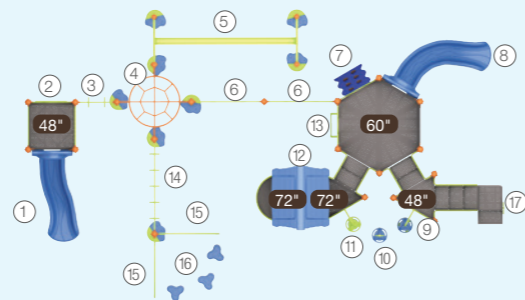

- ① 4ft Single Slide
- ② 4ft GEO Vertical Climber
- ③ Straight Horizontal Loop Ladder
- ④ Overhead Challenger
- ⑤ Track Ride 136" Straight
- ⑥ Rung Challenge Climber
- ⑦ 5ft PE Rock Climber
- ⑧ 5ft Sectional Slide 67.5° Right Turn
- ⑨ 4ft Pod Climber
- ⑩ 5ft Free Standing Pod Climber
- ⑪ 6ft Pod Climber
- ⑫ 6ft GEO Vertical Climber
- ⑬ 5ft Straight Rung Climber
- ⑭ 96" Straight Horizontal Loop Ladder
- ⑮ PE Honeycomb Climbing Arc
- ⑯ ADA Transfer Station
- ⑰ Clover Step

NEW



TRAIL TANGLE PDAT50CL-0023C

Ages: 5-12
Fall Height: 72"
Use Zone: 56'x62'
Equipment Size: 43'10" x 49'4" x 16'2"

SERENE SKY

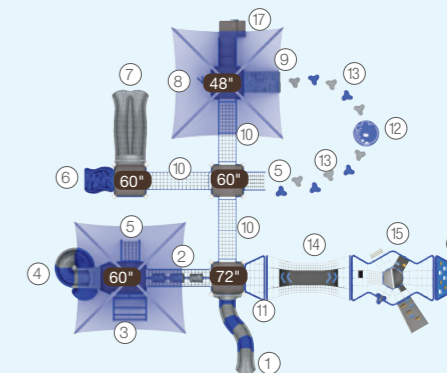

- ① 6ft S-shape Sectional Slide
- ② Inclined Trunk Link w/Metal Barrier
- ③ Arch Climbing Structure Bay Window
- ④ 5ft Spiral Slide
- ⑤ 5ft Net Climber
- ⑥ Double-sided Wave Rock Climber
- ⑦ 5ft Double Slide
- ⑧ 4ft Spiral Climber
- ⑨ 4ft/5ft Rock Climber
- ⑩ Arch Net Bridge w/Metal Barrier
- ⑪ Trapezoid Net Climber 3ft
- ⑫ Conch Standing Tri-Spring Rider
- ⑬ 6" Clover Step
- ⑭ Net & Belt Bridge 3ft
- ⑮ Polygon & Upright Net Tunnel 6ft
- ⑯ ADA Transfer Station
- ⑰ Inverted Trapezoid PE Climber 3ft



FRESHWATER PDAT50CL-0008C

Ages: 5-12
Fall Height: 84"
Use Zone: 51'x47'
Equipment Size: 38'4"x34'9"x15'9"

BRIGHT SIDE

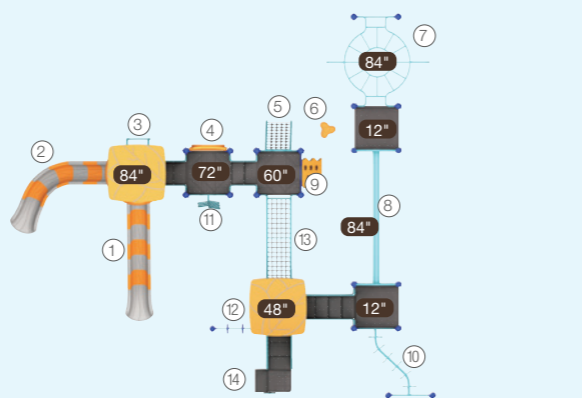

- ① 7ft Sectional Slide
- ② 7ft Sectional Slide Left Turn
- ③ 7ft Straight Rung Climber
- ④ World Map Panel
- ⑤ 5ft Net Climber
- ⑥ 12\" Clover Step
- ⑦ Round Horizontal Ladder
- ⑧ Zip Line
- ⑨ 5ft Upright PE Rock Climber
- ⑩ Zig Zag Overhead Rings
- ⑪ 6ft Wing Climber
- ⑫ Straight Horizontal Loop Ladder
- ⑬ Inclined Arch Net Bridge w/Metal Barrier
- ⑭ ADA Transfer Station



FIREFLY HIDEAWAY PDAT50CL-0014C

Ages: 5-12
Fall Height: 108"
Use Zone: 82'x55'
Equipment Size: 67'5"x41'10"x16'10"

TIDAL FLARE

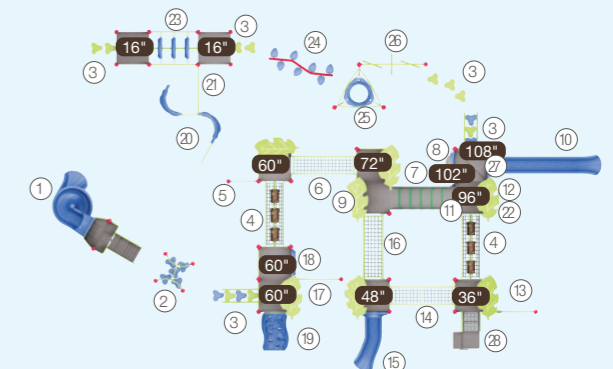

- ① 6ft Spiral Slide
- ② Round Climbing Stepper
- ③ Clover Step
- ④ Trunk Link w/Metal Barrier
- ⑤ Power Rungs
- ⑥ Step Board Bridge w/Net Barrier
- ⑦ Elastic Bridge w/Net Barrier
- ⑧ Bubble Window Panel
- ⑨ Four In A Row Panel
- ⑩ 9ft Sectional Slide
- ⑪ Gears Panel
- ⑫ 8ft Snake Climber
- ⑬ Net Climber-Leaf
- ⑭ Arch Net Bridge w/Metal Barrier
- ⑮ 4ft Sectional Slide 22.5° Right Turn
- ⑯ Inclined Net Bridge
- ⑰ Honeycomb Net Climber
- ⑱ ABC Panel
- ⑲ Double-sided Wave Rock Climber
- ⑳ Moab Rock Climber
- ㉑ Rung Challenge Climber w/Connector
- ㉒ World Map Panel
- ㉓ Horizontal O-zone Climber
- ㉔ Leaf Balance Steps
- ㉕ O-zone Climber
- ㉖ Lilly Pad Walk
- ㉗ 3ft Straight Rung Climber
- ㉘ ADA Transfer Station





ELLIE'S CHALLENGE PDAT50CL-0010C

Ages: 5-12
Fall Height: 120"
Use Zone: 73'x55'
Equipment Size: 60'9"x42'1"x10'7"

ZESTY

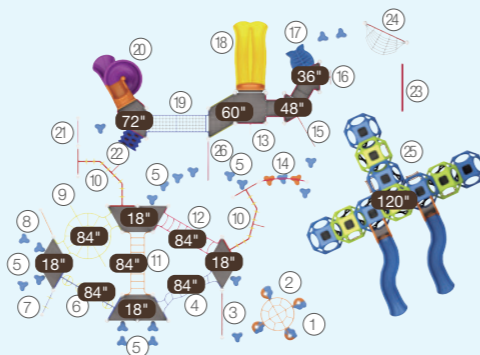
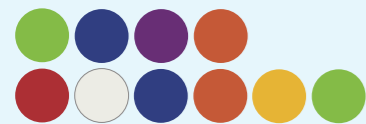

- | | | |
|-----------------------------------|----------------------------------|---------------------------|
| ① Bear Step | ② Overhead Challenger | ③ Honeycomb Net Climber |
| ④ Overhead Power Challenge Ladder | ⑤ Clover Step | ⑥ Overhead Rotating Rings |
| ⑦ Straight Horizontal Loop Ladder | ⑧ Single Bar | ⑨ Round Horizontal Ladder |
| ⑩ 90° Overhead Swinging Rings | ⑪ Overhead Wavy Challenge Ladder | ⑫ Invert Arch Ladder |
| ⑬ 5ft Fireman's Pole | ⑭ 3 Clover Steps Bridge | ⑮ 4ft Stairs Climber |
| ⑯ 3ft Snake Climber | ⑰ 2ft/3ft Fish Climber | ⑱ 5ft Double Slide |
| ⑲ Arch Net Bridge w/Metal Barrier | ⑳ 6ft Spiral Slide | ㉑ Power Rungs |
| ㉒ 6ft PE Rock Climber | ㉓ Balance Beam | ㉔ Inclined Net Climber |
| ㉕ Dragonfly | ㉖ PE Honeycomb Climbing Arc | ㉗ 5ft Fireman's Pole |

CEDAR FORT PDAT50CL-0011C

Ages: 5-12
Fall Height: 84"
Use Zone: 72'x57'
Equipment Size: 58'7"x44'11"x18'3"

TIDALPOP

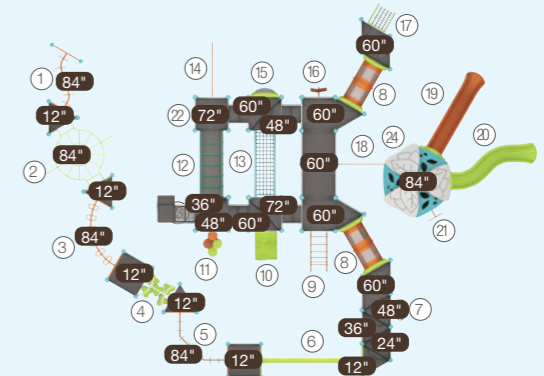

- | | | |
|----------------------------|-------------------------------|--------------------------------|
| ① Zig Zag Overhead Rings | ② Round Horizontal Ladder | ③ 90° Overhead Swing Rings |
| ④ Round Climbing Stepper | ⑤ 90° Overhead Rings | ⑥ V |
| ⑦ 4ft Leaf Climber | ⑧ Double Crawl Tunnel | ⑨ 5ft Arch Climber |
| ⑩ 4ft/5ft Rock Climber | ⑪ 4ft Trunk Climber | ⑫ Elastic Bridge w/Net Barrier |
| ⑬ Inclined Net Bridge | ⑭ 6ft Stairs Climber | ⑮ Bubble Window Panel |
| ⑯ 5ft Wing Climber | ⑰ 5ft Net Climber | ⑱ Power Rungs |
| ⑲ 7ft Sectional Slide | ⑳ 7ft S-shape Sectional Slide | ㉑ 7ft Snake Climber |
| ㉒ 6ft GEO Vertical Climber | ㉓ 3ft Upright PE Rock Climber | ㉔ 6ft Fireman's Pole |

WiseMAX Theme

WiseMAX Theme uses themed based play components that give you the opportunity to create playgrounds that mimic components from children's wildest dreams. Our pirate ships, Tree Houses, and Castles transport children to far away lands. Designed with many components for long-lasting fun. With their large supports, broad platforms, and wide array of colors any of the WisePLAY Theme components are a great addition to parks, schools, and communities.

The time tested materials sourced form and combined with the skilled craftsmanship at the factory, this equipment is durable and requires less maintenance over time.

WiseMAX Theme structures are built with 5" posts, which means they can handle end-user volumes without constricting the excitement and enthusiasm found in the flow of play. The time-tested reliability of the materials sourced for and combined with the skilled craftsmanship at the factory, produces equipment that is durable and requires less maintenance over time, so that your play space remains fun, inviting and open to the public

Scan



Scan above to learn more

5.0

WiseMAX

ADA

5.0

5" Post

Castle

TreeHouse

Pirate Ship



WiseMAX
Treehouse



BRIARSTEAD | AT50TH-0001

Ages: 5-12

Fall Height: 120"

Use Zone: 64'x45'

Equipment Size: 51'10"x32'6"x20'11"

EARTH TONE



5.0

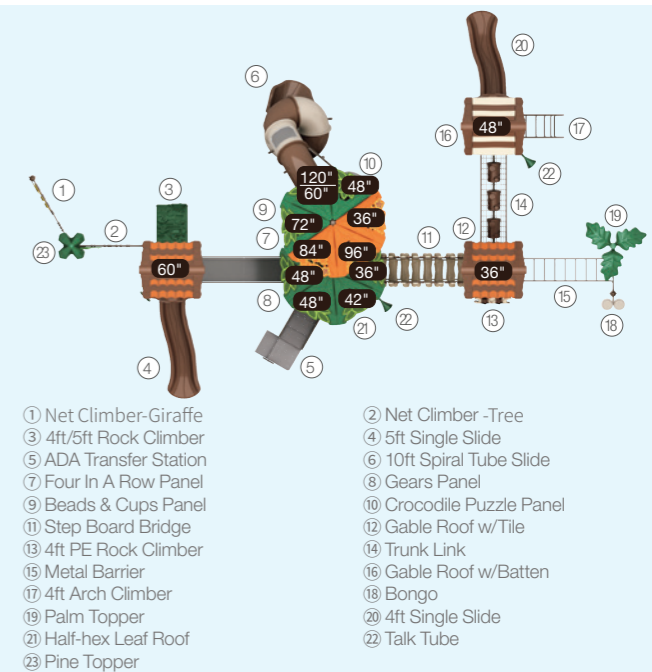



WiseMAX
Castle



CASTLE PEAK | AT50CS-0001

Ages: 5-12

Fall Height: 120"

Use Zone: 61'x51'

Equipment Size: 48'10"x37'8"x23'8"

GRANDEUR

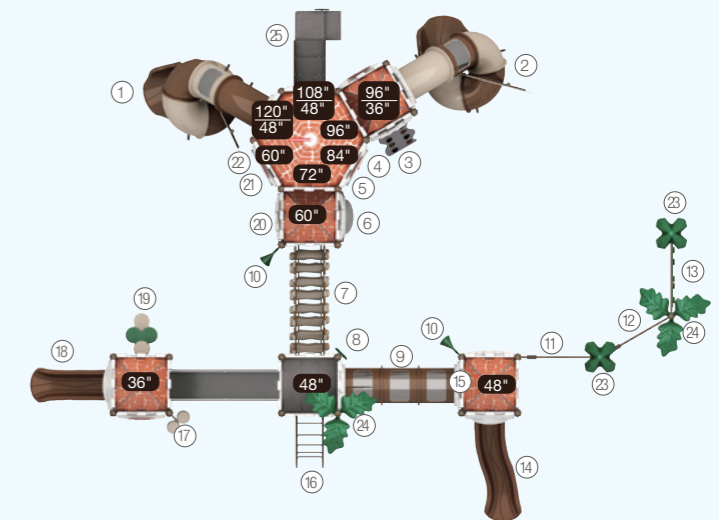

- ① 10ft Spiral Tube Slide (Gray)
- ② 8ft Spiral Tube Slide (Gray)
- ③ 3ft PE Wave Rock Climber
- ④ Clock Panel
- ⑤ Kitchen Panel (Below)
- ⑥ Bubble Window Panel
- ⑦ Step Board Bridge w/Handrail
- ⑧ Rain Wheel
- ⑨ Crawl Tunnel
- ⑩ Megaphone
- ⑪ Net Climber-Rock
- ⑫ Net Climber-Leaf
- ⑬ Net Climber-Ladybird
- ⑭ 4ft Single Slide
- ⑮ Flower Bed Panel
- ⑯ 3ft Single Slide
- ⑰ Bongo
- ⑱ 3ft Trunk Climber
- ⑲ Crocodile Puzzle Panel
- ⑳ Counter Panel (Below)
- ㉑ World Map Panel
- ㉒ Pine Topper
- ㉓ Palm Topper
- ㉔ ADA Transfer Station





WiseMAX Pirate Ship



SCALAWAGS | AT50PS-0001

Ages: 5-12
 Fall Height: 120"
 Use Zone: 67'x41'
 Equipment Size: 55'11"x28'8"x23'

HIGH SEAS

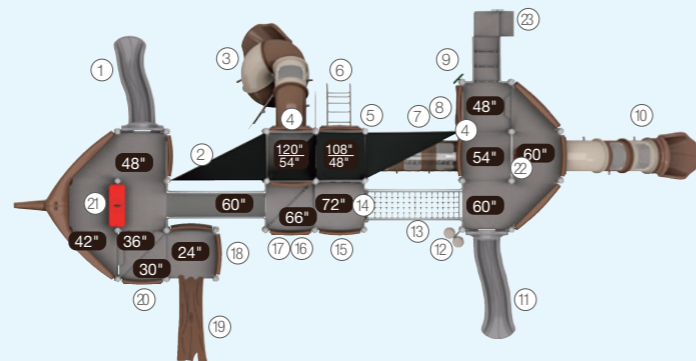

- ① 4ft Single Slide
- ② Bubble Window Panel
- ③ 10ft Spiral Tube Slide
- ④ Cannon Panel
- ⑤ Clock Panel (Above)
- ⑥ 4ft Arch Climber (Brown)
- ⑦ Crawl Tunnel
- ⑧ Drums Panel
- ⑨ Rain Wheel
- ⑩ 5ft Tube Slide
- ⑪ 5ft Single Slide
- ⑫ Bongo
- ⑬ Arch Net Bridge w/Metal Barrier
- ⑭ Kitchen Panel
- ⑮ Crocodile Puzzle Panel
- ⑯ ABC Panel (Above)
- ⑰ Counter Panel (Below)
- ⑱ Maze Panel
- ⑲ PE Diving Board
- ⑳ World Map Panel
- ㉑ Compass Worktop
- ㉒ Helm
- ㉓ ADA Transfer Station



ATLANTIS SEAS | AT50PS-0002

Ages: 2-5 & 5-12
 Fall Height: 60"
 Use Zone: 52'x41'
 Equipment Size: 39'10"x28'8"x17'

SEAFARER

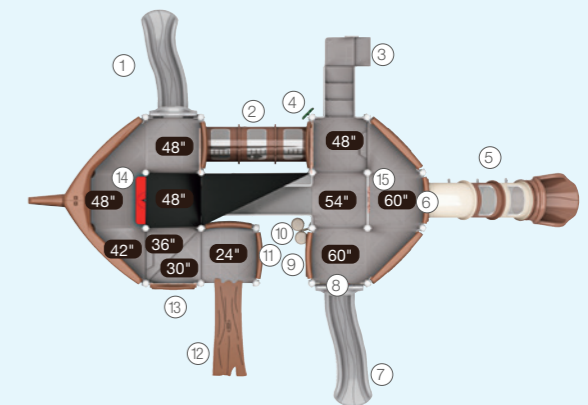

- ① 4ft Single Slide
- ② Crawl Tunnel
- ③ ADA Transfer Station
- ④ Rain Wheel
- ⑤ 5ft Tube Slide
- ⑥ Bubble Window Panel (Below)
- ⑦ 5ft Single Slide
- ⑧ Drums Panel (Below)
- ⑨ ABC Panel
- ⑩ Bongo
- ⑪ Maze Panel
- ⑫ PE Diving Board
- ⑬ World Map Panel
- ⑭ Compass Worktop
- ⑮ Helm



WiseFIT

Transform your community space with the WiseFIT series—designed to deliver the perfect blend of fun and physical challenge. This versatile collection offers an exciting variety of climbers, hanging elements, balance challenges, and slides that can be arranged individually or combined to create dynamic, imaginative play areas.

Beyond the thrill of play, WiseFIT structures promote essential developmental skills like coordination, focus, body awareness, muscular endurance, sensory integration, and controlled movement. With WiseFIT, you're not just building playgrounds—you're fostering growth, adventure, and endless possibilities for kids of all abilities.



Scan above to learn more

- 177 WiseCIRCUIT
- 178 WiseXR
- 180 WiseSite
- 181 WisePUP



www.wisdomplaygrounds.com

**LEAP PADS
LS-JSQC005**

Age: 5-12
Use Zone: 27'x16'
Equipment Size: 14'10"x3'7"x1'

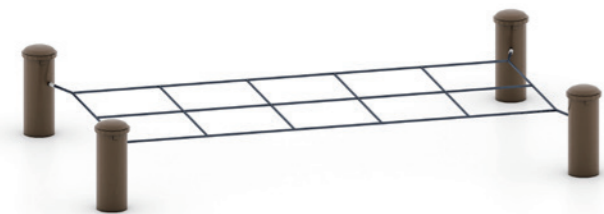
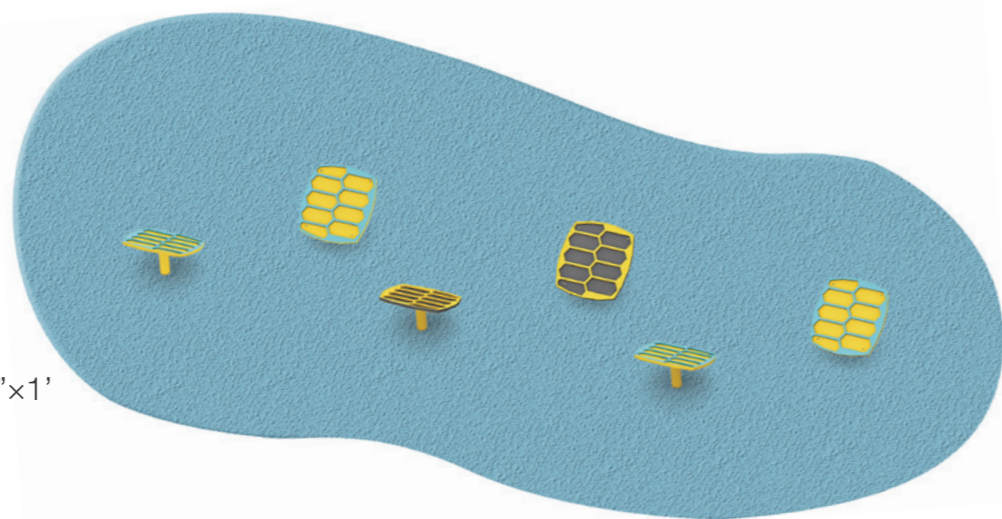

**HORIZONTAL PLAYGROUND NET
LS-JSQC004**

Age: 5-12
Use Zone: 19'x16'
Equipment Size: 6'6"x4'x1'2"



**WAVY PARALLEL BARS
LS-JSQC003**

Age: 5-12
Use Zone: 19'x15'
Equipment Size: 6'8"x2'9"x3'11"

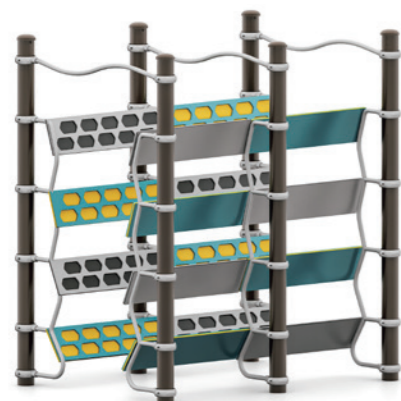

**LEAP CLIMBER
LS-JSQC001**

Age: 5-12
Fall Height: 72"
Use Zone: 20'x18'
Equipment Size: 7'6"x5'4"x8'1"

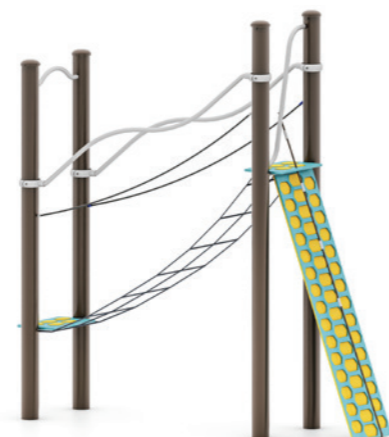

**NET & ROCK CLIMBER
LS-JSQC002**

Age: 5-12
Fall Height: 60"
Use Zone: 21'x15'
Equipment Size: 9'x2'9"x9'8"

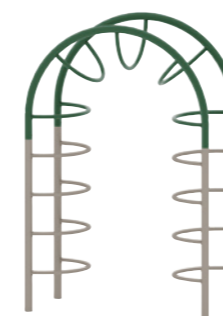

**UP & OVER CLIMBER
63-21029**

Age: 5-12
Fall Height: 89"
Use Zone: 17'x15'
Equipment Size: 4'11"x2'6"x7'5"



**DOUBLE UP & OVER CLIMBER
63-21031**

Age: 5-12
Fall Height: 89"
Use Zone: 27'x15'
Equipment Size: 14'2"x2'6"x7'5"



**WISE BAR - DUAL LEVEL
FS-CL0020N**

Age: 5-12
Fall Height: 75"
Use Zone: 20'x13'
Equipment Size: 7'2"x6"x7'1"



**WISE BAR - TRI LEVEL
FS-CL0021N**

Age: 5-12
Fall Height: 75"
Use Zone: 23'x13'
Equipment Size: 10'6"x6"x7'1"



WISE BENCH
79-23001

Age: 12+
Equipment Size: 2'4" x 3'10" x 3'2"



WISE BACK STRETCH
79-23002

Age: 12+
Equipment Size: 1'6" x 5'3" x 3'2"



WISE PUSH UP BARS
79-23003

Age: 12+
Equipment Size: 2" x 4'8" x 10"



WISE LIFT
79-23004

Age: 12+
Equipment Size: 1'4" x 1'4" x 6'10"



WISE STEP UP
79-23005

Age: 12+
Equipment Size: 3'1" x 2'9" x 7'9"



8FT RECTANGLE TABLE
DIAMOND PATTERN
SAD-21003-110

Equipment Size: 8' x 5'3" x 2'7"



46" ROUND TABLE 4 SEATS
DIAMOND PATTERN
SAD-21004-110

Equipment Size: 6'8" x 6'8" x 2'7"

ADA 46" ROUND TABLE 3 SEATS
DIAMOND PATTERN
SAD-21005-110

Equipment Size: 6'8" x 6' x 2'7"



IG
WISE CUSTOMIZABLE
BUDDY BENCH
SA-21007-110

Equipment Size: 8'1" x 2'10" x 2'10"



TRIPLE BIKE RACK
72-21017-111

Equipment Size: 1'1" x 2'



TERRIER TUNNEL
72-21059

Equipment Size: 3'11"×2'8"×3'5"

NATURE PRIMARY



PAWTASTIC TUNNEL
72-21060

Equipment Size: 4'2"×3'10"×3'10"

NATURE PRIMARY



WASTE STATION
72-21085

Equipment Size: 1'1"×1'2"×6'2"

NATURE PRIMARY



PAWTASTIC
72-21061

Equipment Size: 3'10"×6"×3'10"

NATURE PRIMARY

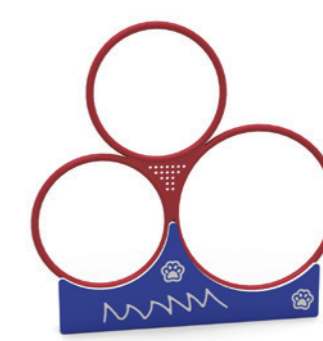

POOCH HOOPS
72-21062

Equipment Size: 4'6"×2"×4'5"

NATURE PRIMARY



BARK N' OVER
72-21055

Equipment Size: 6'12"×1'8"×3'3"

NATURE PRIMARY



PAW HOPPER
72-21056

Equipment Size: 1'4"×1'4"×12"

NATURE PRIMARY



PAW WEAVER
72-21057

Equipment Size: 6'11"×2"×2'8"

NATURE PRIMARY



PAWSITIVE JUMP
72-21058

Equipment Size: 6'3"×1'×2'5"

NATURE PRIMARY



TOTTER PAW
72-21063

Equipment Size: 6'11"×1'11"×1'5"

NATURE PRIMARY



PAWSITIVELY TABLE
72-21064

Equipment Size: 3'5"×3'5"×2'

NATURE PRIMARY



WiseWORX

Looking to bring exciting, movement-driven play to your community? WiseWORX delivers a complete lineup of innovative structures that challenge, inspire, and elevate any play space.

Each category within WiseWORX offers its own unique experience. WiseNET introduces sculpted dome formations with dynamic net routes. WiseNEX blends climbing, balance, and creative pathfinding in fresh, modern layouts. WiseCUBES stack fun with modular cube arrangements enhanced by slides and elevated play. WiseROCK adds rugged rock-wall adventures, while WiseSPHERE brings rounded, vertical climbing elements with bold visual impact. WiseTRAIN expands play variety with themed track-style movement. WiseFREE completes the collection with stand-alone favorites—from slides to sensory components and ADA-inclusive features.

Together, these systems encourage confidence, coordination, imagination, and nonstop movement, creating a play environment that grows with every child who steps into it.

- 185 WiseNET
- 189 WiseNEX
- 193 WiseQUBES
- 195 WiseROCK
- 196 WiseSPHERE
- 197 WiseTRAIN
- 199 WiseFREE



Scan above to learn more

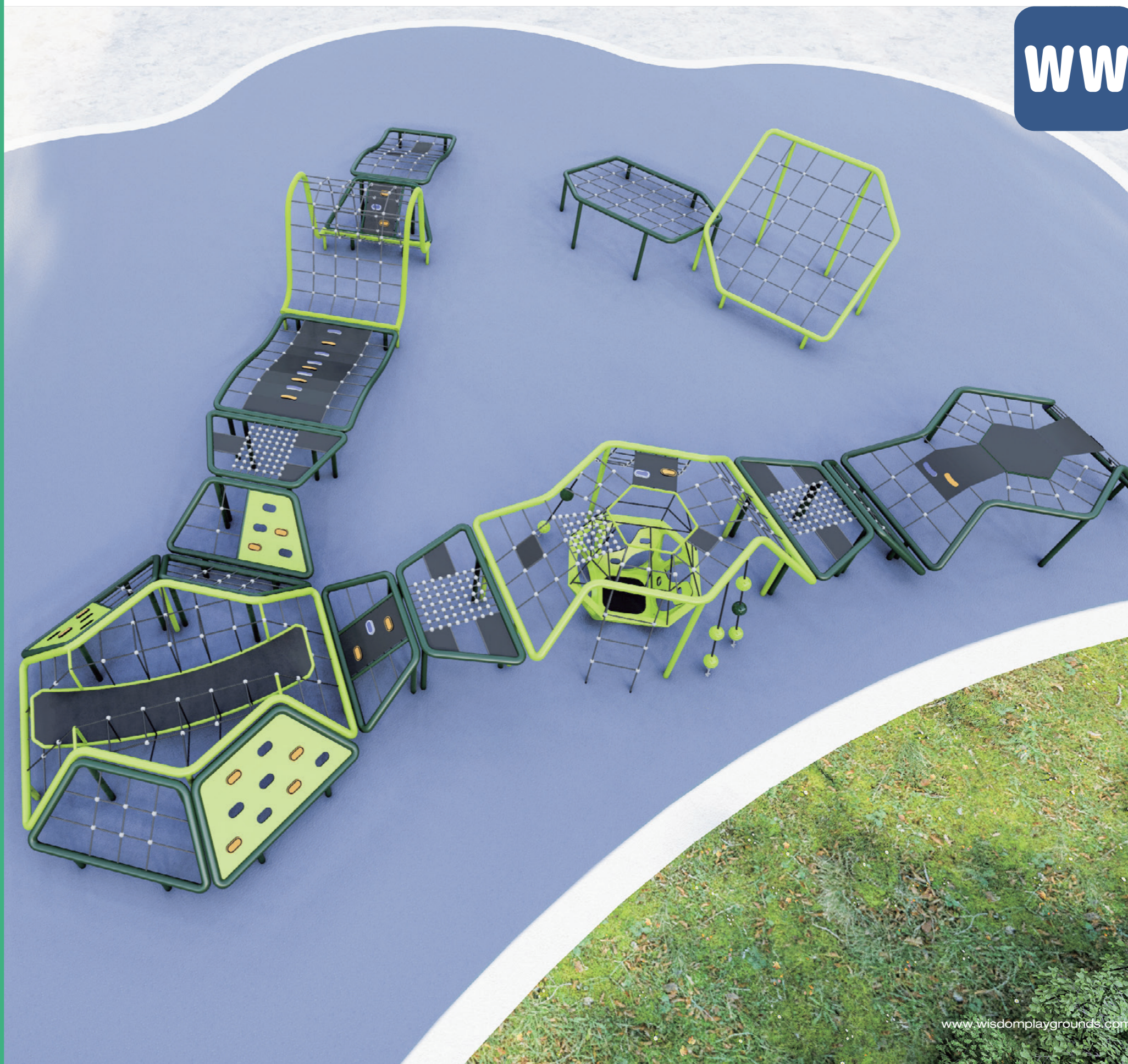

www.wisdomplaygrounds.com

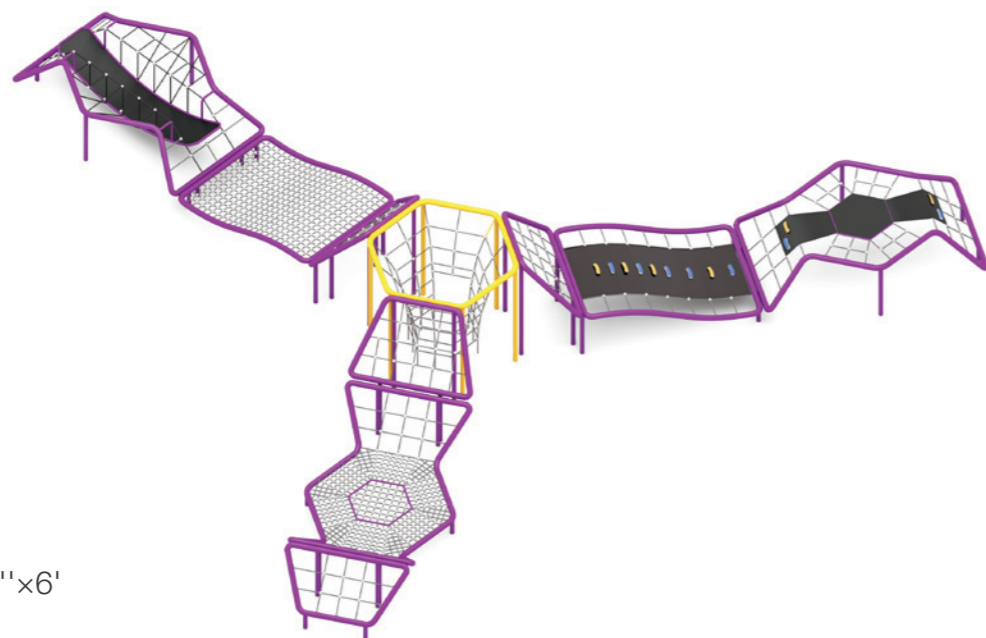

**CLIMBERS TRAVERSE
WN-002C**

Ages: 5-12
Fall Height: 72"
Use Zone: 57'x46'
Equipment Size: 44'6"x33'2"x6'



**TWISTED MESH
WN-001C**

Ages: 5-12
Fall Height: 72"
Use Zone: 49'x52'
Equipment Size: 45'6"x39'2"x6'



**WISE WEB
WN-003C**

Ages: 5-12
Fall Height: 60"
Use Zone: 48'x23'
Equipment Size: 36'3"x10'11"x12'

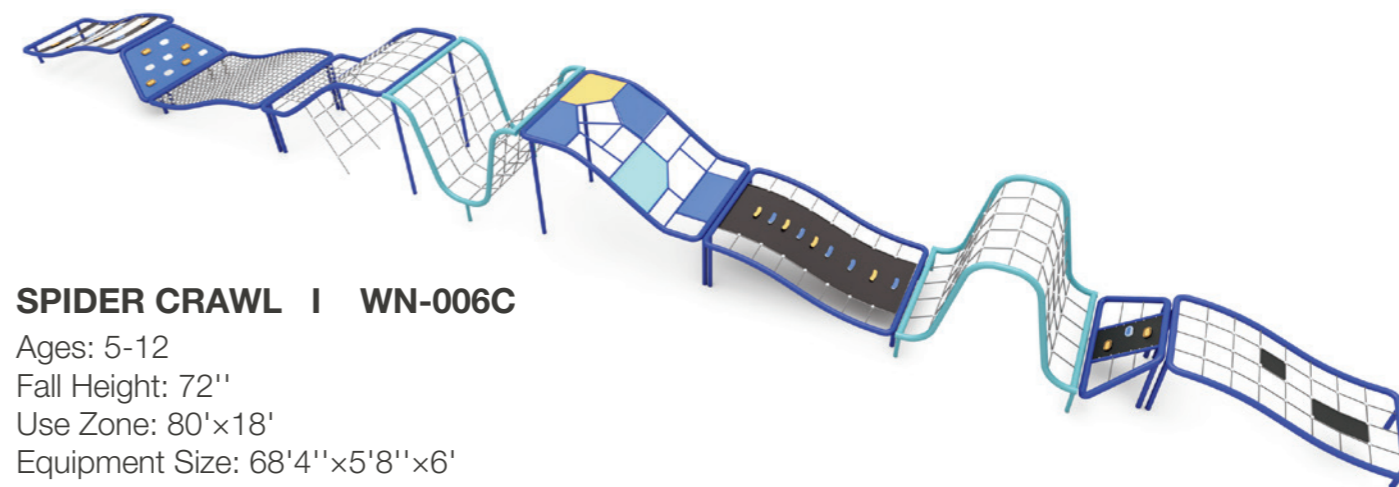

SPIDER CRAWL | WN-006C

Ages: 5-12
Fall Height: 72"
Use Zone: 80'x18'
Equipment Size: 68'4"x5'8"x6'

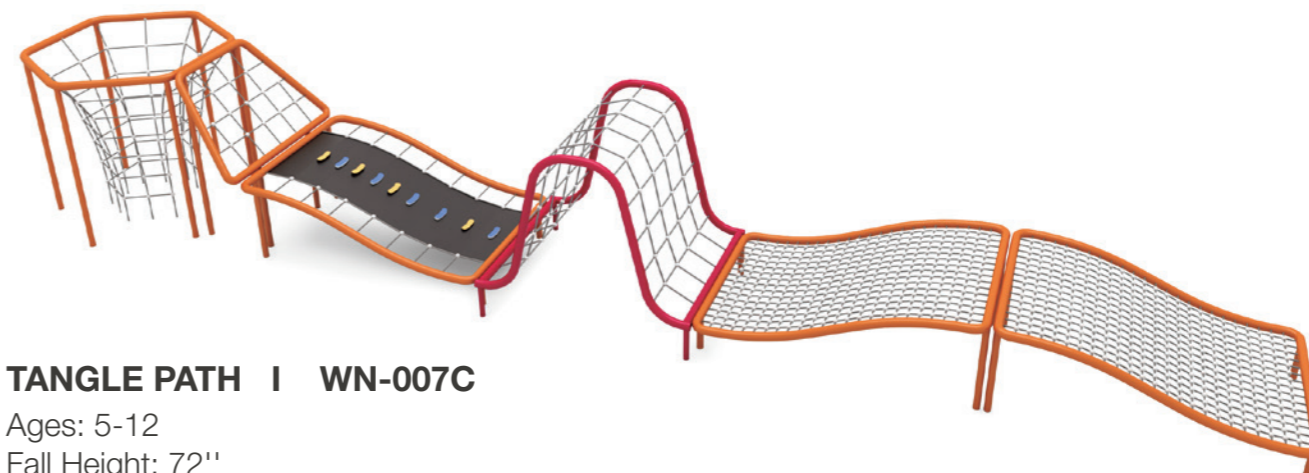

TANGLE PATH | WN-007C

Ages: 5-12
Fall Height: 72"
Use Zone: 52'x19'
Equipment Size: 40'4"x6'9"x6'



**NET RUNNER
WN-004C**

Ages: 5-12
Fall Height: 72"
Use Zone: 37'x19'
Equipment Size: 25'2"x7'4"x6'



**TRIPOD TRAVERSE
WN-005C**

Ages: 5-12
Fall Height: 60"
Use Zone: 39'x22'
Equipment Size: 26'11"x10'6"x4'10"

**ORBITER CLIMBER
WN-76-21091**

Ages: 5-12
Fall Height: 68"
Use Zone: 28'x26'
Equipment Size: 15'9"x13'7"x9'2"

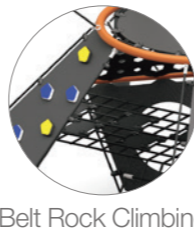
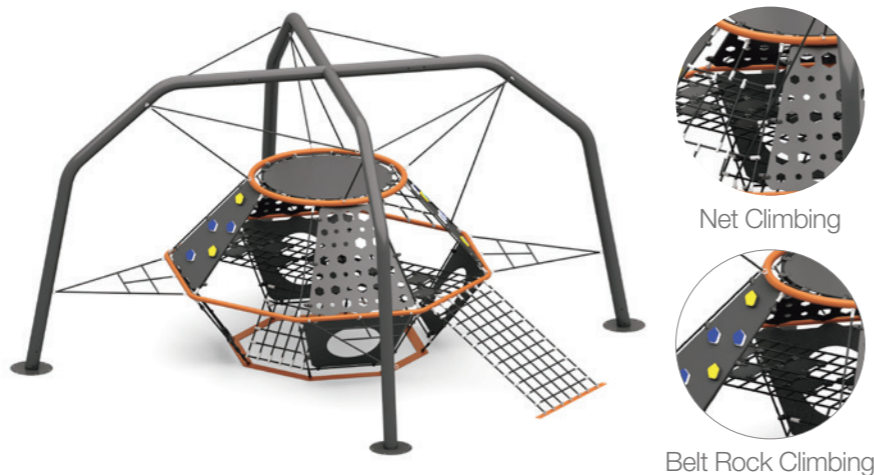

**ORB CHALLENGE
WN-74-21028**

Ages: 5-12
Fall Height: 72"
Use Zone: 26'x29'
Equipment Size: 13'7"x16'1"x9'2"



**VERTEX
WN-74-21018**

Ages: 5-12
Fall Height: 83"
Use Zone: 26'x26'
Equipment Size: 13'7"x13'7"x9'2"

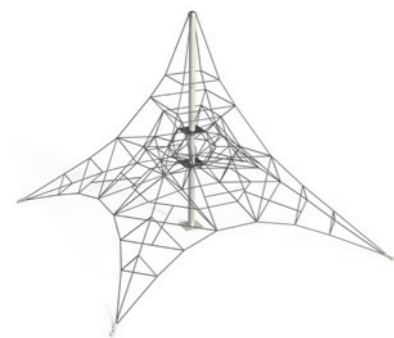

**THE RAMESSSES
WN-74-21033**

Ages: 5-12
Fall Height: 48"
Use Zone: 29'x29'
Equipment Size: 16'6"x16'6"x12'11"

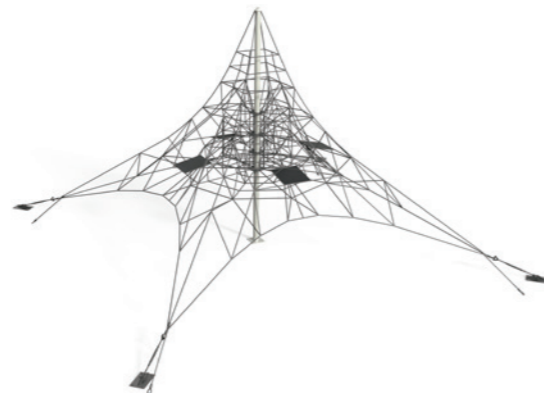

**KING TUT
WN-74-21034**

Ages: 5-12
Fall Height: 108"
Use Zone: 47'x47'
Equipment Size: 33'6"x33'6"x19'4"



NEW

**PIVOT POINT
WN-74-21107**

Ages: 5-12
Fall Height: 98"
Use Zone: 30'x30'
Equipment Size: 17'8"x17'8"x99"



**SPIDER
PDFS-CL0028C**

Age: 5-12
Fall Height: 84"
Use Zone: 32'x30'
Equipment Size: 20'x17'5"x7'5"

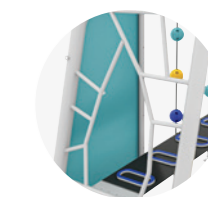
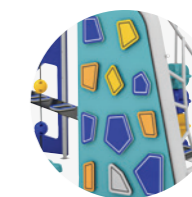
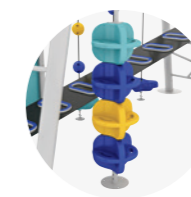

**CONVEYOR CAVE
WN-76-21092**

Ages: 5-12
Fall Height: 82"
Use Zone: 25'x18'
Equipment Size: 12'4"x6'x6'10"



**ADA SPIDER CLIMBING SET
FS-CL0032C-114122**

Age: 5-12
Fall Height: 15"
Use Zone: 28'x26'
Equipment Size: 15'7"x13'9"x5'



SPIN NEST
75-21046

Ages: 5-12
Fall Height: 21"
Use Zone: 25'x25'
Equipment Size: 6'2"x6'2"x8'3"

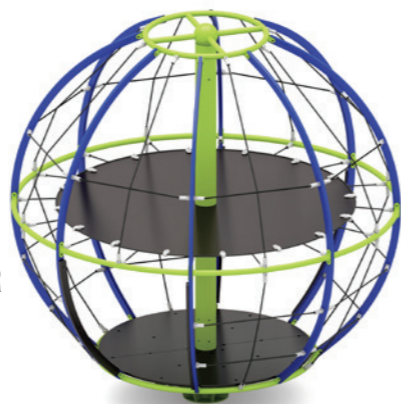

LITTLE ORBITER
75-21047

Age: 5-12
Fall Height: 103"
Use Zone: 21'x21'
Equipment Size: 8'5"x8'5"x8'8"

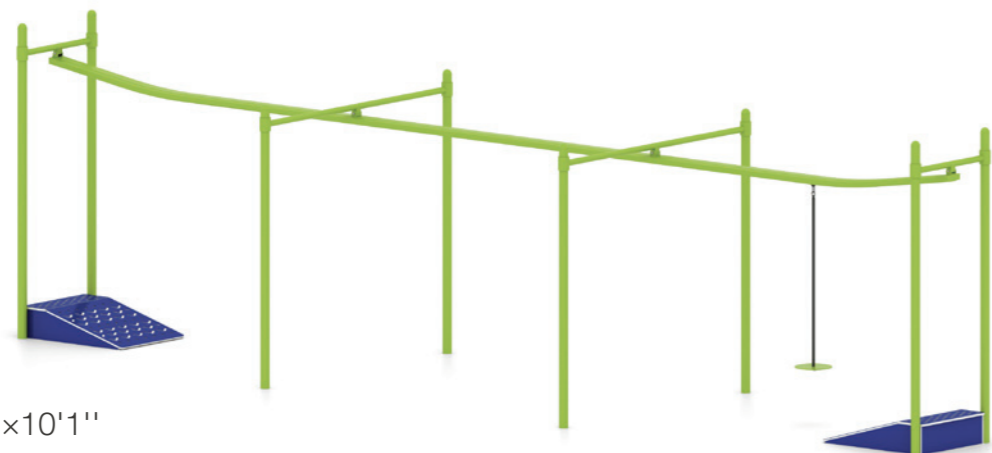

NEW

RUSH RUNNER
80-210013

Age: 5-12
Fall Height: 84"
Use Zone: 49'x16'
Equipment Size: 36'7"x9'4"x10'1"



ZOOMLINE ZIPPER
FS-CL0040

Age: 5-12
Fall Height: 84"
Use Zone: 25'x16'
Equipment Size: 13'x3'10"x8'1"



SKY REACH ASCENT CLIMBER
FS-CL3524-094BN

Age: 5-12
Fall Height: 96"
Use Zone: 28'x29'
Equipment Size: 15'3"x16'3"x8'



JUNGLE SPROUTS CLIMBER
76M-002

Age: 5-12
Fall Height: 63"
Use Zone: 21'x20'
Equipment Size: 8'10"x7'11"x13'10"



TRIFECTA CHALLENGE
PDFS-CL0024C

Ages: 5-12
Fall Height: 84"
Use Zone: 52'x38'
Equipment Size: 39'5"x25'3"x10'

TWISTED MESH

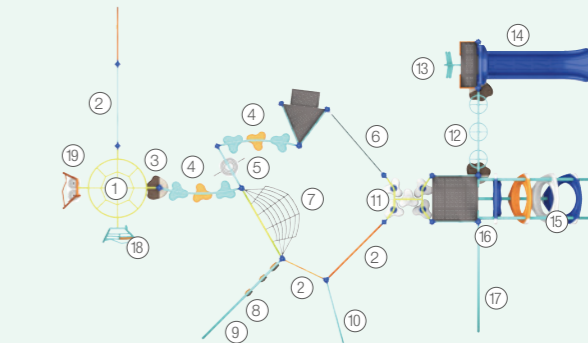

- ① Overhead Challenger
- ② Power Rungs
- ③ Bear Step
- ④ 3 Clover Steps Bridge
- ⑤ Jumbo Round Stepper
- ⑥ Rope & Rung Balance
- ⑦ Inclined Net Climber
- ⑧ Arch PE Crawl Panel
- ⑨ Climbing Arc
- ⑩ PE Honeycomb Climbing Arc
- ⑪ Round Climbing Stepper
- ⑫ Single Post Overhead Rotating Rings
- ⑬ 5ft Wing Climber
- ⑭ 5ft Sectional Slide
- ⑮ 4ft Arch O-zone Climber
- ⑯ Crescent PE Climber
- ⑰ PE Leaf Climbing Arc
- ⑱ 6ft PE Climber w/Deck

FUN WAYS PDFS-CL0011C

Ages: 5-12
Fall Height: 84"
Use Zone: 41'x32'
Equipment Size: 28'11"x19'2"x8'1"

NORTH

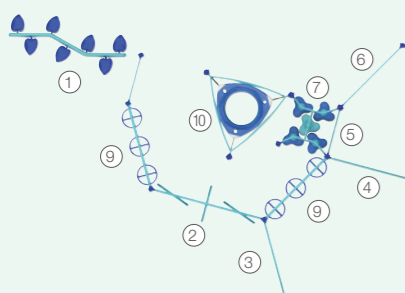

- ① Leaf Balance Beam
- ② Lilly Pad Walk
- ③ PE Honeycomb Climbing Arc
- ④ Sail PE Climbing Panel
- ⑤ Power Rungs
- ⑥ Vertical Net Link
- ⑦ Round Climbing Stepper
- ⑧ O-zone Climber
- ⑨ Single Post Overhead Rotating Rings
- ⑩ Triangle Overhead Challenger Rings



DOJO PDFS-CL0031C

Ages: 5-12
Fall Height: 96"
Use Zone: 51'x43'
Equipment Size: 38'10"x30'11"x8'10"

RETRO

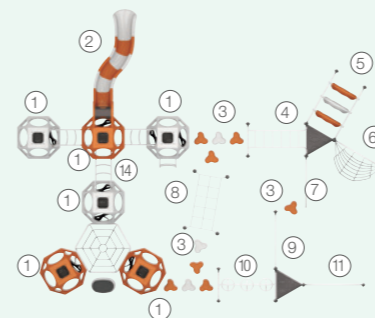

- ① Qubest
- ② 6ft S-shape Sectional Slide
- ③ 6" Clover Step
- ④ Challenge Ladder
- ⑤ Horizontal O-zone Climber
- ⑥ Inclined Net Climber
- ⑦ PE Honeycomb Climbing Arc
- ⑧ Horizontal Playground Net
- ⑨ Power Rungs
- ⑩ Overhead Rotating Rings
- ⑪ Honeycomb Net Climber



WOBBLEY WAY PDFS-CL0012C

Ages: 5-12
Fall Height: 84"
Use Zone: 42'x39'
Equipment Size: 29'2"x26'1"x8'2"

POWER

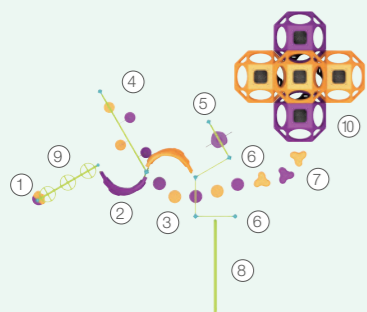

- ① Bear Step
- ② Vertical Rock Climber
- ③ 12" Single Trunk Climber
- ④ Swing Discs
- ⑤ Jumbo Round Stepper
- ⑥ Single Bar
- ⑦ 18" Clover Step
- ⑧ Balance Beam 8ft
- ⑨ Single Post Overhead Rotating Rings
- ⑩ Ruby Qube



WILDER PDFS-CL0030C

Ages: 5-12
Fall Height: 96"
Use Zone: 51'x32'
Equipment Size: 38'8"x19'1"x8'10"

BEACHY

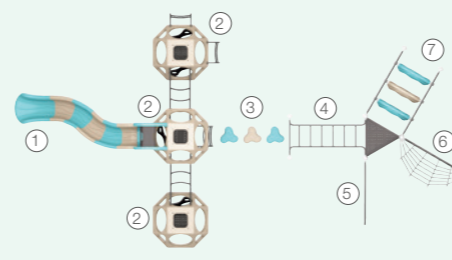

- ① 6ft S-shape Sectional Slide
- ② Qubest
- ③ 6" Clover Step
- ④ Challenge Ladder
- ⑤ PE Honeycomb Climbing Arc
- ⑥ Inclined Net Climber
- ⑦ Horizontal O-zone Climber





DRAGONFLY | PDQB-210013C

Ages: 5-12
 Fall Height: 123"
 Use Zone: 37'x38'
 Equipment Size: 24'9"x25'11"x10'3"

LIMEPOP



VISIONARY | PDQB-210010C

Ages: 5-12
 Fall Height: 96"
 Use Zone: 31'x43'
 Equipment Size: 18'2"x30'1"x8'10"

HEROIC



QUBE CLIMB AND SLIDE | QB-210012P

Ages: 5-12
 Fall Height: 108"
 Use Zone: 31'x29'
 Equipment Size: 18'3"x16'2"x8'10"

PRIMARY



DOUBLE TROUBLE QUBE | QB-210003

Age: 5-12
 Fall Height: 72"
 Use Zone: 30'x29'
 Equipment Size: 17'11"x16'5"x6'11"

GLACIER

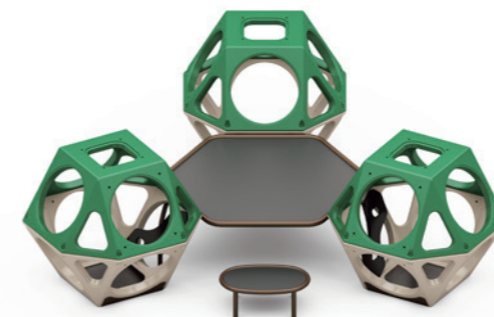
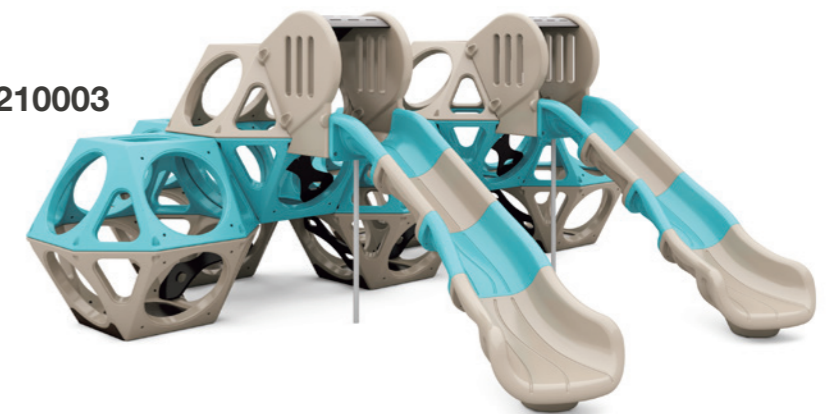

GRAVITRON | QB-210009N

Age: 5-12
 Fall Height: 48"
 Use Zone: 26'x25'
 Equipment Size: 13'6"x12'2"x4'1"

NATURE



PROFESSORS QUBE | QB-210005

Age: 5-12
 Fall Height: 72"
 Use Zone: 30'x29'
 Equipment Size: 17'11"x14'8"x6'

COPPERMIST



PARK AVENUE | MR-210006N

Age: 5-12
Fall Height: 82"
Use Zone: 43'x21'

NATURE

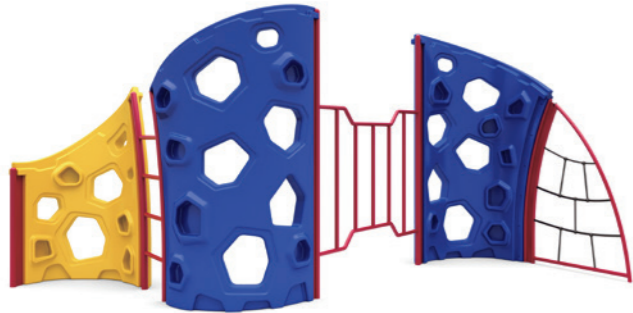

DOUBLE ARCH | MR-210005P

Age: 5-12
Fall Height: 82"
Use Zone: 28'x20'

PRIMARY



LA SAL | MR-210004C

Age: 5-12
Fall Height: 82"
Use Zone: 27'x18'

LIME SKY



BALANCED ROCK | MR-210001C

Age: 5-12
Fall Height: 82"
Use Zone: 20'x16'

LIMEFLARE



DELICATE ARCH | MR-210002C

Age: 5-12
Fall Height: 82"
Use Zone: 20'x17'

STONEWALL



THE WINDOWS | MR-210003C

Age: 5-12
Fall Height: 82"
Use Zone: 23'x23'

CINDER BURNS

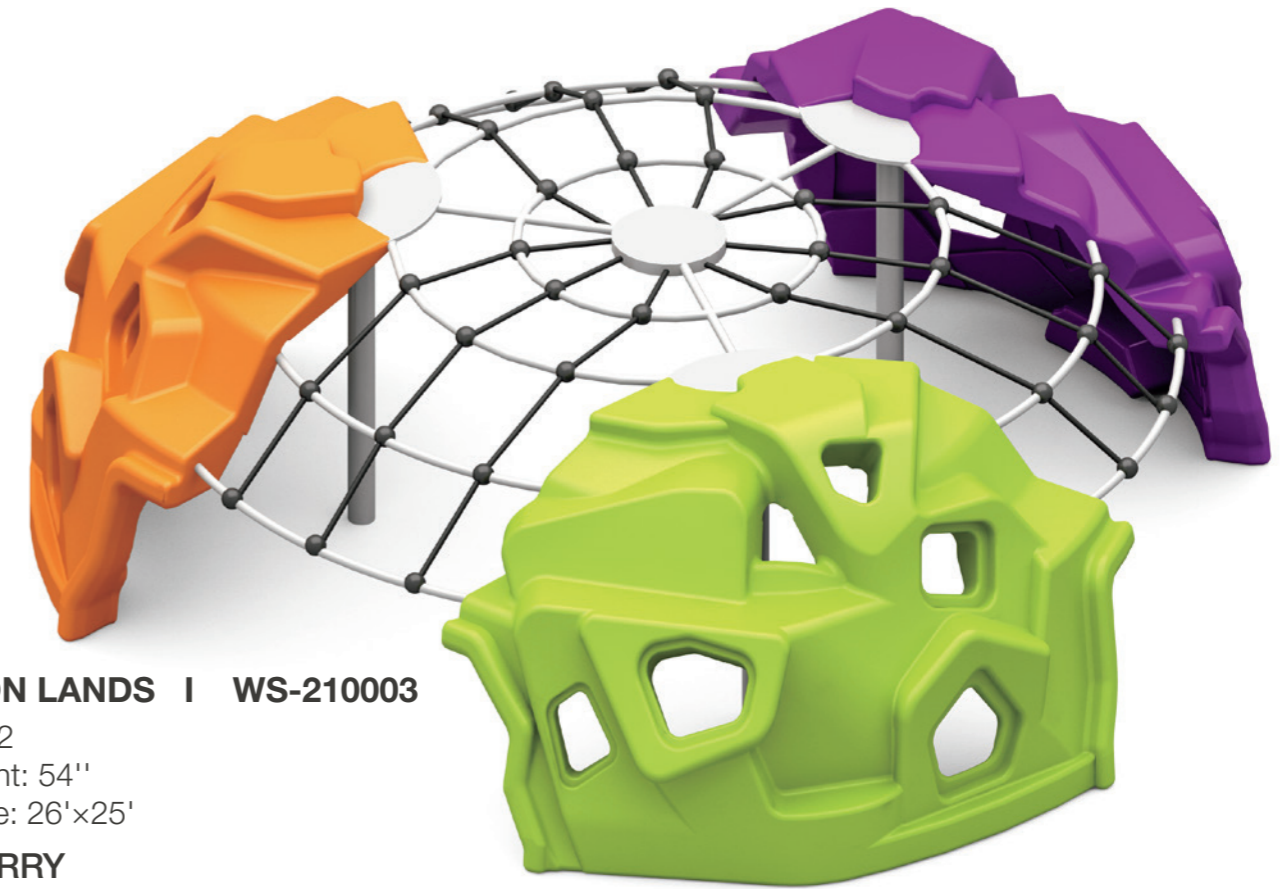

CANYON LANDS | WS-210003

Age: 5-12
Fall Height: 54"
Use Zone: 26'x25'

SUNBERRY

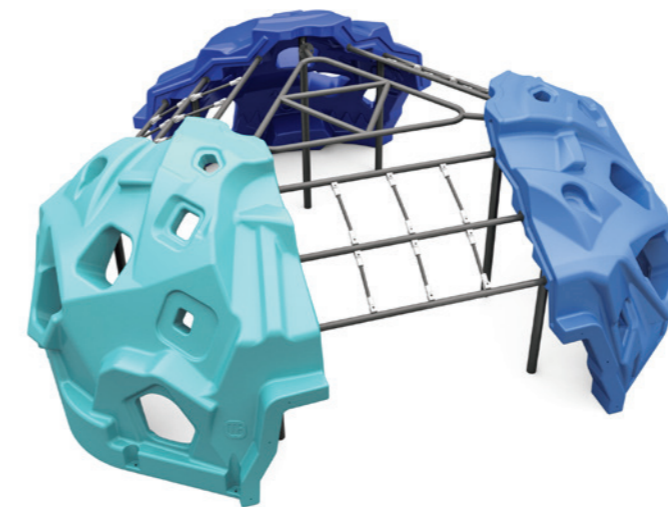

BUGGY | WS-210004

Age: 5-12
Fall Height: 54"
Use Zone: 28'x25'

SEABREEZY

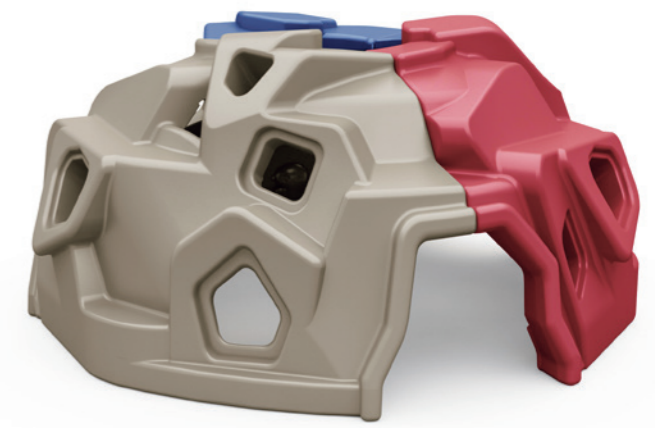

SLICKROCK | WS-210005C

Age: 5-12
Fall Height: 54"
Use Zone: 22'x22'

EMBERMIST



OUTDOOR MOTOR SKILLS-TRAIN

MECHANICAL TRAIN + WAVED RAIL DESIGN

Release children's vitality with lifelike appearance, exercise children's balance and control.

VARIOUS MODULES FOR EXTENDABLE CONNECTION

A variety of functions, including bridging/climbing/balancing/rope maze/crawling and other activity design, training children's balance, coordination, sensitivity and muscle strength.

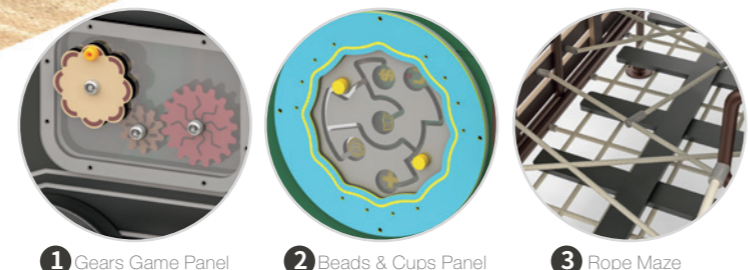

WISETRAN - REGULAR SET
HW1-S1A352

Ages: 2-5
Use Zone: 61' x 19'
Equipment Size: 48'8" x 6'9" x 6'1"

WISETRAN - CORNER SET
HW1-S1A353

Ages: 2-5
Use Zone: 39' x 41'
Equipment Size: 27' x 28'3" x 6'1"

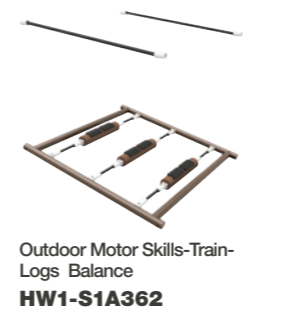
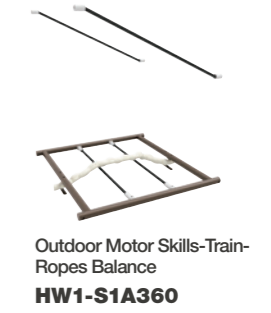
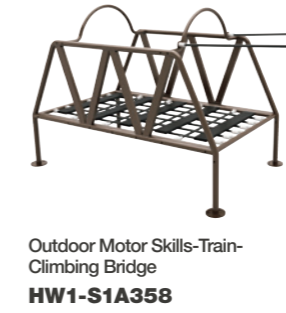



3.5 360°

**360 FREESTANDING SPIRAL SLIDE
FS-SL7200N**

Ages: 5-12
Fall Height: 72"
Use Zone: 26'x18'
Equipment Size: 13'2"x5'7"x10'



3.5 270°

**270 FREESTANDING SPIRAL SLIDE
FS-SL6000P**

Ages: 2-5 & 5-12
Fall Height: 60"
Use Zone: 23'x18'
Equipment Size: 10'9"x5'10"x9'1"



3.5

**WIGGLY RACE
FS-SL72033N**

Ages: 5-12
Fall Height: 72"
Use Zone: 31'x27'
Equipment Size: 19'x14'1"x10'1"



3.5

**4' FREESTANDING SINGLE SLIDE
FS-SL4801N**

Ages: 2-5
Fall Height: 48"
Use Zone: 25'x17'
Equipment Size: 12'7"x4'3"x8'1"



3.5

**4' FREESTANDING DOUBLE SLIDE
FS-SL4802P**

Ages: 2-5
Fall Height: 48"
Use Zone: 27'x17'
Equipment Size: 14'6"x4'8"x8'1"



**ROCK AND ROLL ON
76AM-002**

Ages: 2-5 & 5-12
Equipment Size: 9'2"x6'6"x5'2"



NEW

**TWISTY WOO
75-21072**

Ages: 2-5
Use Zone: 16'x16'
Equipment Size: 3'1"x3'3"x3'5"



NEW

**DIZZY DINO EGG
75-21073**

Ages: 2-5
Equipment Size: 3'11"x3'4"x4'10"



**TWIRL A WHIRL
75-21014-114**

Ages: 5-12
Use Zone: 23'x23'
Equipment Size: 4'2"x4'2"x3'8"



**ADA TWIRL A WHIRL
75-21039-122131**

Ages: 5-12
Use Zone: 19'x19'
Equipment Size: 6'7"x6'7"x3'5"

NEW

DOUBLE GEXX CRAWL TUBE

76-21164

Ages: 2-5
Use Zone: 25'x17'
Equipment Size: 12'2"x4'3"x5'9"



76-21164-121123



76-21164-110113



76-21164-77112

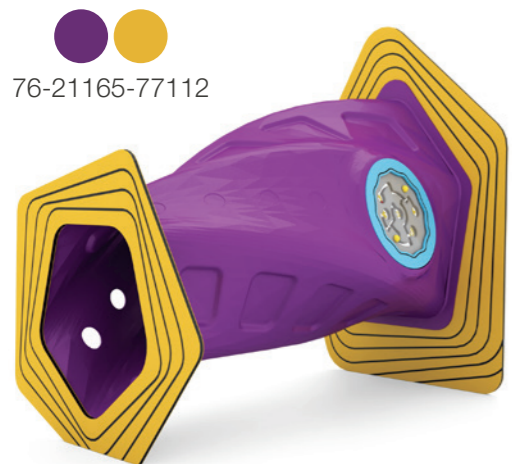

76-21165-77112

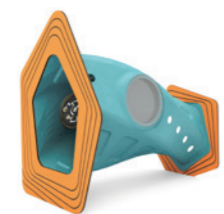

76-21165-121123

NEW

GEXX CRAWL TUBE

76-21165

Ages: 2-5
Use Zone: 19'x17'
Equipment Size: 6'1"x4'3"x5'9"

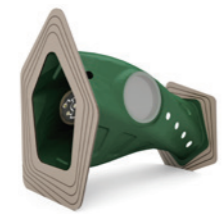

76-21165-110113

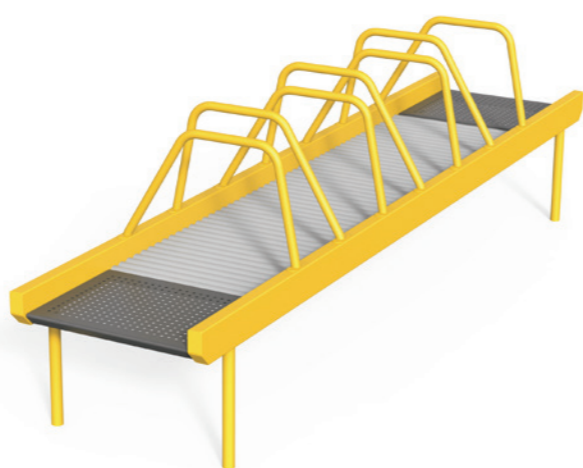

NEW

GLIDE RIDE

72-21097-112

Ages: 5-12
Use Zone: 25'x15'
Equipment Size: 13'x2'10"x3'9"

NEW

GAGA PIT

76-21137-114122

Ages: 5-12
Equipment Size: 15'8"x15'8"x2'8"



NEW

CORN BOARD

72-21098-122

Ages: 2-5
Equipment Size: 4'x5'x1'

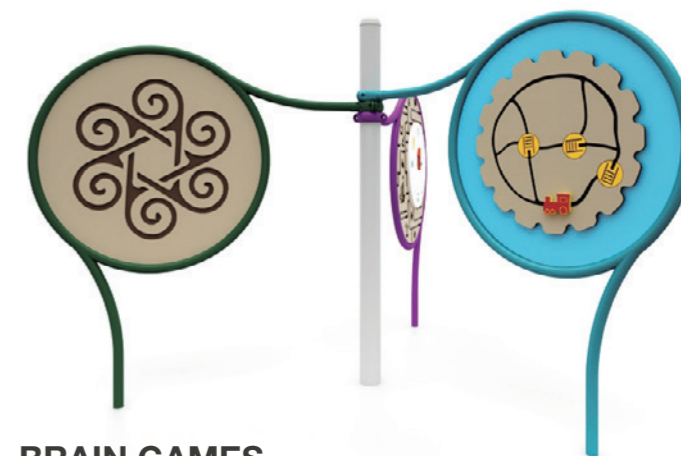

BRAIN GAMES
PDFS-CL0010C

Equipment Size: 6'5"x7'5"x5'1"

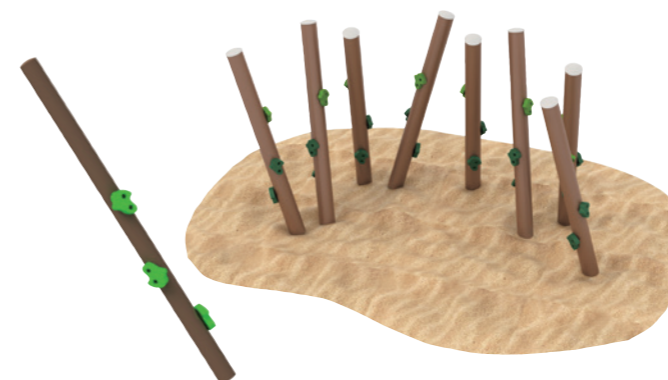

THROUGH THE JUNGLE-SINGLE
HW1-S101

Ages: 2-5 & 5-12
Equipment Size: 1'x1'10"x5'3"

THROUGH THE JUNGLE - SET OF 8
HW1-S101-1

Ages: 2-5 & 5-12
Equipment Size: 8'6"x3'11"x5'3"



CIRCLE CYCLE TRIKE
75-21024

Ages: 2-5
Use Zone: 18'x18'
Equipment Size: 5'11"x5'11"x3'3"



ASHTON'S QUIET COVE
76-21089-10114

Age: 2-5
Use Zone: 24'x20'
Equipment Size: 11'10" x 7'3" x 7'6"



SENSORY STATION PAIR
FS-WP0005C

Equipment Size: 3'11" x 3'11" x 4'2"



SENSORY STATION QUAD SET
FS-WP0002C

Equipment Size: 7'8" x 7'9" x 4'2"



WISEBOUNCE & BALANCE
SR-21010

Ages: 2-5 & 5-12
Use Zone: 23' x 16'
Equipment Size: 10'8" x 3'2" x 3'10"



WISESAW - QUAD
SR-21012-113

Ages: 2-5 & 5-12
Use Zone: 21' x 21'
Equipment Size: 8'2" x 8'2" x 2'4"

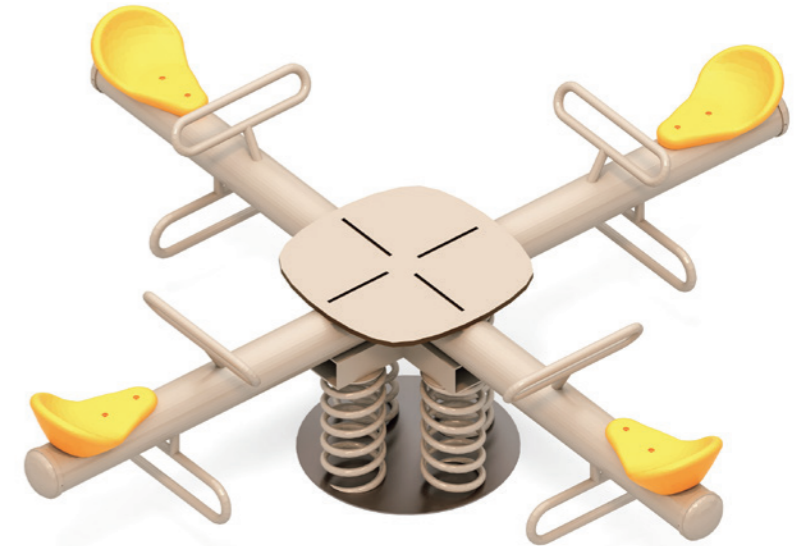

WISESAW - TRI
SR-21009

Ages: 2-5 & 5-12
Use Zone: 19' x 17'
Equipment Size: 6'10" x 6' x 2'4"



NEW
SEESAW
SR-21030

Ages: 2-5
Use Zone: 16' x 13'
Equipment Size: 8'8" x 1'5" x 2'2"

NEW
4-SEAT SEESAW (SILVER GRAY & LIME)
SR-21046

Ages: 2-5
Use Zone: 14' x 23'
Equipment Size: 12'10" x 1'5" x 2'5"

RIDER

Creative childish style, cute & eye-catching design.
Selected material, solid & durable.
Exercise children's vestibular balance, improve body coordination and sense of balance.

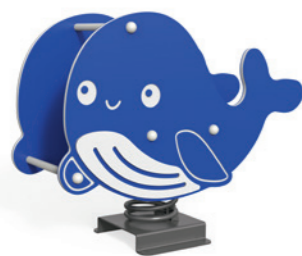

WHALE RIDER
SR-21020-114

Ages: 2-5
Use Zone: 14'x16'
Equipment Size: 1'4"x3'3"x2'6"

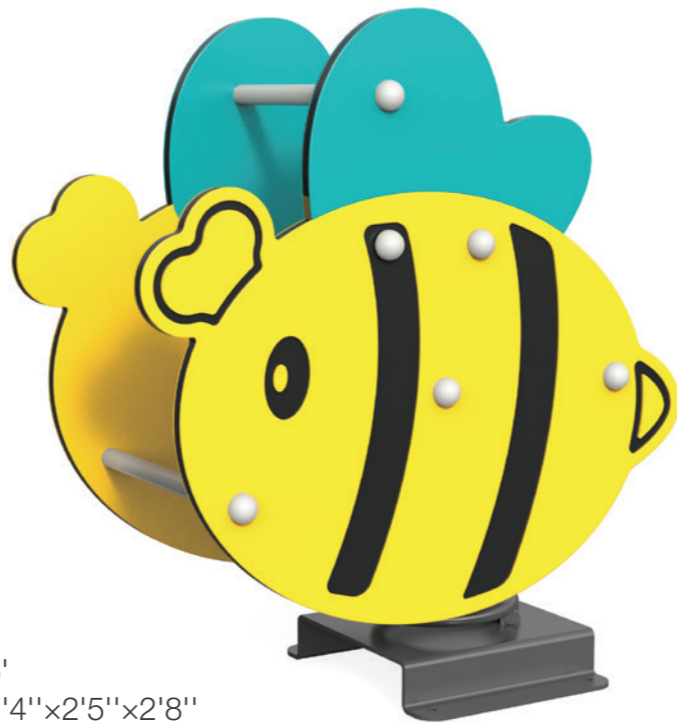

BEE RIDER
SR-21019-112

Ages: 2-5
Use Zone: 14'x15'
Equipment Size: 1'4"x2'5"x2'8"



2-SEAT SPACESHIP RIDER
SR-21025-10114

Ages: 2-5
Use Zone: 15'x15'
Equipment Size: 2'7"x2'11"x2'9"



ELEPHANT RIDER
SR-21022-131

Ages: 2-5
Use Zone: 14'x15'
Equipment Size: 1'4"x2'6"x2'8"

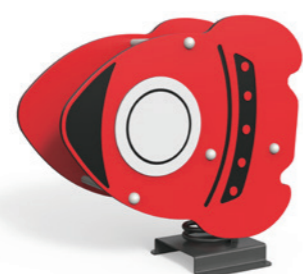

ROCKET RIDER
SR-21021-129

Ages: 2-5
Use Zone: 14'x15'
Equipment Size: 1'4"x2'9"x2'8"



PLANE RIDER
SR-21023-121

Ages: 2-5
Use Zone: 14'x15'
Equipment Size: 1'5"x2'11"x2'9"



2-SEAT BOAT RIDER
SR-21024-123

Ages: 2-5
Use Zone: 15'x15'
Equipment Size: 2'7"x3'x2'9"

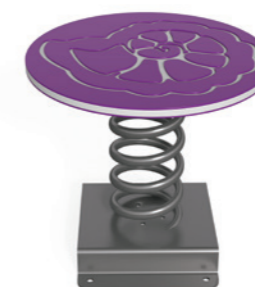

SPIRAL SHELL STANDING RIDER
SR-21028-77

Ages: 2-5
Use Zone: 16'x16'
Equipment Size: 1'8"x1'8"x1'6"



FISH STANDING RIDER
SR-21029

Ages: 2-5
Use Zone: 18'x18'
Equipment Size: 3'4"x3'4"x1'6"

TRAVEL RIDER
SR-21027-121123

Ages: 2-5
Use Zone: 16'x23'
Equipment Size: 3'6"x10'4"x3'

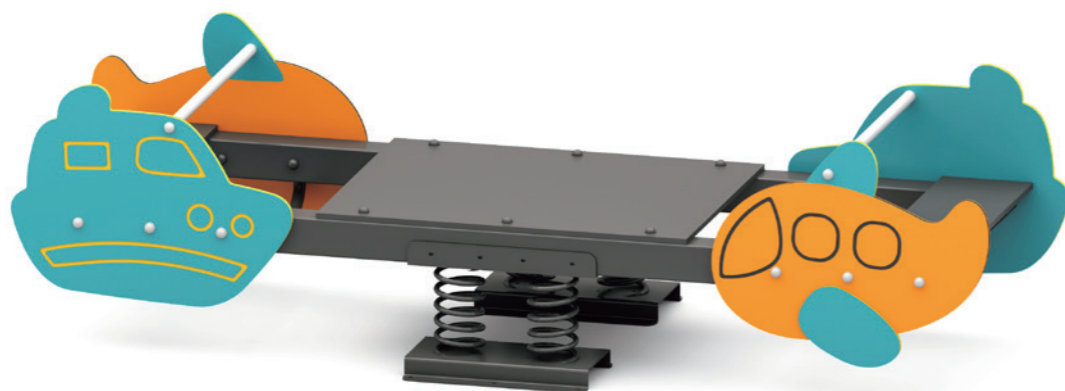

DINO RIDER
SR-21026-110

Ages: 2-5
Use Zone: 14'x23'
Equipment Size: 1'4"x10'4"x3'4"



WISE DIG
SR-21015-77121

Ages: 2-5
Equipment Size: 3'6"x1'x2'3"
Recommended for use with a 12" depth of loose-fill sand.



SINGLE POST SWING W/ SHADE

Number	Description	Use Zone
SPS-0801-SF-113	5" Single Post Swing w/ Shade 8ft-1 Bay	24'x32'
SPS-0802-SF-113	5" Single Post Swing w/ Shade 8ft-2 Bay	36'x32'
SPS-0803-SF-113	5" Single Post Swing w/ Shade 8ft-3 Bay	48'x32'
SPS-0804-SF-113	5" Single Post Swing w/ Shade 8ft-4 Bay	60'x32'
SS-0011	Full Bucket Seat & Galvanized Steel Chain Set	Sold Separately
SS-0012	Belt Seat & Galvanized Steel Chain Set	Sold Separately



FULL BUCKET SEAT



BELT SEAT



1FT GALVANIZED STEEL CHAIN



SINGLE CLEVIS CONNECTOR

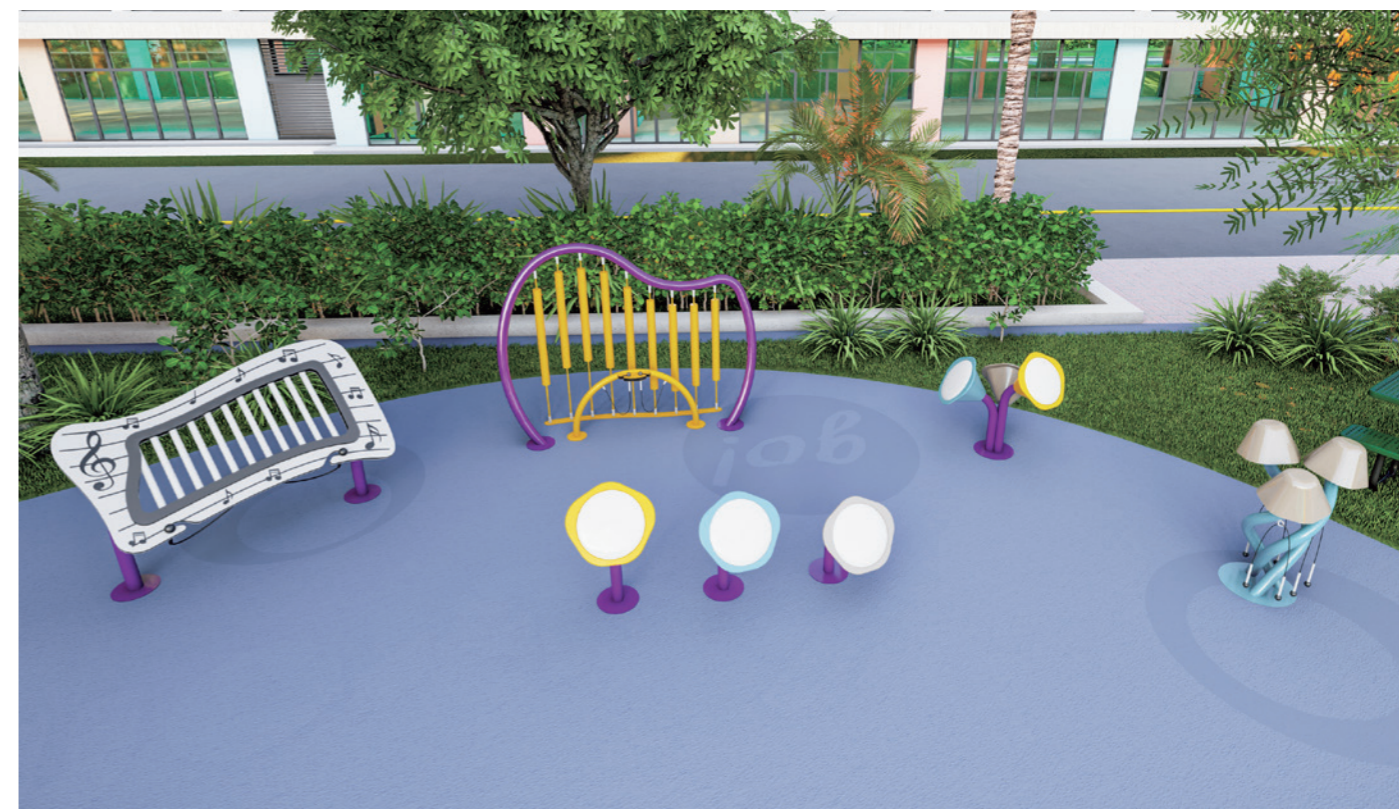

Freedom Flyer



Sapling Swing



**FREEDOM ARCH
FAS-35091D-DS**

Ages: 2-5 & 5-12
Use Zone: 26'x17'



**LITTLE BREEZE SWING
AS350800-MM**

Ages: 2-5 & 5-12
Use Zone: 20'x17'
Equipment Size: 7'7" x 4'1" x 8'



**BELT WALK
75-21031-110113**

Ages: 2-5 & 5-12
Use Zone: 16'x14'
Equipment Size: 3'10" x 1'8" x 5'4"

Number	Description
SS-036-110	Freedom Arch Swing Frame
SS-039-113	Freedom Flyer

Number	Description
AS-350800-110	Single Arch Swing Frame
SS-042-113	Sapling Swing



**NEW
SOUNDWAVE
72-21099**



**NEW
HARMONY RAIL
72-21100**



**NEW
TEMPO TULIPS
72-21102**



**NEW
PERCUSSION PALS
72-21101**



**NEW
BLOOM BEATS
72-21103**

NatureWISE

The NatureWISE series draws inspiration from the endless wonders of the natural world, bringing a touch of the outdoors to every play space. This collection features timeless wooden structures that offer the beloved "classic" playground look, blending seamlessly into any environment and enhancing the charm of your play area.

By combining the adventure and excitement of nature with the unmatched durability, safety, and low-maintenance features of high-quality play equipment, NatureWISE delivers the perfect harmony of style and functionality. These designs create an inviting space for endless hours of imaginative play, fostering creativity and exploration while standing the test of time.

- 211 NaturePLAY Theme
- 217 NatureCHALLENGE
- 221 NatureMAX Theme



www.wisdomplaygrounds.com

NaturePLAY Theme

NaturePLAY features storybook like woodland elements, that encourage children to use their imaginations for outdoor play. This offers children the ability to transport to their own magical forests full of adventures. NaturePLAY structures are built with 4" Pinewood posts, which allows the structure to be lighter, and more versatile.

The NaturePLAY series is the perfect solution for any community that is in need of a more physically challenging play structure, with a variety of nature-themed elements, that can also be customized.

All NatureWISE structures use high-end solid quality wood, which has its own anti-corrosion properties making it a strong and solid option, with quality guaranteed.



Round Pinewood Post



Round Pinewood



WPC Deck



NaturePLAY



ADA



TreeHouse



Nature



Castle



Pirate Ship



Scan above to learn more



GROW AND GO | B-C001

Ages: 5-12

Fall Height: 84"

Use Zone: 51'x50'

Equipment Size: 39'4"x35'11"x15'7"

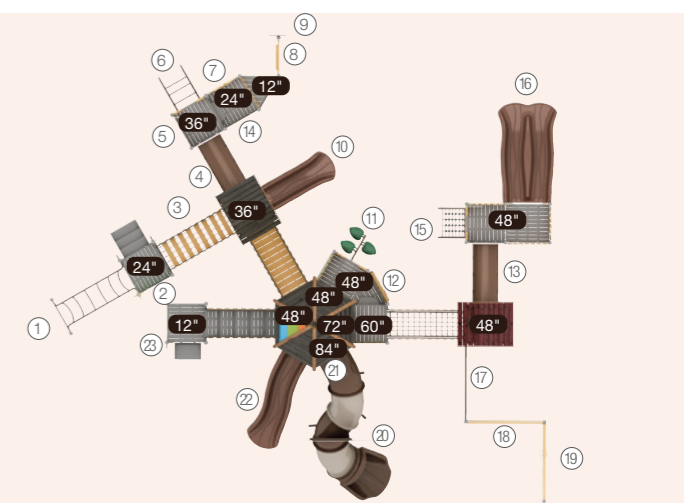

- ① Berlin - Invert Arch Ladder
- ② Balls & Flowers
- ③ Inclined Straight Bridge
- ④ Double Crawl Tunnel
- ⑤ Numbers & Letters Panel
- ⑥ 3ft Arch Climber
- ⑦ Cymbals Panel
- ⑧ Marimba Panel
- ⑨ Height Measure
- ⑩ 3ft Single Slide
- ⑪ 4ft Leaf Step Climber
- ⑫ Insect Panel
- ⑬ Inclined Crawl Tunnel
- ⑭ Food Match Panel
- ⑮ 3ft Net Climber
- ⑯ 4ft Double Slide
- ⑰ Net & Ladder Climbing
- ⑱ Single-log Bridge
- ⑲ Basic Hanging & Swining
- ⑳ 7ft S-shape Tube Slide Right Turn
- ㉑ Plant Panel
- ㉒ 4ft Single Slide
- ㉓ ADA Transfer Station





MIRKWOOD | B-C003A

Ages: 5-12
 Fall Height: 84"
 Use Zone: 44'x38'
 Equipment Size: 30'5" x 22'7" x 16'3"

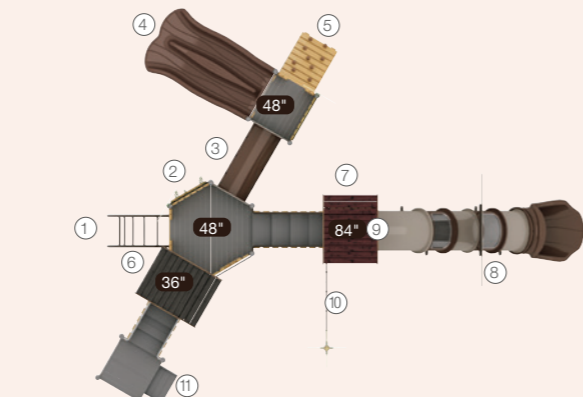

- ① 4ft Arch Climber
- ② Plant Panel
- ③ Double Crawl Tunnel
- ④ 4ft Double Slide
- ⑤ 4ft Wooden Panel Climber
- ⑥ Numbers & Letters Panel
- ⑦ Marimba Panel
- ⑧ 7ft Straight Tube Slide
- ⑨ Colorful Window Panel
- ⑩ Net Climbing
- ⑪ ADA Transfer Station

BERNWOOD B-C006A

Ages: 5-12
 Fall Height: 84"
 Use Zone: 35'x33'
 Equipment Size: 23'2" x 20'3" x 13'5"

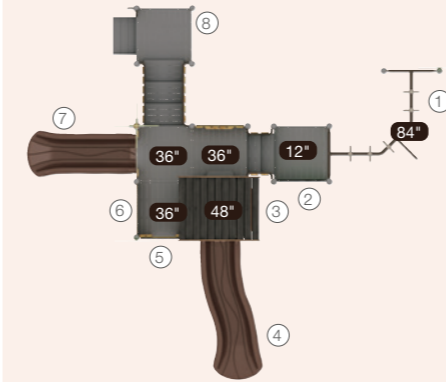

- ① 90° Overhead Swinging Rings
- ② Balls & Flowers
- ③ Counter Panel
- ④ 4ft Single Slide
- ⑤ 3ft Vertical Climber
- ⑥ Numbers & Letters Panel
- ⑦ 3ft Single Slide
- ⑧ ADA Transfer Station



BRISTLECONE B-C009A

Ages: 5-12
 Fall Height: 72"
 Use Zone: 38'x32'
 Equipment Size: 25'5" x 19'4" x 14'11"

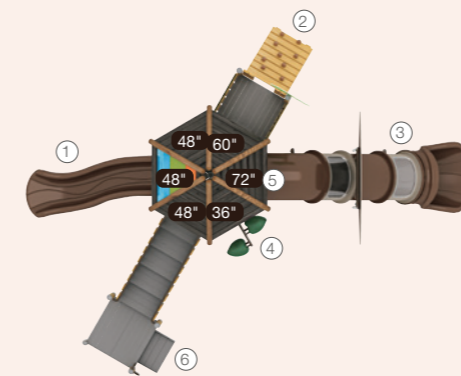

- ① 4ft Single Slide
- ② 4ft Wooden Panel Climber
- ③ 6ft Straight Tube Slide
- ④ 3ft Leaf Step Climber
- ⑤ Plant Panel
- ⑥ ADA Transfer Station



KNIGHTS PLAY

B-B008A

Ages: 5-12

Fall Height: 48"

Use Zone: 34'x32'

Equipment Size: 21'7"x19'10"x14'1"

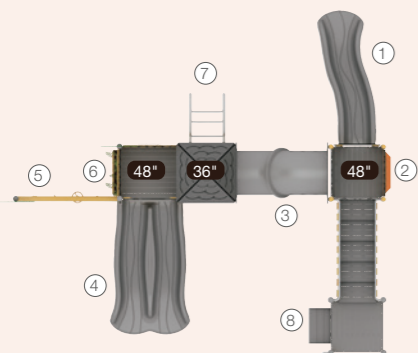

- ① 4ft Single Slide
- ② Counter Panel
- ③ Inclined Crawl Tunnel
- ④ 4ft Double Slide
- ⑤ Basic Hanging & Swinging
- ⑥ Plant Panel
- ⑦ 3ft Arch Climber
- ⑧ ADA Transfer Station

DANCING MOLLY

B-D004A

Ages: 2-5 & 5-12

Fall Height: 60"

Use Zone: 42'x35'

Equipment Size: 29'11"x22'8"x17'6"

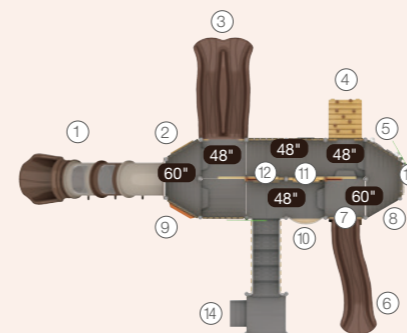

- ① 5ft Straight Tube Slide
- ② Kaleidoscope Panel
- ③ 4ft Double Slide
- ④ 4ft Wooden Panel Climber
- ⑤ Water Channel Panel
- ⑥ 5ft Single Slide
- ⑦ Sand Game Panel
- ⑧ Food Match Panel (Above)
- ⑨ Counter Panel (Below)
- ⑩ Colorful Window Panel
- ⑪ Bells Panel
- ⑫ Marimba Panel
- ⑬ Sand & Water Panel
- ⑭ ADA Transfer Station

ELTZ

B-B009A

Ages: 5-12

Fall Height: 48"

Use Zone: 37'x30'

Equipment Size: 25'3"x16'9"x16'3"

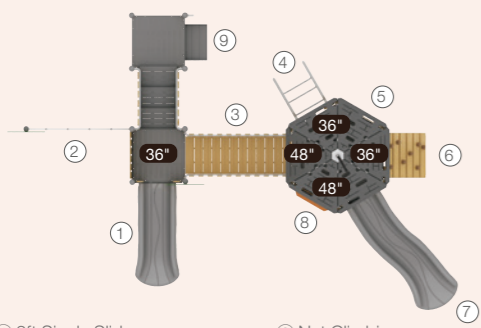

- ① 3ft Single Slide
- ② Net Climbing
- ③ Inclined Straight Bridge
- ④ 3ft Arch Climber
- ⑤ Numbers & Letters Panel
- ⑥ 3ft Wooden Panel Climber
- ⑦ 4ft Single Slide
- ⑧ Counter Panel
- ⑨ ADA Transfer Station

SLOOP

B-D006A

Ages: 5-12

Fall Height: 84"

Use Zone: 39'x33'

Equipment Size: 27'10"x20'4"x17'5"

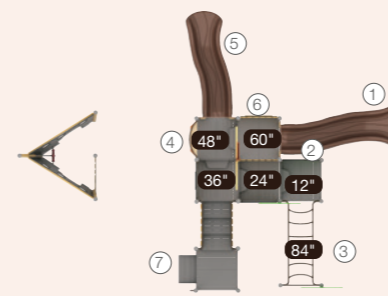
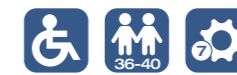

- ① 5ft Single Slide
- ② Balls & Flowers
- ③ Invert Arch Ladder
- ④ Counter Panel
- ④ 4ft Single Slide
- ⑥ Cymbals Panel
- ⑦ ADA Transfer Station

NatureCHALLENGE

Wisdom's NatureCHALLENGE series is the perfect solution for any community that is in need of a more physically challenging play structure, with a variety of nature-themed elements, that can also be customized.

The NatureCHALLENGE series integrates large-scale comprehensive equipment and a elements of sensory play that help children to develop their physical abilities. This supports children to explore their surroundings more autonomously while using a wide range of activities. It also promotes the development of children's gross motor abilities and sensory processing.

All NatureWISE structures use high-end wood, which has its own anti-corrosion properties making it a strong and solid option with quality guaranteed. Wisdom's NatureWISE Series promotes the development of multiple skills in children through physical exercise.



Pinewood



Robinia Deck



Robinia Deck

Scan



Scan above to learn more



TreeHouse



Pirate Ship



Nature



HANGING+BALANCING+CLIMBING

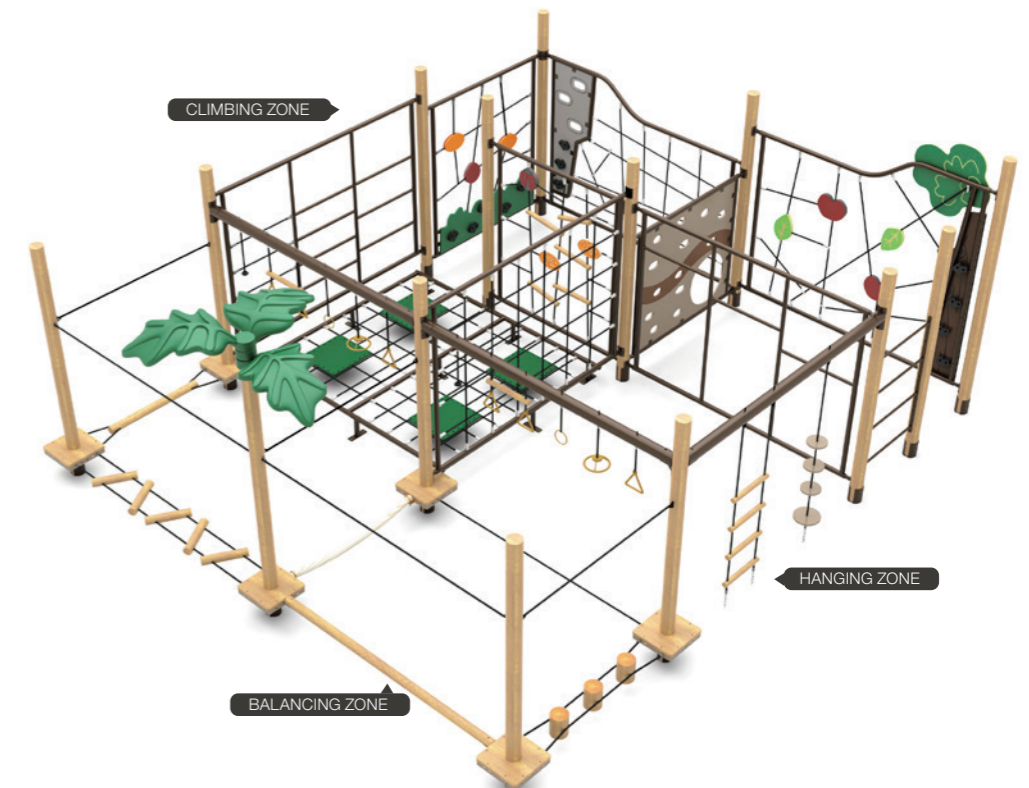
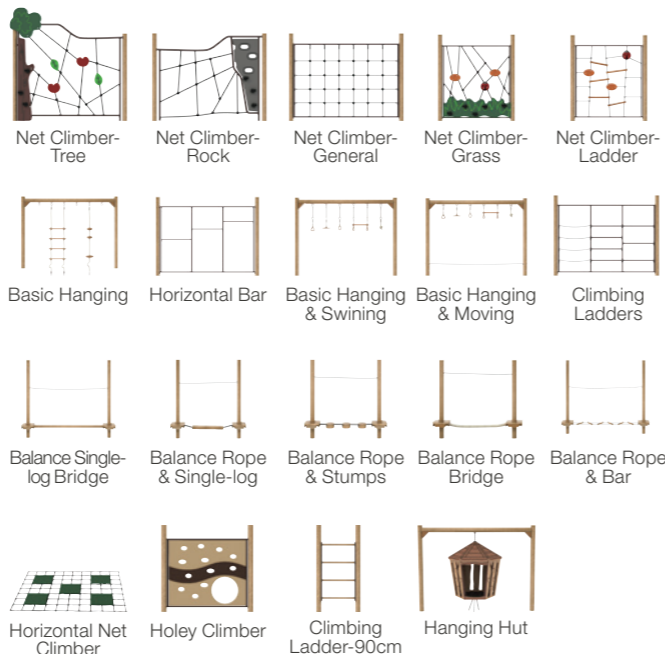

HIKER'S HIDEOUT HW1-S291-VA

Ages: 5-12

Fall Height: 82"

Use Zone: 34' x 31'

www.wisdomplaygrounds.com



HAWAIIAN HUT HW1-S289-VA

Ages: 5-12
Fall Height: 60"
Use Zone: 31'x47'
Equipment Size: 11'4"x26'1"x14'6"

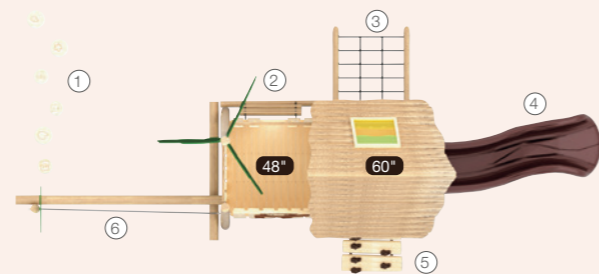

- ① Balance Stumps
- ② Rung Climber
- ③ Net Climber
- ④ 5ft Single Slide
- ⑤ Rock Climber
- ⑥ Single-log Bridge



16-18



CHUCK HW1-S286-VA

Ages: 2-5
Fall Height: 24"
Use Zone: 23'x23'



ELLA HW1-S287-VA

Ages: 2-5
Fall Height: 24"
Use Zone: 15'x24'



HAL HW1-S288-VA

Ages: 2-5
Fall Height: 24"
Use Zone: 23'x27'

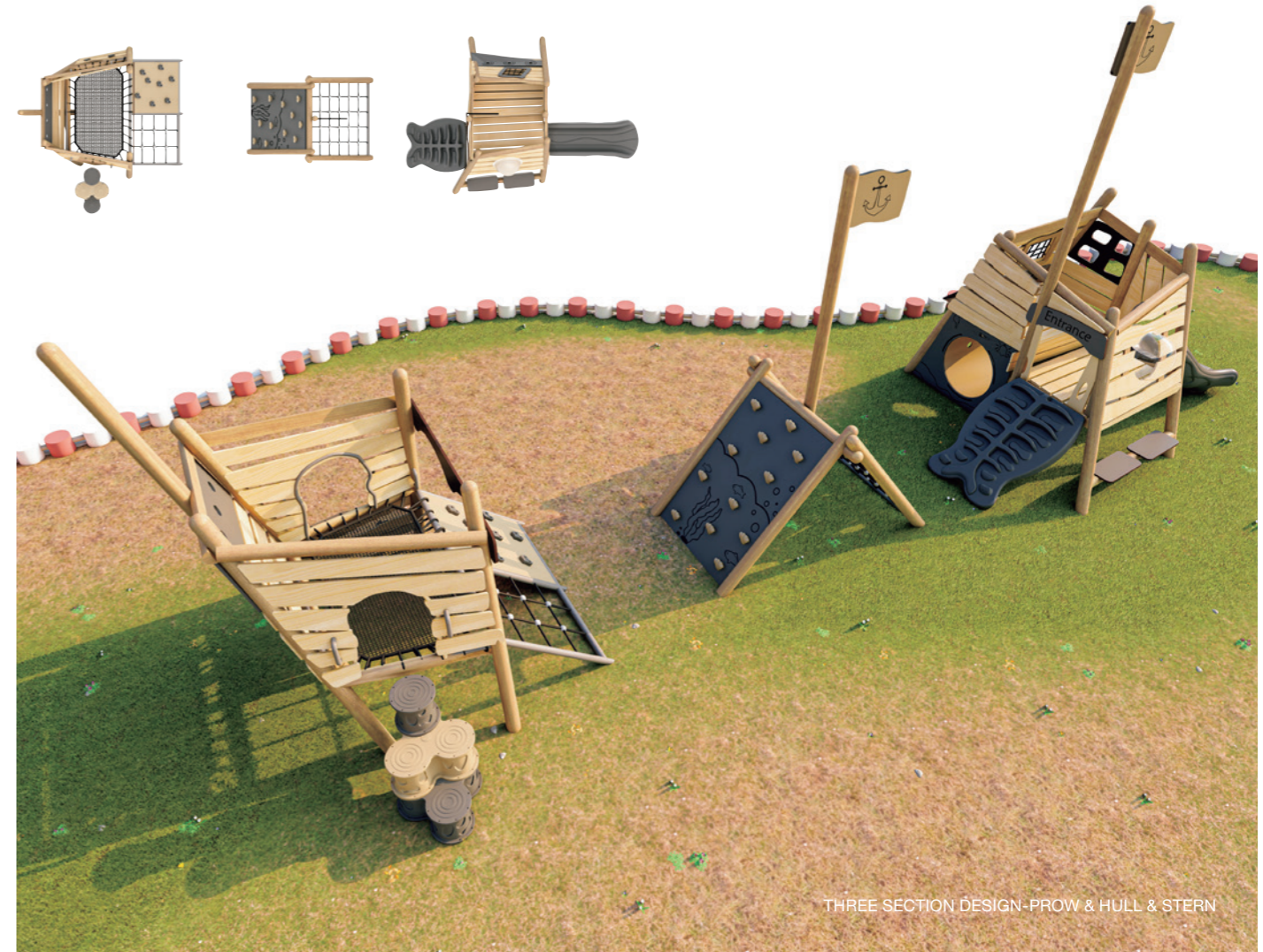

THREE SECTION DESIGN-PROW & HULL & STERN

NatureMAX Theme

The NatureMAX Theme is designed for all elements of fun. Climbers, slides, and movable elements paired with multiple themes provide endless options for entertainment. Wood style elements make these sets stand out in any environment, with a variety of nature-themed elements, you can customize.

The NatureMAX series supports children in exploring their surroundings more autonomously while using a wide range of activities. It also promotes the development of multiple skills in children through physical exercise.

All NatureMAX structures use high-end wood, which has its own anti-corrosion properties making it a solid and strong option. Wisdom's NatureMAX series promotes the development of multiple physical qualities of children through physical exercise. NatureMAX structures are built with 5" posts which allows the structure to be sturdy with more versatility.



Pinewood



Robinia Deck



Robinia Deck



NatureMAX



Nature



Castle



TreeHouse



Pirate Ship

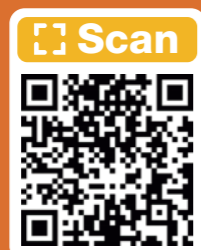

Scan above to learn more



NATURE CASTLE F-A001A2

Ages: 5-12

Fall Height: 132"

Use Zone: 58'x49'

Equipment Size: 46'x33'6"x24'

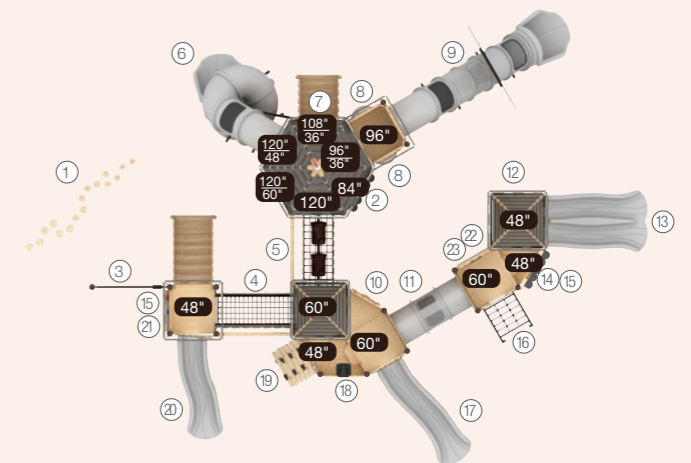

- ① Balance Stumps
- ② Counter Pane
- ③ Net Climber-Rock
- ④ Arch Net Bridge
- ⑤ Inclined Trunk Link
- ⑥ 10ft Spiral Tube Slide Left Turn
- ⑦ Growth Ring & Clock Panel
- ⑧ Bubble Window Panel
- ⑨ 8ft Straight Tube Slide
- ⑩ Kitchen Panel
- ⑪ Triple Crawl Tunnel
- ⑫ Train Gear Panel
- ⑬ 4ft Double Slide
- ⑭ Car Panel
- ⑮ Cannon Panel
- ⑯ 5ft Single Slide
- ⑰ 4ft Single Slide
- ⑱ 4ft Robinia Rock Climber
- ⑲ 4ft Single Slide
- ⑳ Drums Panel
- ㉑ Tic-Tac-Toe Panel
- ㉒ Crocodile Puzzle Panel



MONTCLAIR F-A002A

Ages: 5-12
Fall Height: 60"
Use Zone: 43'x33'
Equipment Size: 30'4"x20'2"x18'

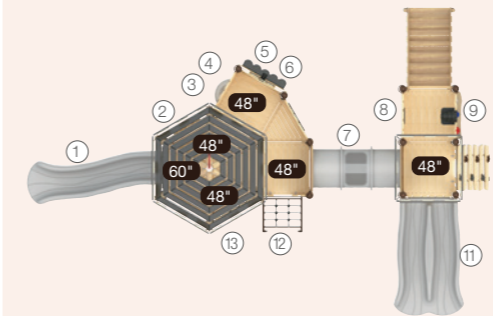

- ① 5ft Single Slide
- ② Growth Ring & Clock Panel
- ③ Tic-Tac-Toe Panel (Below)
- ④ Bubble Window Panel (Above)
- ⑤ Driving Panel (Below)
- ⑥ Cannon Panel (Above)
- ⑦ 62" Crawl Tunnel
- ⑧ Crocodile Puzzle Panel
- ⑨ Telescope Panel
- ⑩ 4ft Rock Climber
- ⑪ 4ft Double Slide
- ⑫ 4ft Net Climber
- ⑬ Harp Panel



HOT PORTER | F-A009A2

Ages: 2-5
Fall Height: 48"
Use Zone: 41'x37'
Equipment Size: 28'2"x24'7"x17'

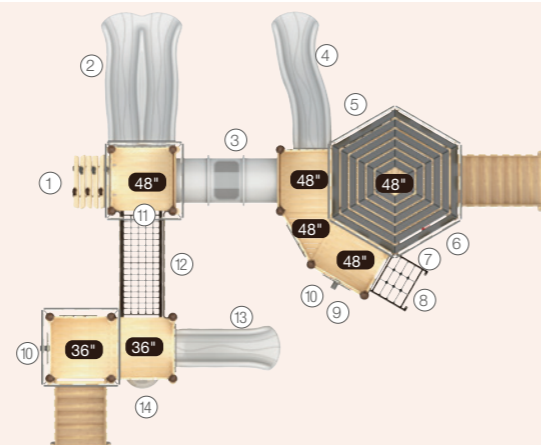

- ① 4ft Rock Climber
- ② 4ft Double Slide
- ③ 62" Crawl Tunnel
- ④ 4ft Single Slide
- ⑤ Harp Panel
- ⑥ Tic-Tac-Toe Panel (Below)
- ⑦ Growth Ring & Clock Panel (Above)
- ⑧ Counter Panel (Below)
- ⑨ 4ft Net Climber (Above)
- ⑩ Driving Panel (Below)
- ⑪ Drums Panel
- ⑫ Arch Net Bridge w/Metal Barrier
- ⑬ 3ft Single Slide
- ⑭ Bubble Window Panel

CORVIN F-A003A2

Ages: Ages: 2-5 & 5-12
Fall Height: 48"
Use Zone: 39'x28'
Equipment Size: 26'3"x15'2"x15'9"

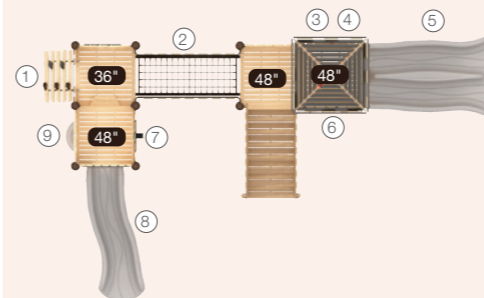

- ① 3ft Rock Climber
- ② Arch Net Bridge w/Metal Barrier
- ③ Tic-Tac-Toe Panel (Below)
- ④ Growth Ring & Clock Panel (Above)
- ⑤ 4ft Double Slide
- ⑥ Drums Panel
- ⑦ Cannon Panel
- ⑧ 4ft Single Slide
- ⑨ Bubble Window Panel



MOUNTAINEER F-C003A1

Ages: 2-5
Fall Height: 48"
Use Zone: 40'x28'
Equipment Size: 28'x15'4"x14'

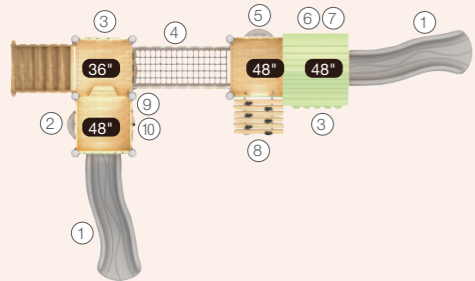

- ① 4ft Single Slide
- ② Bubble Window Panel
- ③ Car Panel
- ④ Arch Net Bridge
- ⑤ Cannon Panel
- ⑥ Train Gear Panel
- ⑦ Crocodile Puzzle Panel
- ⑧ 4ft Robinia Rock Climber
- ⑨ Growth Ring & Clock Panel (Above)
- ⑩ Drums Panel (Below)

NEPTUNE F-B005A2

Ages: 5-12
Fall Height: 60"
Use Zone: 41'x40'
Equipment Size: 28'3"x27'1"x18'7"

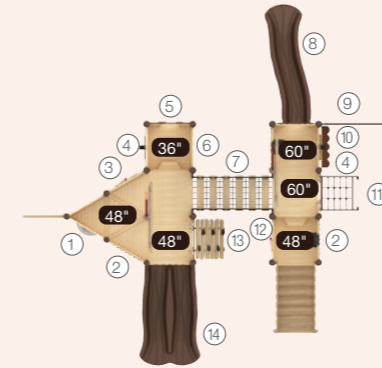

- ① Bubble Window Panel
- ② Marimba Panel
- ③ Growth Ring & Clock Panel
- ④ Cannon Panel
- ⑤ 3ft Vertical Rock Climber
- ⑥ Crocodile Puzzle Panel
- ⑦ Inclined Step Board Bridge
- ⑧ 5ft Single Slide
- ⑨ Net Climber-General
- ⑩ Counter Panel
- ⑪ 5ft Net Climber
- ⑫ Train Gear Panel
- ⑬ 4ft Robinia Rock Climber
- ⑭ 4ft Double Slide

GLACIER EXPRESS F-C004A1

Ages: 5-12
Fall Height: 60"
Use Zone: 33'x27'
Equipment Size: 20'3"x13'3"x14'7"

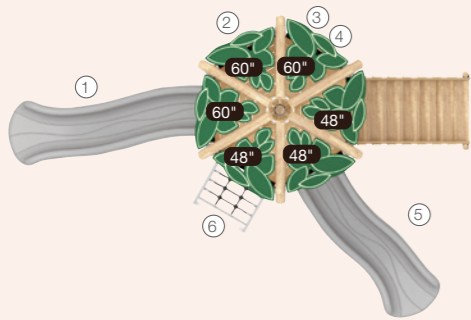

- ① 5ft Single Slide
- ② Train Gear Panel
- ③ Crocodile Puzzle Panel (Above)
- ④ Kitchen Panel (Below)
- ⑤ 4ft Single Slide
- ⑥ 4ft Net Climber

NOTORIOUS F-B006A2

Ages: 5-12
Fall Height: 48"
Use Zone: 31'x31'
Equipment Size: 18'10"x18'2"x17'7"

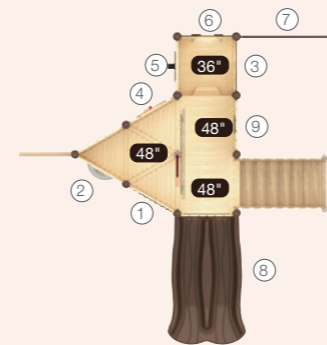

- ① Marimba Panel
- ② Bubble Window Panel
- ③ Crocodile Puzzle Panel
- ④ Growth Ring & Clock Panel
- ⑤ Cannon Panel
- ⑥ 3ft Vertical Rock Climber
- ⑦ Net Climber-General
- ⑧ 4ft Double Slide
- ⑨ Crocodile Puzzle Panel

Component List

SLIDES



WP WM U

3ft-5ft Single Slide



WP WM U

4ft-5ft Double Slide



WP WM U

3ft-8ft Sectional Slide



WP WM U

5ft Sectional Slide 45° Right Turn



WP WM U

5ft-7ft Triple Sectional Split Slide



WT WP WM U

360° Spiral Slide



WP WM U

5ft-10ft L-shape Tube Slide



WP WM U

7ft-10ft S-shape Tube Slide



WP WM U

3ft-10ft Straight Tube Slide



WP WM U

8ft-10ft Spiral Tube Slide



WT

2ft Single Slide



WP WM WT

2ft Inclined Crawl Tunnel Section Right Turn



NEW WP WM U

S-shape Tube Slide Left Turn w/Open Exit Chute

OVERHEAD CLIMBERS



WP U

90° Overhead Swing Rings



WP U

Zig Zag Overhead Rings



WP U

Invert Arch Ladder



WP U

Deck to ground Whirler



WP WM U

Deck to ground Challenge Ladder

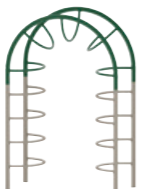

Up & Over Climber



Double Up & Over Climber

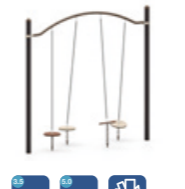

WP WM U

Toadstool Climber



WP WM U

Clover Step Bridge



WP WM U

Jumbo Round Stepper



WP WM U

Freestanding Whirler



WP WM U

Horizontal Loop Ladder



WP WM U

Horizontal Lollipop Ladder



WP WM

Round about Challenge



WP WM U

Lilly Pad Walk



WM U

Overhead Wavy Challenge Ladder



WP

Steps & Ropes Bridge



WM U

90° Overhead Rings



WM U

90° Clover Steps Bridge



WM U

Overhead Power Challenge Ladder



WP

Rings & Ropes Bridge



WP

Horizontal Curved Challenge - Clover Steps & Balls Bridge



WP WM

Track Ride 136" Straight



WM U

U-shape Overhead Challenge Ladder



WP

Two-post Clover Steps & Balls Bridge



WM U

Round Horizontal Ladder



WM U

270° Overhead Challenge Ladder

CLIMBERS



WP WM U

3ft-8ft Ribbon Climber



WP WM U

3ft-8ft Snake Climber

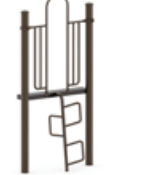

WP WM U

3ft-8ft Wing Climber



WP WM U

3ft-5ft Arch Climber



WP WM U

4ft-6ft Stair Climber



WP WM U

4ft-6ft Leaf Climber



WP WM U

3ft-6ft Leaf Step



WP WM U

4ft-6ft Climbing Arc



WP WM U

3ft-5ft Qubest Climber Entry



WP U

Deck to ground Whirler



WP WM U

Deck to ground Challenge Ladder

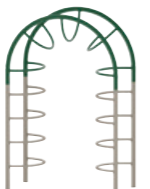

Up & Over Climber



Double Up & Over Climber

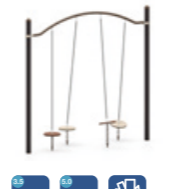

WP WM U

Toadstool Climber



WP WM U

Clover Step Bridge



WP WM U

4ft-6ft GEO Vertical Climber



WP WM U

2ft-5ft Net Climber



WP WM U

4ft Stump Climber



WP WM U

3ft-6ft Pod Climber



WP WM U

1ft-5ft Trunk Climber



WP WM WT U

2ft/3ft Fish Climber



WP WM U

3ft-5ft Wave Climber



WP WM U

4ft/5ft Rock Climber



WP WM U

2ft-4ft PE Starfish Rock Climber



WP WM U

2ft-4ft Tree wall Climber



WP WM U

2ft-4ft Step and Stone Climber



WP WM U

2ft-6ft Rockwall



3ft/4ft Clover Steps 4ft/5ft Arch O-Zone Climber 3ft Rope Ladder 2ft/3ft Arch Grab Climber 2ft/3ft Belt Climber 2ft-4ft Sail Climber 2ft Walk the plank Climber 2ft Stump Steps Deck to Deck Vertical Link Deck to Deck Straight Link Deck to Deck Arch Rock Climber 5ft Hemisphere Climber



1ft/2ft WiseTOT Step 1ft WiseTOT Ramp Crescent Climber Climbing Arc Tri-Crawl Panel Arch leaf Climber 7ft Stanley the Spider Power Frame Climber PE Upright Rocker Climber Upright Net Climber Height: 2ft/3ft Upright Net Crawl Tunnel 1-Unit Rope Game



Honeycomb Arch Climber Sail Rock panel 3ft-5ft PE Rock Climber 3ft-5ft Frog hop Vertical Climber Arch Climbing Panel Vertical O-zone Climber Upright Climbing Rope Tunnel Height:3ft-6ft 120cm Spiral Climber Net Deck w/1-Hole 2ft Deck Slope C-shape Rope Tunnel Height:4ft/5ft Bay Window

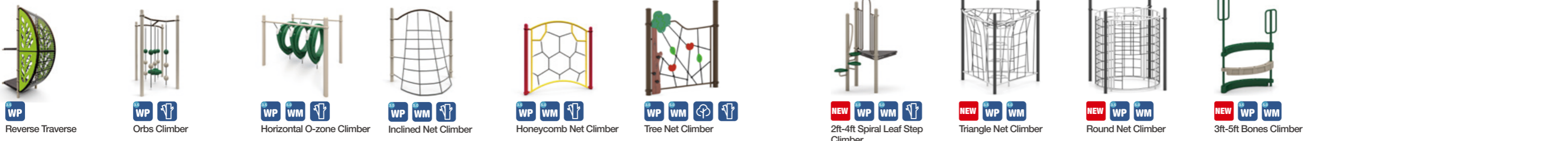

Reverse Traverse Orbs Climber Horizontal O-zone Climber Inclined Net Climber Honeycomb Net Climber Tree Net Climber 2ft-4ft Spiral Leaf Step Climber Triangle Net Climber Round Net Climber 3ft-5ft Bones Climber



Giraffe Net Climber Jungle Net Climber Rock Net Climber Ladybug Net Climber Ladybug Ladder Climber Net Climber

BRIDGES



Arch Net Bridge 8' Arch Net Bridge w/Metal Barrier 6' Arch Net Bridge w/Rock Grain Barrier Power Rungs 72" Rope & Rung Balance S Balance Bridge Rung Challenge Climber Power Rungs 48" 3ft-6ft Fireman's Pole 6' Arch Net Bridge w/Wood Grain Barrier Trunk Link w/Metal Barrier Plank Board Bridge 6' Arch Plank board w/Rock Grain 6' Step Board Bridge w/Wood Grain Barrier Step Board Bridge w/Net Barrier



WP 90° Cloud Plank
 WP WM Trunk Link w/Handrail
 WP WM Trunk Link w/Metal Barrier
 WP WM Straight Bridge w/Handrail
 WP Straight Bridge w/Wood Grain Barrier
 WP Straight Bridge w/Metal Barrier



WP WM Arch Bridge
 WP WM Straight Bridge
 WP WM 1ft Straight Bridge w/Metal Barrier
 WP WM 1ft Inclined Straight Bridge w/Metal Barrier
 WP Net Bridge
 WM Inclined Elastic Bridge w/Net Barrier



WM Single Log Balance Bridge w/Handrails
 WM O-zone Bridge
 WT Arch Bridge w/o Handrails
 WM Clover Stairs
 WM Inclined V-shape Belt Bridge w/Overhead Rings
 WM Inclined O-zone Bridge w/Clover Climber



WP Belt Bridge w/Handrails
 WP Belt Steps Bridge w/Handrails
 WP Inclined Elastic Bridge
 WP WM Crawl Tunnel
 WP WM S Shape Crawl Tunnel
 WP WM Curved Crawl Tunnel



WP WM 1ft Inclined Crawl Tunnel
 WP WM S-shape Rope Tunnel
 WP Net Crawl Tunnel
 WP WM Inclined Crawl Tunnel length:80/160/8ft
 NEW WP WM 12" Inclined Clover Steps w/Handrail L100"
 NEW WP WM 24" Inclined Step Board Bridge w/Handrails L100"



NEW WP WM ADA Ramp w/Play Panels
 NEW WP WM 24" Inclined Twist Challenge Crawl Tunnel
 NEW WP WM 12" Inclined Twist Challenge Crawl Tunnel
 NEW WP WM Duo Twist Challenge Crawl Tunnel

PANELS



WP Safety Panel
 WP Panel for Large Activity Insert
 WP Panel for Small Activity Insert



WP Panel for Large Square Activity Insert
 WP WM Single Slide Hood
 WP WM Double Slide Hood
 WP Triple Slide Hood
 WP Counter Panel
 WP Castle theme - Panel for Large Square Activity Insert

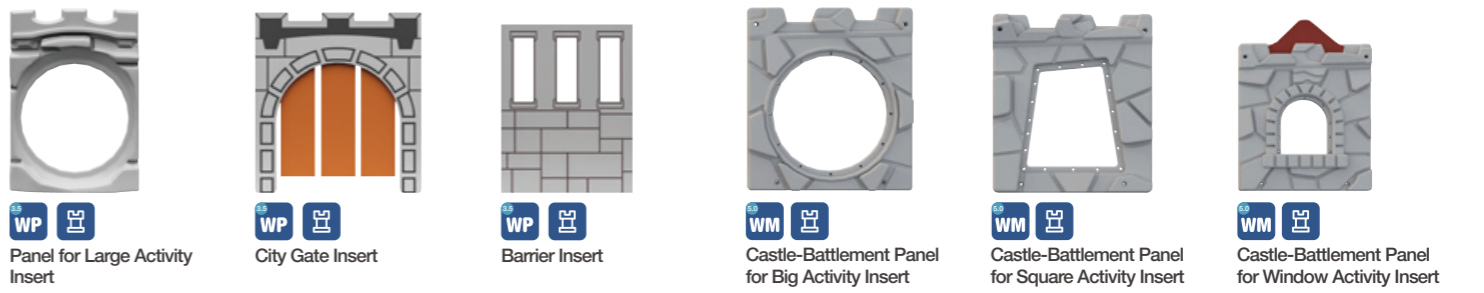

WP Panel for Large Activity Insert
 WP City Gate Insert
 WP Barrier Insert
 WM Castle-Battlement Panel for Big Activity Insert
 WM Castle-Battlement Panel for Square Activity Insert
 WM Castle-Battlement Panel for Window Activity Insert



WM Castle-Battlement Panel w/Rock
 WM Castle-Battlement Panel w/Rock
 WP Treehouse - Barrier Insert
 WP TreeHouse Counter Panel
 WP TreeHouse Snail Panel
 WM Treehouse-Panel for Small Active Insert



WM Treehouse-Panel for Square Activity Insert
 WM Panel for Large Activity Insert (Tan)
 WM Treehouse - PE Tube Slide Hood
 WM Tree Hole Entry
 WP Corsair Doorway Panel (Brown)
 WP Corsair Panel for Large Activity Insert (Tan)



WP Boston - Corsair Barrier Panel (Brown)
 WP Boston - Corsair Entry Panel
 WP Boston - Corsair Counter Panel
 WP Boston - Corsair Prow Panel (Brown)
 WP Rooftop Flag
 WP Boston - Corsair Sail



WP
Decorative Panel (Shark)



WM
Ship bow



WM
Corsair - Panel for Large Activity Insert



WM
Corsair-Panel for Small Activity Insert



WM
Corsair-Panel for Square Activity Insert

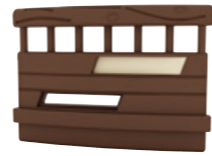

WM
Starboard Panel



WM
Port Window Panel



WM
Ship Tube Slide hood



WM
Ship Compass Worktop

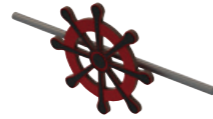

WM
Ship Helm



WM
Ship Wave Panel



WM
Ship Flag



WP
Balcony Deck Barrier w/
Steering Wheel



WP
Galaxy panel



WT
WiseTOT Elephant Panel



WT
PE Tri-window Panel



WT
PE Hole Panel



WT
Safety Panel



WP
Floor-to-ceiling Bay Window



WP
Bay Window w/Barrier



WP
Drawing Panel - Autumn Tree



WP
Drawing Panel - Blue Leaf



WM
Insect & Spider Panel



WP
Twist - A - Tile Panel



WM
Castle Entry Panel



WM
Fish Entry Panel



WM
Window Panel



WP
Gate Panel



WP
Wave Panel



WM
Ship - Barrel panel
The retro barrel-shaped decoration facilitates role-playing activities such as "product sales," enhancing social interaction and language expression skills.



WM
Cottage Panel
Use the small blackboard to label product information, simulate sales scenarios, and engage in role-playing games that exercise language expression and social interaction.



WM
Drums Panel
Tapping to distinguish sounds explores differences in timbre and pitch, cultivates musical rhythm perception, and simultaneously trains hand-eye coordination.



WM
Kitchen Panel
Designed with stove and flame elements to simulate cooking scenarios, allowing children to play the role of "little chef" and practice language expression and social interaction.



WM
Driver Half Panel
Simulating a car dashboard with functional labels allows children to role-play as "little driver," exploring interactive component logic while learning basic mechanical and transportation knowledge.



WP
Sensory Red Window Worx
Perceiving color variations in light and shadow improves visual sensitivity and aesthetic awareness.



WP
Sensory Yellow Window Worx
Bright color combinations with star and geometric shapes boost visual sensitivity and aesthetic awareness.



WP
Sensory Green Window Worx
Green-toned crocodiles and geometric shapes, combined with light and shadow effects, foster color perception and visual sensitivity.

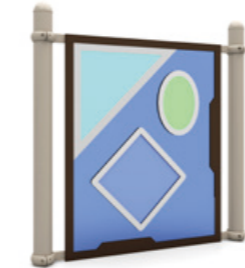

WP
Sensory Blue Window Worx
A blue color scheme paired with simple geometric patterns enhances visual sensitivity and aesthetic awareness.



WM
Atlanta - Train Game Panel
The retro locomotive design enables role-playing as "little train driver", encouraging interactive games such as "cargo transportation." Simulating in-train dining sales scenarios, elements like hamburgers and coffee add interactive fun for immersive role-playing experiences.



WP
PE Leaf Theme Music Panel
Tap to identify sounds and explore differences in timbre and pitch, enhancing auditory sensitivity and cultivating musical perception.



WP

PE Leaf Theme - Safety Panel

The clear, natural leaf-green leaf design brings the wonders of nature into the play area, fostering aesthetic awareness.



WP

Alto Panel

Strike the keys to explore differences in timbre and pitch, create simple melodies, and develop foundational music cognition.



WT

Bubble Window Panel

The convex surface of the bubble mirror creates a fun, distorted visual experience, introducing the scientific concept of optical reflection.



WT

PE Duo-window Panel

Through yellow and green transparent lenses, perceive the magical visual changes brought by light reflection or color overlay.



WP

Trunk Panel

Gently flick the bird to watch it nod playfully and accurately peck up a worm! This fun interaction enhances hand-eye coordination.



WP WM

Tic-Tac-Toe Panel

Arrange and combine symbols to form matching rows, columns, or diagonals, fostering logical and strategic thinking.

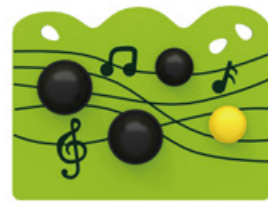

WT

WiseTOT Music Panel

Fun rhythm tapping explores differences in timbre and pitch, cultivates musical rhythm perception, and simultaneously improves hand-eye coordination.



WT

WiseTOT Turntable Panel

The steering wheel dial enhances hand-eye coordination, while sliding the orange dial to observe dynamic pattern changes trains visual tracking skills.



WT

WiseTOT Arch Panel

One side involves grasping and moving to simulate a bee collecting honey, while the other side simulates a rocket launch, helping to understand the concept of spatial displacement.



WT

WiseTOT Safety Panel

Grasping, moving, and mimicking the flight path of a butterfly helps children understand the concept of spatial displacement.

THEME PANELS



WT

PE Tic-tac-toe Panel

Arrange and combine symbols to form matching rows, columns, or diagonals, fostering logical and strategic thinking.



WT

PE Numbers & Shapes Panel

Introduces early mathematical concepts (numbers, counting) and shape recognition (circle, triangle, square) for educational enlightenment.



WT

PE Counter Panel

Open-ended "small window" encourage role-playing as shopkeepers or cottage owners, fostering social and expressive skills.



WT

WiseTOT Height Measurer Panel

Dual-unit scales marked in feet (Ft) and centimeters (cm) help toddlers recognize length units and develop self-awareness.



WP WM

Castle - Square Knight Insert



WP WM

Castle - Square Shield Insert



WP WM

Castle - Corsair Window Insert



WP WM

Castle - Safety Panel (Green)



WP WM

Castle - Safety Panel (Red)



WP WM

Castle - Square Window Insert



WP WM

Crocodile Puzzle Insert



WP WM

Sea Turtle Insert



WP WM

Barrier Insert



WP WM

Treehouse-Hut Insert



WP WM

Treehouse -Trunk Insert



WP WM

Castle-Window Insert



WM

Octopus & Starfish Panel

Elements such as octopuses, starfish, colorful fish, and jellyfish create a magical undersea world scene.



WP

Food Match Panel

Slide the honey stick along the track to understand motion paths and spatial displacement, presented in a lively, child-friendly style.



WP WM

Castle-Shield Insert

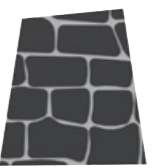

WP WM

Castle-City Wall Insert

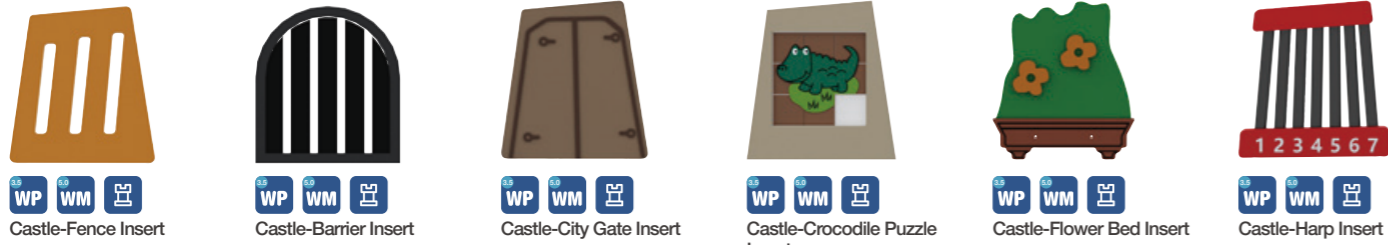

Castle-Fence Insert WP WM
Castle-Barrier Insert WP WM
Castle-City Gate Insert WP WM
Castle-Crocodile Puzzle Insert WP WM
Castle-Flower Bed Insert WP WM
Castle-Harp Insert WP WM

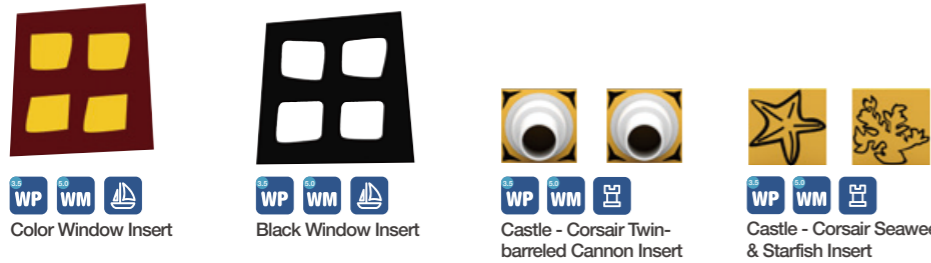

Color Window Insert WP WM
Black Window Insert WP WM
Castle - Corsair Twin-barreled Cannon Insert WP WM
Castle - Corsair Seaweed & Starfish Insert WP WM

ACTIVITY PANELS



Mind Maze WP WM
 As it rotates, a visual focal point gradually forms, allowing observation of dynamic pattern changes and enhancing visual tracking skills and sensitivity.
Vortex Effects Panel WP WM
 Rotate the handle to observe visual differences in vortex patterns, improving observation skills and visual concentration.
Moving Balls Panel WP WM
 Explore the motion patterns of rolling balls on different paths, introducing basic concepts of "mechanical movement."
Visual Turnplate Panel WP WM
 Rotate the dial to observe dynamic changes in colors and patterns. The vibrant, eye-catching surface stimulates curiosity and exploration.

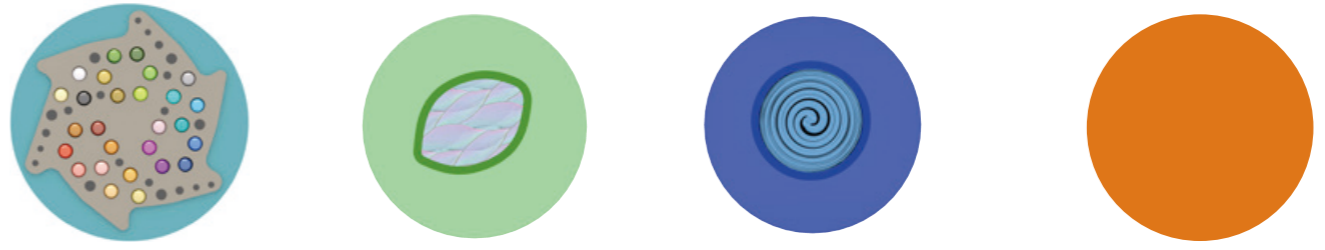

Tactile Balls Panel WP WM
 Both sides feature movable colored beads that provide rich tactile feedback through sliding and flicking, enhancing fine motor skills.
Green Leaf Window Insert WP WM
Blue Vortex Window Insert WP WM
Clear Window Insert WP WM



Big Window Insert WP WM
Bubble Window Insert WP WM



Treasure Hunt Insert WP WM
 Rotate the panel to lock onto a target treasure, then rely on memory and observation to find its match among the equipment decorations, systematically honing keen insight and spatial thinking.
Jungle Hunt insert WP WM
 Rotate the dial to lock onto a "target animal", then use memory and observation to locate its match in the play equipment decorations, systematically enhancing sharp observation and spatial thinking skills.
Clock Insert WP WM
 The front side features a clearly marked clock, while the back is decorated with a "bird announcing the time" pattern to attract active exploration and foster early time recognition.
Sand Clock Insert WP WM
 Compare how the speed of falling sand changes at different rotation rates, introducing basic physics concepts such as gravity and centrifugal force.



Beads & Cups Insert WP WM
 Introducing mathematical concepts such as "scales" and "capacity" helps cultivate early mathematical thinking and logical reasoning.
Maze Insert WP WM
 By tracking the trajectory of rolling beads, children can understand spatial displacement and easily recognize various symbols such as "\$" and "+".

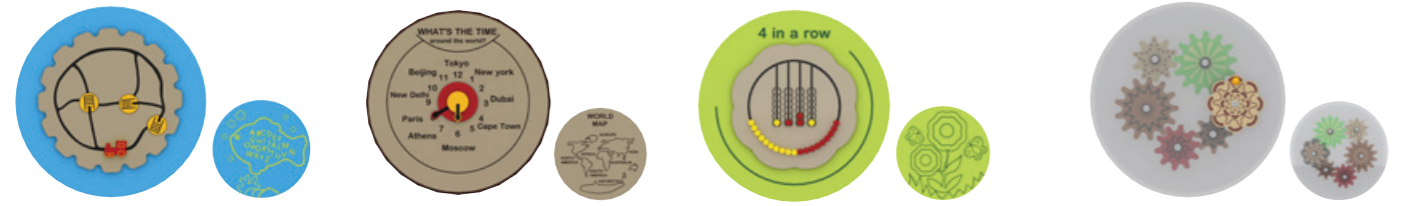

ABC Insert WP WM
 One side teaches English letters, while the other features a red train moving along tracks, cultivating both language skills and logical thinking.
World Map Insert WP WM
 While recognizing world map and rotating clock hands to understand time zone differences, basic geographical concepts are easily built through interaction.
Four In A Row Insert WP WM
 While recognizing world map and rotating clock hands to understand time zone differences, basic geographical concepts are easily built through interaction.
Gears Insert WP WM
 Observing and analyzing operational patterns helps foster an initial understanding of the mechanical principle of "gear linkage," thereby cultivating foundational physical thinking.



Small Growth Ring & Clock Insert WP WM
 Move the clock hands to grasp the concepts of "hours and minutes," building foundational time awareness and logical thinking. The back features a small tiger pattern.
Small Crocodile Puzzle Insert WP WM
 Understand shape matching and spatial composition, fostering observation, concentration, and spatial logical thinking.
Puzzle Insert WP WM
 Puzzles help children grasp shape matching and spatial composition, fostering observation skills, concentration, and spatial logical thinking.
Small Window Insert WP WM
Small Cannon Insert WP WM

ROOFS



WP Square Leaf Roof



WP Hex Leaf Roof



WP Treehouse Gable Roof



NEW WP Regular Hexagon Triangle Shades



WM Treehouse leaf Roof



WM Treehouse - Half-hex Leaf Roof



WM Treehouse split level hex leaf



WM Treehouse - Gable Roof w/Batten



WM Treehouse - Gable Roof w/Tile

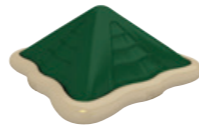

WP Pyramid Roof

THE WORX



WP WM Talk Tube



WP WM Rain Wheel



WP WM Bongo



WP Boston Castle - Hex Roof



WP Boston Castle - Square Roof



WP Castle - Battlement blockwall



WM Castle - Brick hex roof



WM Castle - Square Brick roof



WM Castle - battlement Stonewall



WP Saddle Seat



WP WM PE Stool



WP WM Rock and Roll ON



WP Sling Seat



WP Clover Seat



WP WM Palm Topper



WP Sailcloth Stained glass



WM Sailcloth - Black



WP WM 12.5ft x11ft Hex Shade Fabric



WP WM 12ft x12ft Square Shade Fabric



WP WM Pine Tree Topper



WP WM Grove Topper



WT Game Table



WT Leaf Table



WT Belt Seat



WT Wisetot Push and play



WP Gabble Leaf Roof



WP Leaf Roof



WP Two Post Leaf Roof



WP Single Post Leaf Roof



WP Two-post Roof



WP Arch Post Triangle Shade



WT PE Turntable



WP WM Bear Step



WP Standing Orbital Spinner



WT Split - Tier Roof



WT Gabble Roof



WP Hex Style Roof



WP Log Shed



WP 8-Unit Log Shed

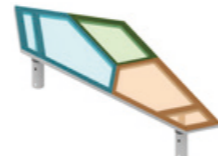

WP Two-post Colored Window Shed

COLOR SCHEMES

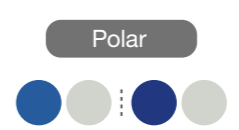
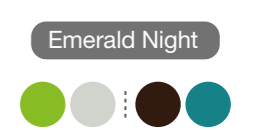
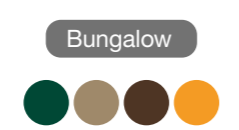
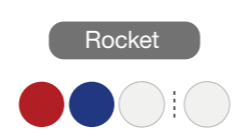
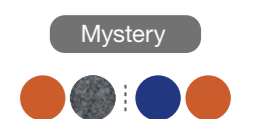
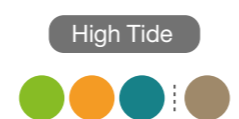
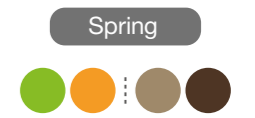
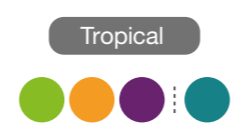
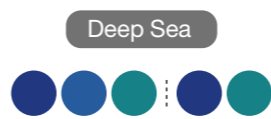
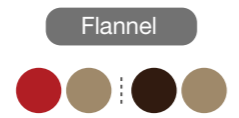
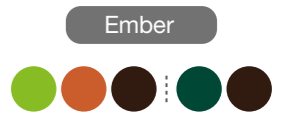
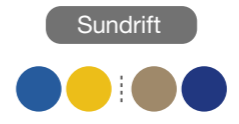
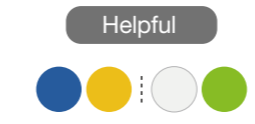
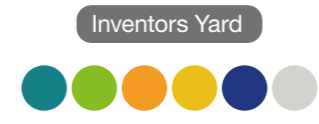
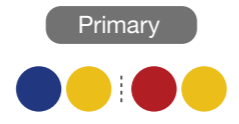

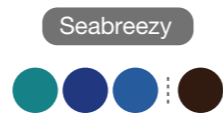
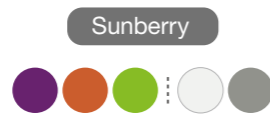
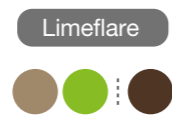
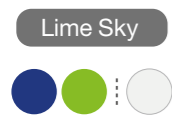
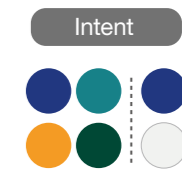
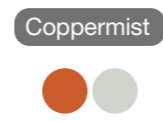
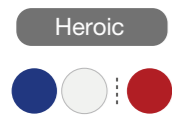
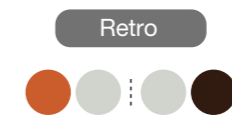
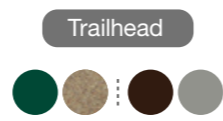
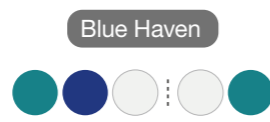
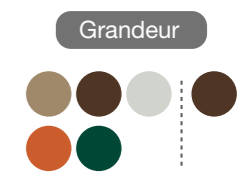
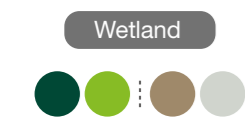
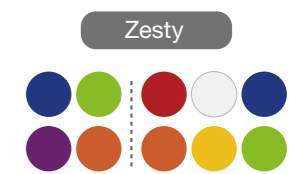
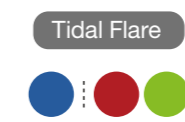
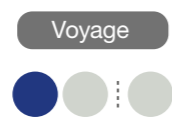

POWDER-COATED METAL COLORS



HDPE PANEL COLORS



DOUBLE-HDPE PANEL COLORS



ROTATIONAL PLASTIC COLORS



SHADE FABRIC COLORS

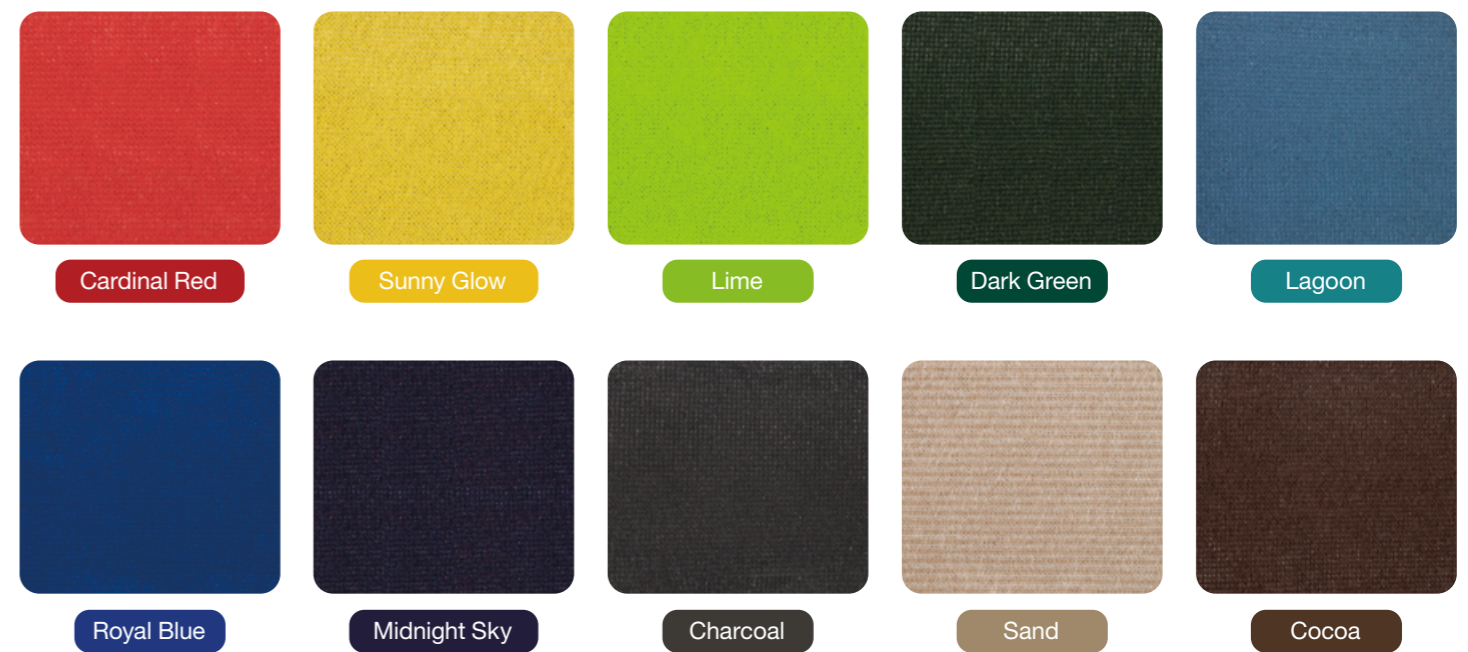

Index (Section Order)

10	QSWP-350106N06	NAPLES	18	QSWP-350003N11	LEAFY TIME	24	QSWP-350005N11	SHADY PINES	38	QSWP-350049N13	FALKVILLE
10	QSWP-350106P06	NAPLES	18	QSWP-350003P11	LEAFY TIME	24	QSWP-350005P11	SHADY PINES	38	QSWP-350049P13	FALKVILLE
10	QSWP-350106N11	NAPLES	18	QSWP-350003N12	LEAFY TIME	24	QSWP-350005N12	SHADY PINES	39	QSWP-350050N00	ASTER
10	QSWP-350106P11	NAPLES	18	QSWP-350003P12	LEAFY TIME	24	QSWP-350005P12	SHADY PINES	39	QSWP-350050P00	ASTER
10	QSWP-350106N12	NAPLES	18	QSWP-350003N13	LEAFY TIME	24	QSWP-350005N13	SHADY PINES	39	QSWP-350050N11	ASTER
10	QSWP-350106P12	NAPLES	18	QSWP-350003P13	LEAFY TIME	24	QSWP-350005P13	SHADY PINES	39	QSWP-350050P11	ASTER
10	QSWP-350106N13	NAPLES	18	QSWP-350105N00	POTOMAC	25	QSWP-350010N00	PLAY TIME	39	QSWP-350050N12	ASTER
10	QSWP-350106P13	NAPLES	18	QSWP-350105P00	POTOMAC	25	QSWP-350010P00	PLAY TIME	39	QSWP-350050P12	ASTER
11	QSWP-350065N00	GALENA	18	QSWP-350105N32	POTOMAC	25	QSWP-350010N11	PLAY TIME	39	QSWP-350050N13	ASTER
11	QSWP-350065P00	GALENA	18	QSWP-350105P32	POTOMAC	25	QSWP-350010P11	PLAY TIME	39	QSWP-350050P13	ASTER
11	QSWP-350065N32	GALENA	18	QSWP-350105N33	POTOMAC	25	QSWP-350010N12	PLAY TIME	39	QSWP-350007N00	YESTERYEARS
11	QSWP-350065P32	GALENA	18	QSWP-350105P33	POTOMAC	25	QSWP-350010P12	PLAY TIME	39	QSWP-350007P00	YESTERYEARS
11	QSWP-350065N33	GALENA	18	QSWP-350026N00	JUNGLE PLAY	25	QSWP-350010P13	PLAY TIME	39	QSWP-350007N11	YESTERYEARS
11	QSWP-350065P33	GALENA	18	QSWP-350026P00	JUNGLE PLAY	25	QSWP-350010P13	PLAY TIME	39	QSWP-350007P12	YESTERYEARS
11	QSWP-350019N00	HARPERS PLACE	18	QSWP-350026N11	JUNGLE PLAY	25	QSWP-350060N00	ZAK	39	QSWP-350007N12	YESTERYEARS
11	QSWP-350019P00	HARPERS PLACE	18	QSWP-350026P11	JUNGLE PLAY	25	QSWP-350060P00	ZAK	39	QSWP-350007P13	YESTERYEARS
11	QSWP-350019N32	HARPERS PLACE	18	QSWP-350026N12	JUNGLE PLAY	25	QSWP-350060N11	ZAK	39	QSWP-350057N00	SEQUOIA
11	QSWP-350019P32	HARPERS PLACE	18	QSWP-350026P12	JUNGLE PLAY	25	QSWP-350060P11	ZAK	39	QSWP-350057P00	SEQUOIA
11	QSWP-350019N33	HARPERS PLACE	18	QSWP-350026N13	JUNGLE PLAY	25	QSWP-350060N12	ZAK	40	QSWP-350057N11	SEQUOIA
11	QSWP-350019P33	HARPERS PLACE	18	QSWP-350026P13	JUNGLE PLAY	25	QSWP-350060P12	ZAK	40	QSWP-350057P11	SEQUOIA
12	QSWP-350011N00	BONGO PLAY	19	QSWP-350025N00	SPEED RACER	26	QSWP-350060N13	ZAK	40	QSWP-350057N12	SEQUOIA
12	QSWP-350011P00	BONGO PLAY	19	QSWP-350025P00	SPEED RACER	26	QSWP-350060P13	ZAK	40	QSWP-350057P12	SEQUOIA
12	QSWP-350011N11	BONGO PLAY	19	QSWP-350025N11	SPEED RACER	26	QSWP-350056N00	TURTLE ISLAND	40	QSWP-350057N13	SEQUOIA
12	QSWP-350011P11	BONGO PLAY	19	QSWP-350025P11	SPEED RACER	26	QSWP-350056P06	TURTLE ISLAND	40	QSWP-350057P13	SEQUOIA
12	QSWP-350011N12	BONGO PLAY	19	QSWP-350025N12	SPEED RACER	26	QSWP-350056N07	TURTLE ISLAND	40	QSWP-350047N00	WIGGLE WORM
12	QSWP-350011P12	BONGO PLAY	19	QSWP-350025P12	SPEED RACER	26	QSWP-350056P07	TURTLE ISLAND	40	QSWP-350047P00	WIGGLE WORM
12	QSWP-350011N13	BONGO PLAY	19	QSWP-350025N13	SPEED RACER	26	QSWP-350017N00	SUNNY STACK	40	QSWP-350047N11	WIGGLE WORM
12	QSWP-350011P13	BONGO PLAY	19	QSWP-350025P13	SPEED RACER	26	QSWP-350017P00	SUNNY STACK	40	QSWP-350047P11	WIGGLE WORM
12	QSWP-350066N00	SKYLER	19	QSWP-350002N00	SHININ BRIGHT	26	QSWP-350017N11	SUNNY STACK	40	QSWP-350047N12	WIGGLE WORM
12	QSWP-350066P00	SKYLER	19	QSWP-350002P00	SHININ BRIGHT	26	QSWP-350017P11	SUNNY STACK	40	QSWP-350047P13	WIGGLE WORM
12	QSWP-350066N32	SKYLER	19	QSWP-350002N11	SHININ BRIGHT	26	QSWP-350017N12	SUNNY STACK	40	QSWP-350052N00	GALILEO
12	QSWP-350066P32	SKYLER	19	QSWP-350002P11	SHININ BRIGHT	26	QSWP-350017P12	SUNNY STACK	40	QSWP-350052P00	GALILEO
12	QSWP-350066N33	SKYLER	19	QSWP-350002N12	SHININ BRIGHT	27	QSWP-350017N13	SUNNY STACK	40	QSWP-350052N06	GALILEO
12	QSWP-350066P33	SKYLER	19	QSWP-350002P12	SHININ BRIGHT	27	QSWP-350017P13	SUNNY STACK	40	QSWP-350052P06	GALILEO
13	QSWP-350064N00	WILD RUN	19	QSWP-350002N13	SHININ BRIGHT	27	QSWP-350042N00	BOBBIE	40	QSWP-350052N07	GALILEO
13	QSWP-350064P00	WILD RUN	19	QSWP-350002P12	SHININ BRIGHT	27	QSWP-350042P00	BOBBIE	40	QSWP-350052P07	GALILEO
13	QSWP-350064N11	WILD RUN	19	QSWP-350002N13	SHININ BRIGHT	27	QSWP-350042P11	BOBBIE	41	QSWP-350048N00	WORLD TRAVELER
13	QSWP-350064P11	WILD RUN	19	QSWP-350002P13	SHININ BRIGHT	27	QSWP-350042P12	BOBBIE	41	QSWP-350048P00	WORLD TRAVELER
13	QSWP-350064N12	WILD RUN	19	QSWP-350016N00	NORTHERN PLACE	27	QSWP-350042N12	BOBBIE	41	QSWP-350048N06	WORLD TRAVELER
13	QSWP-350064P12	WILD RUN	19	QSWP-350016P00	NORTHERN PLACE	27	QSWP-350042N13	BOBBIE	41	QSWP-350048P06	WORLD TRAVELER
13	QSWP-350064N13	WILD RUN	19	QSWP-350016N11	NORTHERN PLACE	27	QSWP-350042P13	BOBBIE	41	QSWP-350048N07	WORLD TRAVELER
13	QSWP-350064P13	WILD RUN	19	QSWP-350016P11	NORTHERN PLACE	27	QSWP-35004N00	SUNNY DAYS	41	QSWP-350048P07	WORLD TRAVELER
13	QSWP-350102N00	CHARLOTTE	19	QSWP-350016N12	NORTHERN PLACE	27	QSWP-350004P00	SUNNY DAYS	41	QSWP-350024N00	KIDZ CORNER
13	QSWP-350102P00	CHARLOTTE	19	QSWP-350016N13	NORTHERN PLACE	27	QSWP-350004N11	SUNNY DAYS	41	QSWP-350024P00	KIDZ CORNER
13	QSWP-350102N32	CHARLOTTE	19	QSWP-350016P12	NORTHERN PLACE	27	QSWP-350004N12	SUNNY DAYS	41	QSWP-350024N11	KIDZ CORNER
13	QSWP-350102P32	CHARLOTTE	19	QSWP-350016P13	NORTHERN PLACE	27	QSWP-350004P12	SUNNY DAYS	41	QSWP-350024P11	KIDZ CORNER
13	QSWP-350102N33	CHARLOTTE	19	QSWP-350009N00	AUGUSTA	27	QSWP-350004N13	SUNNY DAYS	41	QSWP-350024N12	KIDZ CORNER
13	QSWP-350102P33	CHARLOTTE	19	QSWP-350009P00	AUGUSTA	27	QSWP-350004P13	SUNNY DAYS	41	QSWP-350024P12	KIDZ CORNER
14	QSWP-350062N00	POETER	20	QSWP-350009N11	AUGUSTA	28	QSWP-350041N00	MINNIE	41	QSWP-350024N13	KIDZ CORNER
14	QSWP-350062P00	POETER	20	QSWP-350009P11	AUGUSTA	28	QSWP-350041P00	MINNIE	41	QSWP-350024P13	KIDZ CORNER
14	QSWP-350062N11	POETER	20	QSWP-350009N12	AUGUSTA	28	QSWP-350041N11	MINNIE	42	QSWP-350013N00	PIKES PEAK
14	QSWP-350062P11	POETER	20	QSWP-350009P12	AUGUSTA	28	QSWP-350041P11	MINNIE	42	QSWP-350013P00	PIKES PEAK
14	QSWP-350062N12	POETER	20	QSWP-350009N13	AUGUSTA	28	QSWP-350041N12	MINNIE	42	QSWP-350013N32	PIKES PEAK
14	QSWP-350062P12	POETER	20	QSWP-350009P13	AUGUSTA	28	QSWP-350041P12	MINNIE	42	QSWP-350013P32	PIKES PEAK
14	QSWP-350062N13	POETER	20	QSWP-350018N00	MOUNT RAINIER	28	QSWP-350041N13	MINNIE	42	QSWP-350013N33	PIKES PEAK
14	QSWP-350062P13	POETER	20	QSWP-350018P00	MOUNT RAINIER	28	QSWP-350041P13	MINNIE	42	QSWP-350013P33	PIKES PEAK
14	QSWP-350014N00	FALCON RIDGE	20	QSWP-350018N11	MOUNT RAINIER	28	QSWP-350043N00	JEREMY	42	QSWP-350053N00	TIME FLYER
14	QSWP-350014P00	FALCON RIDGE	20	QSWP-350018N12	MOUNT RAINIER	28	QSWP-350043P00	JEREMY	42	QSWP-350053P00	TIME FLYER
14	QSWP-350014N11	FALCON RIDGE	20	QSWP-350018P11	MOUNT RAINIER	28	QSWP-350043N11	JEREMY	42	QSWP-350053N11	TIME FLYER
14	QSWP-350014P11	FALCON RIDGE	20	QSWP-350018N12	MOUNT RAINIER	28	QSWP-350043P11	JEREMY	42	QSWP-350053P11	TIME FLYER
14	QSWP-350014N12	FALCON RIDGE	20	QSWP-350018P12	MOUNT RAINIER	28	QSWP-350043N12	JEREMY	42	QSWP-350053N12	TIME FLYER
14	QSWP-350014P12	FALCON RIDGE	20	QSWP-350018N13	MOUNT RAINIER	28	QSWP-350043P12	JEREMY	42	QSWP-350053P12	TIME FLYER
14	QSWP-350014N13	FALCON RIDGE	20	QSWP-350018P13	MOUNT RAINIER	28	QSWP-350043N13	JEREMY	42	QSWP-350053N13	TIME FLYER
14	QSWP-350014P13	FALCON RIDGE	20	QSWP-350045N00	JANIE	28	QSWP-350043P13	JEREMY	42	QSWP-350053P13	TIME FLYER
15	QSWP-350100N00	WILMINGTON	21	QSWP-350045P00	JANIE	28	QS76-21079	KIDZ BUS	43	TOT35CL-0004-121123	MADELINE
15	QSWP-350100P00	WILMINGTON	21	QSWP-350045N11	JANIE	28	QSWP-350037N00	MEMPHIS	43	TOT35CL-0011-121123	GNOMES HUT
15	QSWP-350100N11	WILMINGTON	21	QSWP-350045N12	JANIE	30	QSWP-350037P00	MEMPHIS	44	TOT35CL-0003-77121	DAHLIA
15	QSWP-350100P11	WILMINGTON	21	QSWP-350045P12	JANIE	30	QSWP-350037N32	MEMPHIS	46	QSF5-CL0036N	AKRON
15	QSWP-350100N12	WILMINGTON	21	QSWP-350045N13	JANIE	30	QSWP-350037P32	MEMPHIS	46	QSF5-CL0036P	AKRON
15	QSWP-350100P12	WILMINGTON	21	QSWP-350045P13	JANIE	30	QSWP-350037N33	MEMPHIS	47	QSF5-CL0013N	DALLAS
15	QSWP-350100N13	WILMINGTON	21	QSWP-350046N00	ROCKY	30	QSWP-350037P33	MEMPHIS	47	QSF5-CL0013P	DALLAS
15	QSWP-350100P13	WILMINGTON	21	QSWP-350046P00	ROCKY	32	QSWP-350038N00	ATLANTA	47	QSF5-CL0014N	THE CHALLENGER
15	QSWP-350107N00	MARYLAND	21	QSWP-350046P32	ROCKY	32	QSWP-350038P00	ATLANTA	47	QSF5-CL0014P	THE CHALLENGER
15	QSWP-350107P00	MARYLAND	21	QSWP-350046P33	ROCKY	32	QSWP-350038N32	ATLANTA	48	QSF5-CL0039N	BODEN
15	QSWP-350107N11	MARYLAND	22	QSWP-350046N33	ROCKY	32	QSWP-350038P32	ATLANTA	48	QSF5-CL0039P	BODEN
15	QSWP-350107P11	MARYLAND	22	QSWP-350021N00	AHOY MATE	32	QSWP-350038N33	ATLANTA	50	AS-350801-110	3.5" Arch Swing Frame 8ft-1 Bay
15	QSWP-350107N12	MARYLAND	22	QSWP-350021P00	AHOY MATE	34	QSWP-350038P33	ATLANTA	50	AS-350801-114	3.5" Arch Swing Frame 8ft-1 Bay
15	QSWP-350107P12	MARYLAND	22	QSWP-350021N11	AHOY MATE	34	QS76-21078	WISE DOC	50	AS-350802-110	3.5" Arch Swing Frame 8ft-2 Bay
15	QSWP-350107N13	MARYLAND	22	QSWP-350021P11	AHOY MATE	34	QS76-21076	WISE FIRE HOUSE	50	AS-350802-114	3.5" Arch Swing Frame 8ft-2 Bay
15	QSWP-350107P13	MARYLAND	22	QSWP-350021P12	AHOY MATE	35	QS76-21075	WISE GARDENER	50	AS-350803-110	3.5" Arch Swing Frame 8ft-3 Bay
16	QSWP-350067N00	MCKINLEY	22	QSWP-350021N13	AHOY MATE	35	QSYJ001366	ZOOMSTER	50	AS-350803-114	3.5" Arch Swing Frame 8ft-3 Bay
16	QSWP-350067P00	MCKINLEY	22	QSWP-350021P13	AHOY MATE	35	QSYJ001367	SKY COPTER SAM	50	AS-350804-110	3.5" Arch Swing Frame 8ft-4 Bay
16	QSWP-350067N11	MCKINLEY	22	QSWP-350008N00	BUGALOO	35	QSYJ001368	CHARLIE THE CHOOCHOO TRAIN	50	AS-350804-114	3.5" Arch Swing Frame 8ft-4 Bay
16	QSWP-350067P11	MCKINLEY	22	QSWP-350008P00	BUGALOO	35	QSYJ001370-V01	TUGBOAT TOM	50	SPS-0801-110	5" Single Post Swing 8ft-1 Bay
16	QSWP-350067N12	MCKINLEY	22	QSWP-350008N32	BUGALOO	35	76-21094	BERNICE THE BUS	50	SPS-0801-114	5" Single Post Swing 8ft-2 Bay
16	QSWP-350067P12	MCKINLEY	22	QSWP-350008P32	BUGALOO	36	QSYJ001369	FRANNY THE FIRE TRUCK	50	SPS-0802-110	5" Single Post Swing 8ft-2 Bay
16	QSWP-350067N13	MCKINLEY	22	QSWP-350008N33	BUGALOO	36	QSYJ001318-V02	HAPPY HARVESTER	50	SPS-0802-114	5" Single Post Swing 8ft-2 Bay
16	QSWP-350067P13	MCKINLEY	22	QSWP-350008P33	BUGALOO	36	QSYJ001320-V03	7 SEAS	50	SPS-0803-110	5" Single Post Swing 8ft-3 Bay
16	QSWP-350027N00	MIGHTY MAGIC	23	QSWP-350006N00	TIMBER TRACKS	37	QSWP-350055N00	ASHTON	50	SPS-0803-	

52	QSMR-210001N	BALANCED ROCK I
53	QSSR-21007	BEE RIDER
53	QSSR-21006	FIRE TRUCK RIDER
53	QSSR-21008	HORSE RIDER
53	QSSR-21004	PONY RIDER
53	QSSR-21005	WISESAW - DUO
53	SR-21039-110	ATV RIDER
53	SR-21040-121	BULLDOZER RIDER
54	QSHW1-S1A308	CATERPILLAR CRAWL TUNNEL-UNIT
54	QSHW1-S1A309	CATERPILLAR CRAWL TUNNEL-COMPLETE SET
54	QSHW1-S310-V01	TRAIN CRAWL TUNNEL-ENGINE
54	QSHW1-S311-V01	TRAIN CRAWL TUNNEL-CARRIAGE
55	QS75-21003-110	STAND & SPIN
55	QS75-21004-112	LOTUS SPINNER
55	QSL5-JSQ006N	WISE TOSS
55	QSL5-JSQ006P	WISE TOSS
55	QS72-21032	PLAYGROUND BALLS (SET OF 6)
55	QS72-22001	GFRC TIMBER CRAWL TUNNEL
55	63-21078	GFRC STUMP JUMP
55	QSF5-CL0019N	FROG HOPPER
55	FS-CL3524-116BN	TETHERBALL SET
55	QS75-21009-110	BALANCE BEAM
55	QS75-21012-111	LEAF BALANCE STEPS
56	QS78-21001	WISE BLACKBOARD
56	QS78-21002	WISE WHITE BOARD
56	QS78-21003	WISE PAINT BOARD
56	QSGP2-T072	WILD BUNCH
56	QS78-21006	CAREY THE CARRO
56	QS78-21007	ALLIE THE APPLE
56	QS78-21008	FIONA THE FLOWER(BLUE)
56	QS78-21008-77	FIONA THE FLOWER(PURPLE)
56	QS78-21008-121	FIONA THE FLOWER(ORANGE)
56	QS78-21008-118	FIONA THE FLOWER(RED)
56	QS78-21008-122	FIONA THE FLOWER(LIME)
56	QS72-22003	RAINBOW XYLOPHONE
56	QS72-22002	SPLIT RAINBOW XYLOPHONE
56	QSF5-WP0001N	ALTO
56	QS72-22004	BONGO DRUMS
57	QSTB-5208-2B2	8" TIMBER BORDER W/SPIKE
57	QSTB-5212-2B2	12" TIMBER BORDER W/SPIKE
57	QSTB-6244-2B2	HALF ADA RAMP
58	QSSAP-21001-110	6" RECTANGULAR PICNIC TABLE PERFORATED PATTERN
58	QSSAP-21002-IG-110	6" BENCH W/BACKPERFORATED PATTERN
58	QS72-21021-110	WISEBIN
58	QS72-21022-110	WISEBIN WITH RAIN COVER
58	QS72-21015-131	SINGLE BIKE RACK
58	QS72-21016-131	DOUBLE BIKE RACK
61	WT35NS-0005-114123	ALDEN'S ADVENTURE
63	WT35NS-0003-77114122	TUMBLE TOWER
64	WT35NS-0004-110122	EXPLORER'S LOOKOUT
65	WT35NS-0001-114123	TIMBER RUSH
66	WT35NS-0002-113118	RAPID RIDGE
67	WT35NS-0006-113123	EVERGREEN TOWER
68	WT35NS-0007-77121	OCEANIC
69	ST35NS-0001	ASPEN SUMMIT
71	ST35NS-0002	HONEYCREST
72	ST35NS-0003	HIGHGROVE
76	TOT35CL-0001	PEBBLE PATCH
77	TOT35CL-0005	TOADS PLAY
78	TOT35CL-0009	LITTLE SNUFFY
78	TOT35CL-0013	DAFFODIL
79	TOT35CL-0002	IRIS
80	TOT35CL-0006	COSMOS
80	TOT35CL-0010	POLLYWOGS
81	TOT35CL-0007	BEDDIA
81	TOT35CL-0014	MAISY
82	TOT35CL-0008	MARIGOLD
82	TOT35CL-0012	PETUNIA
84	PDWP-350090C13	TIPPY-TOE
85	PDWP-350097C12	ZOEY
85	PDWPPE-350001C15	TREBLE LEAF
86	PDWP-350098C11	SWEET MAY
86	PDWP-350099C11	LITTLE STAR
87	YJ001316-V04	FIRE ENGINE
88	YJ001317-V03	BEEP JEEP
88	YJ001319-V02	AIRPLANE
89	76-21113	LITTLE ACRES
89	76-21112	TINY ACRES
90	76-21114	CROAKER CABIN
90	76-21111	CAMP BOGGY
90	76-21116	THE LEARNING LODGE
91	76-21118	TOADSTOOL BURROW
92	76-21117	FROGGY HOLLOW
92	76-21115	DISCOVERY DEN
96	PDWP-350121C33	SAN ANTONIO
97	PDWP-350125C3A	AMARILLO
98	PDWP-350118C32	PALM BAY COVE
99	PDWP-350073C00	CHARLOTTE'S FUN ZONE
100	PDWP-350115C32	FORKS PARK
101	PDWP-350075C33	ISLAND WONDER
102	PDWP-350126C32	SHIFTING SANDS
103	PDWP-350072C33	WISE TRAVELER
104	PDWP-350127C33	TIGER LILY
106	PDWP-350128C32	IRONRIDGE
107	PDWP-350140C3A	SWALE
108	PDWP-350141C00	CALDER
108	PDWP-350139C00	CHRONOS
108	PDWP-350142C13	SILAS
109	PDWP-350030C00	SUNDAZED
110	PDWP-350031C32	PINNWHEEL PARADE
111	PDWP-350032C32	PARADISE
112	PDWP-350029C32	MOONDRAP
113	PDWP-350034C00	GOLDSTAR
114	PDWP-350129C32	DOODLEBUG
115	PDWP-350130C11	SNAPDRAGON
116	PDWP-350131C00	JINXBERRY
117	PDWP-350132C13	GALAXY GIGGLE
118	PDWP-350133C33	LUMIN
119	PDWP-350134C00	NIMBLENOOK
120	PDWP-350077C15	TWISTER
121	PDWP-350082C32	JUNGLEGEM
122	PDWP-350083C00	ROVER RIDER
122	PDWP-350135C12	THICKET
123	PDWP-350085C32	BRISK SEABREEZE
124	PDWP-350136C00	FOUNDRY
125	PDWP-350089C13	TERRYS MAZE
126	PDWP-350091C32	LIGHTHOUSE
127	PDWPPE-350023C	WAYWELL
128	PDWP-350109C32	GLENROCK HEIGHTS

129	PDWP-350124CC	LINDEN LOOP
130	PDWP-350092C00	AMBERLEY
131	PDWP-350113C33	SAN TAN VILLAGE
132	PDWP-350143C32	ASHEVILLE TOWER
133	PDWP-350112C32	HUNTSVILLE LOOKOUT
134	PDWP-350137C32	ALLISTER
135	PDWP-350114C00	MERIDIANVILLE
136	PDWP-350039C32	SALMON
137	WPPE-350012C	WILDWOOD HEIGHTS
138	PDWP-350138C3A	SPARKLECREST
140	WPPE-350013C	ROCKET FLYER
141	WPPE-350024C	FIREHOUSE HOLLOW
142	WPPE-350017C	JUNGLE FRIENDS
143	WPPE-350020C	SKY SEEKER
144	WPPE-350022C	ANCHORAGE BAY
145	WPPE-350018C	DEEP DIVER
146	WPPE-350014C	BRIGHTO
146	WPPE-350015C	ALLIE GATOR
147	WPPE-350003C00	SHREVEPORT
148	WPPE-350009C	FARMERS TOWER
149	WPPE-350011C	CHOO CHOO CABOOSE
150	BS35CS-0001	WISE KINGDOM
152	PDAT5OCL-0016C	MINA
154	PDAT5OCL-0003C	SUNSHINE SUMMIT
155	PDAT5OCL-0017C	ANCHORLIGHT POINT
156	PDAT5OCL-0018C	GIZMO
157	PDAT5OCL-0019C	WANDERWOOD CANOPY
158	PDAT5OCL-0020C	SALT PETAL
158	PDAT5OCL-0002C	ROCHESTER
160	PDAT5OCL-0005C	SUNSET MOUNTAIN
162	PDAT5OCL-0021C	SUNSWALLOW WILDERNESS
163	PDAT5OCL-0022C	BOUNDLESS
164	PDAT5OCL-0023C	TRAIL TANGLE
165	PDAT5OCL-0008C	FRESHWATER
166	PDAT5OCL-0014C	FIREFLY HIDEAWAY
167	PDAT5OCL-0010C	ELLIE'S CHALLENGE
168	PDAT5OCL-0011C	CEDAR FORT
170	AT50TH-0001	BRIARSTEAD
172	AT50CS-0001	CASTLE PEAK
173	AT50PS-0001	SCALAWAGS
174	AT50PS-0002	ATLANTIS SEAS
177	LS-JSQ005	LEAP PADS
177	LS-JSQ004	HORIZONTAL PLAYGROUND NET
177	LS-JSQ003	WAVY PARALLEL BARS
177	LS-JSQ001	LEAP CLIMBER
177	LS-JSQ002	NET & ROCK CLIMBER
178	63-21029	UP & OVER CLIMBE
178	63-21031	DOUBLE UP & OVER CLIMBER
178	FS-CL0020N	WISE BAR - DUAL LEVEL
178	FS-CL0021N	WISE BAR - TRI LEVEL
179	79-23001	WISE BENCH
179	79-23003	WISE PUSH UP BARS
179	79-23002	WISE BACK STRETCH
179	79-23004	WISE LIFT
179	79-23005	WISE STEP UP
180	SAD-21003-110	8FT RECTANGLE TABLE DIAMOND PATTERN
180	SAD-21004-110	46" ROUND TABLE 4 SEATS DIAMOND PATTERN
180	SAD-21005-110	ADA 46" ROUND TABLE 3 SEATS DIAMOND PATTERN
180	SA-21007-110	WISE CUSTOMIZABLE BENCH
181	72-21017-111	TRIPLE BIKE RACK
181	72-21055-114118	BARK N' OVER
181	72-21055-113110	BARK N' OVER
181	72-21056-114118	PAW HOPPER
181	72-21056-110113	PAW HOPPER
181	72-21057-118	PAW WEAVER
181	72-21057-111	PAW WEAVER
182	72-21085-114118	WASTE STATION
182	72-21085-110111	WASTE STATION
182	72-21059-114118	TERRIER TUNNEL
182	72-21059-113110	TERRIER TUNNEL
182	72-21060-112114118	PAWTASTIC TUNNEL
182	72-21060-110113	PAWTASTIC TUNNEL
182	72-21061-112118	PAWTASTIC
182	72-21061-110113	PAWTASTIC
182	72-21062-114118	POOCH HOOPS
182	72-21062-110111	POOCH HOOPS
182	72-21058-112118	PAWSITIVE JUMP
182	72-21058-110113	PAWSITIVE JUMP
182	72-21063-114118	TOTTER PAW
182	72-21063-110113	TOTTER PAW
182	72-21064-112118	PAWSITIVELY TABLE
182	72-21064-110113	PAWSITIVELY TABLE
185	WN-002C	CLIMBERS TRAVERSE
185	WN-001C	TWISTED MESH
185	WN-003C	WISE WEB
186	WN-006C	SPIDER CRAWL
186	WN-007C	TANGLE PATH
186	WN-004C	NET RUNNER
186	WN-005C	TRIPOD TRAVERSE
187	WN-76-21091	ORBITER CLIMBER
187	WN-74-21028	ORB CHALLENGE
187	WN-74-21018	VERTEX
187	WN-74-21033	THE RAMESSES
187	WN-74-21034	KING TUT
188	WN-74-21107	PIVOT POINT
188	WN-76-21092	CONVEYOR CAVE
188	PDFS-CL0028C	SPIDER
188	FS-CL0032C-114122	ADA SPIDER CLIMBING SET
189	75-21046	SPIN NEST
189	75-21047	LITTLE ORBITER
189	80-210013	RUSH RUNNER
189	FS-CL0040	ZOOMLINE ZIPPER
189	FS-CL3524-094BN	SKY REACH ASCENT CLIMBER
189	76M-002-110113	JUNGLE SPROUTS CLIMBER
190	PDFS-CL0024C	TRIFECTA CHALLENGE
191	PDFS-CL0011C	FUN WAYS
191	PDFS-CL0012C	WOBBLEY WAY
192	PDFS-CL0031C	DOJO
192	PDFS-CL0030C	WILDER
193	PDQB-210013C	DRAGONFLY
193	PDQB-210010C	VISIONARY
194	QB-210012P	QUBE CLIMB AND SLIDE
194	QB-210003	DOUBLE TROUBLE QUBE
194	QB-210009N	GRAVITRON
194	QB-210005	PROFESSORS QUBE
195	MR-210006N	PARK AVENUE
195	MR-210005P	DOUBLE ARCH
195	MR-210004C	LA SAL
195	MR-210001C	BALANCED ROCK

195	MR-210002C	DELICATE ARCH
195	MR-210003C	THE WINDOWS
196	WS-210003	CANYON LANDS
196	WS-210004	BUGGY
196	WS-210005C	SLICKROCK
197	HW1-S1A352	WISETRAIN - REGULAR SET
197	HW1-S1A353	WISETRAIN - CORNER SET
198	HW1-S1A359	Outdoor Motor Skills-TrainEngine
198	HW1-S1A354	Outdoor Motor Skills-TrainBridging Carriage
198	HW1-S1A355	Outdoor Motor Skills-TrainClimbing Carriage
198	HW1-S1A356	Outdoor Motor Skills-TrainEntrance Carriage
198	HW1-S1A357	Outdoor Motor Skills-TrainRope Maze Carriage
198	HW1-S1A358	Outdoor Motor Skills-TrainCrawl Tunnel
198	HW1-S1A359	Outdoor Motor Skills-TrainClimbing Bridge
198	HW1-S1A360	Outdoor Motor Skills-TrainRopes Balance
198	HW1-S1A361	Outdoor Motor Skills-TrainStumps Balance
198	HW1-S1A362	Outdoor Motor Skills-TrainStepping Leaves Balance Bar
198	HW1-S1A363	Outdoor Motor Skills-TrainMushroom Stones Balance Bar
198	HW1-S1A364	360 FREESTANDING SPIRAL SLIDE
199	FS-SL7200N	270 FREESTANDING SPIRAL SLIDE
199	FS-SL6000P	WIGGLY RACE
199	FS-SL72033N	4" FREESTANDING SINGLE SLIDE
199	FS-SL4801N	4" FREESTANDING DOUBLE SLIDE
199	FS-SL4802P	TWISTY WOO
200	75-21072	ROCK AND ROLL ON
200	76AM-002	DIZZY DINO EGG
200	75-21073	TWIRL A WHIRL
200	75-21014-114	ADA TWIRL A WHIRL
200	75-21039-122131	DOUBLE GEXX CRAWL TUBE
201	76-21164-121123	DOUBLE GEXX CRAWL TUBE
201	76-21164-110113	DOUBLE GEXX CRAWL TUBE
201	76-21164-77112	GEXX CRAWL TUBE
201	76-21165-77112	GEXX CRAWL TUBE
201	76-21165-121123	GEXX CRAWL TUBE
201	76-21165-110113	GEXX CRAWL TUBE
201	72-21097-112	GLIDE RIDE
202	76-21137-114122	GAGA PIT
202	72-21098-122	CORN BOARD
202	PDFS-CL0010C	BRAIN GAMES
202	HW1-S101	THROUGH THE JUNGLE-SINGLE
202	HW1-S101-1	THROUGH THE JUNGLE - SET OF 8
202	75-21024	CIRCLE CYCLE TRIKE
203	FS-21089-10114	ASHTON'S QUIET COVE
203	FS-WP0005C	SENSORY STATION PAIR
203	FS-WP0002C	SENSORY STATION QUAD SET
204	SR-21010	WISEBOUNCE & BALANCE
204	SR-21012-113	WISESAW - QUAD
204	SR-21009	WISESAW - TRI
204	SR-21030	SEESAW
204	SR-21046	4-SEAT SEESAW (SILVER GRAY & LIME)
205	SR-21020-114	WHALE RIDER
205	SR-21019-112	BEE RIDER
205	SR-21022-131	ELEPHANT RIDER
205	SR-21021-129	ROCKET RIDER
205	SR-21023-130	PLANE RIDER
205	SR-21027-123130	TRAVEL RIDER
206	SR-21025-10114	2-SEAT SPACESHIP RIDER
206	SR-21024-123	2-SEAT BOAT RIDER
206	SR-21028-77	SPIRAL SHELL STANDING RIDER
206	SR-21029	FISH STANDING RIDER
206	SR-21026-110	DINO RIDER
206	SR-21015-77121	WISE DIG
207	SPS-0801-SF-113	5" Single Post Swing w/ Shade 8ft-1 Bay
207	SPS-0802-SF-113	5" Single Post Swing w/ Shade 8ft-2 Bay
207	SPS-0803-SF-113	5" Single Post Swing w/ Shade 8ft-3 Bay
207	SPS-0804-SF-113	5" Single Post Swing w/ Shade 8ft-4 Bay
207	SS-0011	Full Bucket Seat & Galvanized Steel Chain Set
207	SS-0012	Belt Seat & Galvanized Steel Chain Set
207	FAS-35091D-DS	FREEDOM ARC
207	SS-036-110	Freedom Arch Swing Frame
207	SS-039-113	Freedom Flyer
207	AS350800-MM	LITTLE BREEZE SWING
207	AS-350800-110	Single Arch Swing Frame
207	SS-042-113	Sapling Swing
207	75-21031-110113	BELT WALK
208	72-21099	SOUNDWAVE
208	72-21100	HARMONY RAIL
208	72-21102	TEMPO TULIPS
208	72-21101	PERCUSSION PALS
208	72-21103	BLOOM BEATS
212	B-C001	GROW AND GO

Index (Section Order)

57	QSTB-5212-2B2	12" TIMBER BORDER W/SPIKE
199	FS-SL6000P	270 FREESTANDING SPIRAL SLIDE
206	SR-21024-123	2-SEAT BOAT RIDER
206	SR-21025-10114	2-SEAT SPACESHIP RIDER
50	AS-350801-110	3.5" Arch Swing Frame 8ft-1 Bay
50	AS-350801-114	3.5" Arch Swing Frame 8ft-1 Bay
50	AS-350802-110	3.5" Arch Swing Frame 8ft-2 Bay
50	AS-350802-114	3.5" Arch Swing Frame 8ft-2 Bay
50	AS-350803-110	3.5" Arch Swing Frame 8ft-3 Bay
50	AS-350803-114	3.5" Arch Swing Frame 8ft-3 Bay
50	AS-350804-110	3.5" Arch Swing Frame 8ft-4 Bay
50	AS-350804-114	3.5" Arch Swing Frame 8ft-4 Bay
199	FS-SL7200N	360 FREESTANDING SPIRAL SLIDE
199	FS-SL4802P	4' FREESTANDING DOUBLE SLIDE
199	FS-SL4801N	4' FREESTANDING SINGLE SLIDE
180	SAD-21004-110	46" ROUND TABLE 4 SEATS DIAMOND PATTERN
204	SR-21046	4-SEAT SEESAW (SILVER GRAY & LIME)
52	QSFS-SL6001WCN	5' FREESTANDING SINGLE SLIDE
52	QSFS-SL6001WCP	5' FREESTANDING SINGLE SLIDE
50	SPS-0801-1A-110	5" Single Post Swing 8ft 1- Bay W/ARM
50	SPS-0801-1A-114	5" Single Post Swing 8ft 1- Bay W/ARM
50	SPS-0801-110	5" Single Post Swing 8ft-1 Bay
50	SPS-0801-114	5" Single Post Swing 8ft-1 Bay
50	SPS-0802-110	5" Single Post Swing 8ft-2 Bay
50	SPS-0802-114	5" Single Post Swing 8ft-2 Bay
50	SPS-0803-110	5" Single Post Swing 8ft-3 Bay
50	SPS-0803-114	5" Single Post Swing 8ft-3 Bay
50	SPS-0804-110	5" Single Post Swing 8ft-4 Bay
50	SPS-0804-114	5" Single Post Swing 8ft-4 Bay
50	SPS-0801-TS-110	5" Single Post Swing Bucket Tree Swing
50	SPS-0801-TS-114	5" Single Post Swing Bucket Tree Swing
207	SPS-0801-SF-113	5" Single Post Swing w/ Shade 8ft-1 Bay
207	SPS-0802-SF-113	5" Single Post Swing w/ Shade 8ft-2 Bay
207	SPS-0803-SF-113	5" Single Post Swing w/ Shade 8ft-3 Bay
207	SPS-0804-SF-113	5" Single Post Swing w/ Shade 8ft-4 Bay
58	QSSAP-21002-IG-110	6' BENCH W/BACKPERFORATED PATTERN
52	QSFS-SL7203LSN	6' FREESTANDING SINGLE SLIDE
52	QSFS-SL7203LSP	6' FREESTANDING SINGLE SLIDE
58	QSSAP-21001-110	6' RECTANGULAR PICNIC TABLE PERFORATED PATTERN
30	QSYJ001320-V03	7' SEAS
57	QSTB-5208-2B2	8" TIMBER BORDER W/SPIKE
180	SAD-21003-110	8FT RECTANGLE TABLE DIAMOND PATTERN
180	SAD-21005-110	ADA 46" ROUND TABLE 3 SEATS DIAMOND PATTERN
188	FS-CL0032C-114122	ADA SPIDER CLIMBING SET
200	75-21039-122131	ADA TWIRL A WHIRL
50	SS-0190G-JS	Adaptive Swing Seat (Green)
50	SS-0190R-JS	Adaptive Swing Seat (Red)
22	QSWP-350021N00	AHOY MATE
22	QSWP-350021P00	AHOY MATE
22	QSWP-350021N11	AHOY MATE
22	QSWP-350021P11	AHOY MATE
22	QSWP-350021N12	AHOY MATE
22	QSWP-350021P12	AHOY MATE
22	QSWP-350021N13	AHOY MATE
22	QSWP-350021P13	AHOY MATE
88	YJ001319-V02	AIRPLANE
46	QSFS-CL0036N	AKRON
46	QSFS-CL0036P	AKRON
61	WT35NS-0005-114123	ALDEN'S ADVENTURE
146	WPPE-350015C	ALLIE GATOR
56	QS78-21007	ALLIE THE APPLE
134	PDWP-350137C32	ALLISTER
56	QSFS-WP0001N	ALTO
97	PDWP-350125C3A	AMARILLO
130	PDWP-350092C00	AMBERLEY
144	WPPE-350022C	ANCHORAGE BAY
155	PDAT50CL-0017C	ANCHORLIGHT POINT
132	PDWP-350143C32	ASHEVILLE TOWER
37	QSWP-350055N00	ASHTON
37	QSWP-350055P00	ASHTON
37	QSWP-350055N11	ASHTON
37	QSWP-350055P11	ASHTON
37	QSWP-350055N12	ASHTON
37	QSWP-350055P12	ASHTON
37	QSWP-350055N13	ASHTON
37	QSWP-350055P13	ASHTON
203	76-21089-10114	ASHTON'S QUIET COVE
69	ST35NS-0001	ASPEN SUMMIT
39	QSWP-350050N00	ASTER
39	QSWP-350050P00	ASTER
39	QSWP-350050N11	ASTER
39	QSWP-350050P11	ASTER
39	QSWP-350050N12	ASTER
39	QSWP-350050P12	ASTER
39	QSWP-350050N13	ASTER
39	QSWP-350050P13	ASTER
32	QSWP-350038N00	ATLANTA
32	QSWP-350038P00	ATLANTA
32	QSWP-350038N32	ATLANTA
32	QSWP-350038P32	ATLANTA
32	QSWP-350038N33	ATLANTA
32	QSWP-350038P33	ATLANTA
174	AT50PS-0002	ATLANTIS SEAS
53	SR-21039-110	ATV RIDER
20	QSWP-350009N00	AUGUSTA
20	QSWP-350009P00	AUGUSTA
20	QSWP-350009N11	AUGUSTA
20	QSWP-350009P11	AUGUSTA
20	QSWP-350009N12	AUGUSTA
20	QSWP-350009P12	AUGUSTA
20	QSWP-350009N13	AUGUSTA
20	QSWP-350009P13	AUGUSTA
55	QS75-21009-110	BALANCE BEAM
195	MR-210001C	BALANCED ROCK
52	QSMR-210001N	BALANCED ROCK I
181	72-21055-114118	BARK N' OVER
181	72-21055-113110	BARK N' OVER
81	TOT35CL-0007	BEDELIA
53	QSSR-21007	BEE RIDER
205	SR-21019-112	BEE RIDER
88	YJ001317-V03	BEEP JEEP
50	SS-0012	Belt Seat & Galvanized Chain Set (Blue)
50	SS-0012	Belt Seat & Galvanized Chain Set (Dark Green)
50	SS-0012	Belt Seat & Galvanized Chain Set (Midnight)

50	SS-0012	Belt Seat & Galvanized Chain Set (Red)
50	SS-0012	Belt Seat & Galvanized Chain Set (Yellow)
207	SS-0012	Belt Seat & Galvanized Steel Chain Set
207	75-21031-110113	BELT WALK
35	76-21094	BERNICE THE BUS
214	B-C006A	BERNWOOD
38	QSWP-350051N00	BITTERROOT
38	QSWP-350051P00	BITTERROOT
38	QSWP-350051N11	BITTERROOT
38	QSWP-350051P11	BITTERROOT
38	QSWP-350051N12	BITTERROOT
38	QSWP-350051P12	BITTERROOT
38	QSWP-350051N13	BITTERROOT
38	QSWP-350051P13	BITTERROOT
208	72-21103	BLOOM BEATS
27	QSWP-350042N00	BOBBIE
27	QSWP-350042P00	BOBBIE
27	QSWP-350042N11	BOBBIE
27	QSWP-350042P11	BOBBIE
27	QSWP-350042N12	BOBBIE
27	QSWP-350042P12	BOBBIE
27	QSWP-350042N13	BOBBIE
27	QSWP-350042P13	BOBBIE
48	QSFS-CL0039N	BODEN
48	QSFS-CL0039P	BODEN
56	QS72-22004	BONGO DRUMS
12	QSWP-350011N00	BONGO PLAY
12	QSWP-350011P00	BONGO PLAY
12	QSWP-350011N11	BONGO PLAY
12	QSWP-350011P11	BONGO PLAY
12	QSWP-350011N12	BONGO PLAY
12	QSWP-350011P12	BONGO PLAY
12	QSWP-350011N13	BONGO PLAY
12	QSWP-350011P13	BONGO PLAY
12	PDAT50CL-0022C	BOUNDLESS
163	PDFS-CL0010C	BRAIN GAMES
202	AT50TH-0001	BRIARSEAT
170	PDWP-350085C32	BRISK STABREEZE
214	B-C009A	BRISTLECONE
146	WPPE-350014C	BRONTO
22	QSWP-350008N00	BUGALOO
22	QSWP-350008P00	BUGALOO
22	QSWP-350008N32	BUGALOO
22	QSWP-350008P32	BUGALOO
22	QSWP-350008N33	BUGALOO
22	QSWP-350008P33	BUGALOO
196	WS-210004	BUGGY
53	SR-21040-121	BULLDOZER RIDER
108	PDWP-350141C00	CALDER
90	76-21111	CAMP BOGGY
196	WS-210003	CANYON LANDS
56	QS78-21006	CAREY THE CARRO
172	AT50CS-0001	CASTLE PEAK
54	QSHW1-S1A309	CATERPILLAR CRAWL TUNNEL-COMplete SET
54	QSHW1-S1A308	CATERPILLAR CRAWL TUNNEL-UNIT
168	PDAT50CL-0011C	CEDAR FORT
35	QSYJ001368	CHARLIE THE CHOOCHOO TRAIN
13	QSWP-350102N00	CHARLOTTE
13	QSWP-350102P00	CHARLOTTE
13	QSWP-350102N32	CHARLOTTE
13	QSWP-350102P32	CHARLOTTE
13	QSWP-350102N33	CHARLOTTE
13	QSWP-350102P33	CHARLOTTE
99	PDWP-350073C00	CHARLOTTE'S FUN ZONE
149	WPPE-350011C	CHOO CHOO CABOOSE
108	PDWP-350139C00	CHRONOS
220	HW1-S286-VA	CHUCK
202	75-21024	CIRCLE CYCLE TRIKE
202	WIN-002C	CLIMBERS TRAVERSE
188	WN-76-21092	CONVEYOR CAVE
202	72-21098-122	CORN BOARD
224	F-A003A2	CORVIN
80	TOT35CL-0006	COSMOS
90	76-21114	CROAKER CABIN
78	TOT35CL-0013	DAFFOILDIL
44	TOT35CL-0003-77121	DAHLIA
47	QSFS-CL0013N	DALLAS
47	QSFS-CL0013P	DALLAS
216	B-D004A	DANCING MOLLY
145	WPPE-350018C	DEEP DIVER
52	QSMR-210002P	DELICATE ARCH
195	MR-210002C	DELICATE ARCH
24	QSWP-350022N00	DENVER
24	QSWP-350022P00	DENVER
24	QSWP-350022N11	DENVER
24	QSWP-350022P11	DENVER
24	QSWP-350022N12	DENVER
24	QSWP-350022P12	DENVER
24	QSWP-350022N13	DENVER
24	QSWP-350022P13	DENVER
206	SR-21026-110	DINO RIDER
92	76-21115	DISCOVERY DEN
200	75-21073	DIZZY DINO EGG
192	PDFS-CL0031C	DOJO
114	PDWP-350129C32	DODDLEBUG
195	MIR-210006P	DOUBLE ARCH
58	QS72-21016-131	DOUBLE BIKE RACK
201	76-21164-121123	DOUBLE GEXX CRAWL TUBE
201	76-21164-110113	DOUBLE GEXX CRAWL TUBE
201	76-21164-77112	DOUBLE GEXX CRAWL TUBE
194	QB-210003	DOUBLE TROUBLE QUBE
178	63-21031	DOUBLE UP & OVER CLIMBER
193	PDQB-210013C	DRAGONFLY
205	SR-21022-131	ELEPHANT RIDER
205	HW1-S287-VA	ELLA
167	PDAT50CL-0010C	ELLIE'S CHALLENGE
215	B-B009A	ELTZ
67	WT35NS-0006-113123	EVERGREEN TOWER
64	WT35NS-0004-110122	EXPLORER'S LOOKOUT
14	QSWP-350014N00	FALCON RIDGE
14	QSWP-350014P00	FALCON RIDGE
14	QSWP-350014N11	FALCON RIDGE
14	QSWP-350014P11	FALCON RIDGE
14	QSWP-350014N12	FALCON RIDGE

14	QSWP-350014P12	FALCON RIDGE
14	QSWP-350014N13	FALCON RIDGE
14	QSWP-350014P13	FALCON RIDGE
38	QSWP-350049N00	FALKVILLE
38	QSWP-350049P00	FALKVILLE
38	QSWP-350049N11	FALKVILLE
38	QSWP-350049P11	FALKVILLE
38	QSWP-350049N12	FALKVILLE
38	QSWP-350049P12	FALKVILLE
38	QSWP-350049N13	FALKVILLE
38	QSWP-350049P13	FALKVILLE
148	WPPE-350009C	FARMERS TOWER
56	QS78-21008	FIONA THE FLOWER(BLUE)
56	QS78-21008-122	FIONA THE FLOWER(LIME)
56	QS78-21008-121	FIONA THE FLOWER(ORANGE)
56	QS78-21008-77	FIONA THE FLOWER(PURPLE)
56	QS78-21008-118	FIONA THE FLOWER(RED)
87	YJ001319-V04	FIRE ENGINE
53	QSSR-21006	FIRE TRUCK RIDER
166	PDAT50CL-0014C	FIREFLY HIDEAWAY
141	WPPE-350024C	FIREHOUSE HOLLOW
206	SR-21029	FISH STANDING RIDER
100	PDWP-350115C32	FORKS PARK
124	PDWP-350136C00	FOUNDRY
36	QSYJ001369	FRANNY THE FIRE TRUCK
207	FAS-35091D-DS	FREEDOM ARC
207	SS-036-110	Freedom Arch Swing Frame
207	SS-039-113	Freedom Flyer
165	PDAT50CL-0008C	FRESHWATER
55	QSFS-CL0019N	FROG HOPPER
92	76-21117	FROGGY HOLLOW
50	SS-0011	Full Bucket Seat & Galvanized Steel Chain Set
207	SS-0011	Full Bucket Seat & Galvanized Steel Chain Set
191	PDFS-CL0011C	GAGA PIT
202	76-21137-114122	GALAXY GIGGLE
117	PDWP-350132C13	GALENA
11	QSWP-350065N00	GALENA
11	QSWP-350065P00	GALENA
11	QSWP-350065N32	GALENA
11	QSWP-350065P32	GALENA
11	QSWP-350065N33	GALENA
11	QSWP-350065P33	GALENA
40	QSWP-350052N00	GALILEO
40	QSWP-350052P00	GALILEO
40	QSWP-350052N06	GALILEO
40	QSWP-350052P06	GALILEO
40	QSWP-350052N07	GALILEO
201	76-21165-77112	GEXX CRAWL TUBE
201	76-21165-121123	GEXX CRAWL TUBE
201	76-21165-110113	GEXX CRAWL TUBE
55	63-21078	GFRG STUMP JUMP
55	QS72-22001	GFRG TIMBER CRAWL TUNNEL
156	PDAT50CL-0018C	GIZMO
225	F-C004A1	GLACIER EXPRESS
128	PDWP-350109C32	GLENROCK HEIGHTS
201	72-21097-112	GLIDE RIDE
43	TOT35CL-0011-121123	GNOMES HUT
113	PDWP-350034C00	GOLDSTAR
194	QB-210009N	GRAVITRON
212	B-C001	GROW AND GO
220	HW1-S288-VA	HAL
57	QSTB-6244-2B2	HALF ADA RAMP
36	QSYJ001318-V02	HAPPY HARVESTER
208	72-21100	HARMONY RAIL
11	QSWP-350019N00	HARRPERS PLACE
11	QSWP-350019P00	HARRPERS PLACE
11	QSWP-350019N32	HARRPERS PLACE
11	QSWP-350019P32	HARRPERS PLACE
11	QSWP-350019N33	HARRPERS PLACE
11	QSWP-350019P33	HARRPERS PLACE
219	HW1-S289-VA	HAWAIIAN HUT
37	QSWP-350054N00	HIDEOUT
37	QSWP-350054P00	HIDEOUT
37	QSWP-350054N06	HIDEOUT
37	QSWP-350054P06	HIDEOUT
37	QSWP-350054N07	HIDEOUT
37	QSWP-350054P07	HIDEOUT
72	ST35NS-0003	HIGHGROVE
218	HW1-S291-VA	HIKER'S HIDEOUT
71	ST35NS-0002	HONEYCREST
177	LS-JSQC004	HORIZONTAL PLAYGROUND NET
53	QSSR-21008	HORSE RIDER
223	F-A009A2	HOT PORTER
133	PDWP-350112C32	HUNTSVILLE LOOKOUT
79	TOT35CL-0002	IRIS
106	PDWP-350128C32	IRONRIDGE
101	PDWP-350075C33	ISLAND WONDER
21	QSWP-350045N00	JANIE
21	QSWP-350045P00	JANIE

23 QSWP-350023N13 OLYMPIA
23 QSWP-350023P13 OLYMPIA
187 WN-74-21028 ORB CHALLENGE
187 WN-76-21091 ORBITER CLIMBER
198 HW1-S1A354 Outdoor Motor Skills-TrainBridging Carriage
198 HW1-S1A358 Outdoor Motor Skills-TrainClimbing Bridge
198 HW1-S1A355 Outdoor Motor Skills-TrainClimbing Carriage
198 HW1-S1A365 Outdoor Motor Skills-TrainCrawl Tunnel
198 HW1-S1A359 Outdoor Motor Skills-TrainEngine
198 HW1-S1A356 Outdoor Motor Skills-TrainEntrance Carriage
198 HW1-S1A362 Outdoor Motor Skills-TrainLogs Balance
198 HW1-S1A364 Outdoor Motor Skills-TrainMushroom Stones Balance Bar
198 HW1-S1A596 Outdoor Motor Skills-TrainNet Bridge
198 HW1-S1A357 Outdoor Motor Skills-TrainRope Maze Carriage
198 HW1-S1A360 Outdoor Motor Skills-TrainRopes Balance
198 HW1-S1A363 Outdoor Motor Skills-TrainStepping Leaves Balance Bar
198 HW1-S1A361 Outdoor Motor Skills-TrainStumps Balance
113 PDWP-350118C32 PALM BAY COVE
113 PDWP-350032C32 PARADISE
135 MR-210006N PARK AVENUE
181 72-21056-114118 PAW HOPPER
181 72-21056-110113 PAW HOPPER
181 72-21057-118 PAW WEAVER
181 72-21057-111 PAW WEAVER
182 72-21058-112118 PAWSITIVE JUMP
182 72-21058-110113 PAWSITIVE JUMP
182 72-21064-112118 PAWSITIVELY TABLE
182 72-21064-110113 PAWSITIVELY TABLE
182 72-21061-112118 PAWTASTIC
182 72-21061-110113 PAWTASTIC
182 72-21060-112114118 PAWTASTIC TUNNEL
182 72-21060-110113 PAWTASTIC TUNNEL
76 TOT35CL-0001 Pebble Patch
208 72-21101 PERCUSSION PALS
82 TOT35CL-0012 PETUNIA
42 QSWP-350013N00 PIKES PEAK
42 QSWP-350013P00 PIKES PEAK
42 QSWP-350013N32 PIKES PEAK
42 QSWP-350013P32 PIKES PEAK
42 QSWP-350013N33 PIKES PEAK
42 QSWP-350013P33 PIKES PEAK
110 PDWP-350031C32 PINNWHEEL PARADE
188 WN-74-21107 PIVOT POINT
205 SR-21023-130 PLANE RIDER
25 QSWP-350010N00 PLAY TIME
25 QSWP-350010P00 PLAY TIME
25 QSWP-350010N11 PLAY TIME
25 QSWP-350010P11 PLAY TIME
25 QSWP-350010N12 PLAY TIME
25 QSWP-350010P12 PLAY TIME
25 QSWP-350010N13 PLAY TIME
25 QSWP-350010P13 PLAY TIME
55 QS72-21032 PLAYGROUND BALLS (SET OF 6)
14 QSWP-350062N00 POETER
14 QSWP-350062P00 POETER
14 QSWP-350062N11 POETER
14 QSWP-350062P11 POETER
14 QSWP-350062N12 POETER
14 QSWP-350062P12 POETER
14 QSWP-350062N13 POETER
14 QSWP-350062P13 POETER
80 TOT35CL-0010 POLLYWOGS
53 QSSR-21004 PONY RIDER
182 72-21062-114118 POOCH HOOPS
182 72-21062-110111 POOCH HOOPS
18 QSWP-350105N00 POTOMAC
18 QSWP-350105P00 POTOMAC
18 QSWP-350105N32 POTOMAC
18 QSWP-350105P32 POTOMAC
18 QSWP-350105N33 POTOMAC
18 QSWP-350105P33 POTOMAC
194 QB-210005 PROFESSORS QUBE
51 QSQB-21097-110 Q
51 QSQB-21097-114 Q
194 QB-210012P QUBE CLIMB AND SLIDE
51 QSQB-210001N QUIBEST
51 QSQB-210001P QUIBEST
56 QS72-22003 RAINBOW XYLOPHONE
66 WT35NS-0002-113118 RAPID RIDGE
159 PDAT50CL-0002C ROCHESTER
200 76AM-002 ROCK AND ROLL ON
140 WPPE-350013C ROCKET FLYER
205 SR-21021-129 ROCKET RIDER
21 QSWP-350046N00 ROCKY
21 QSWP-350046P00 ROCKY
21 QSWP-350046N32 ROCKY
21 QSWP-350046P32 ROCKY
21 QSWP-350046N33 ROCKY
21 QSWP-350046P33 ROCKY
122 PDWP-350083C00 ROVER RIDER
51 QSQB-210004N RUBY QUBE
51 QSQB-210004P RUBY QUBE
189 80-210013 RUSH RUNNER
17 QSWP-350101N06 SACRAMENTO
17 QSWP-350101P06 SACRAMENTO
17 QSWP-350101N11 SACRAMENTO
17 QSWP-350101P11 SACRAMENTO
17 QSWP-350101N12 SACRAMENTO
17 QSWP-350101P12 SACRAMENTO
17 QSWP-350101N13 SACRAMENTO
17 QSWP-350101P13 SACRAMENTO
136 PDWP-350039C32 SALMON
158 PDAT50CL-0020C SALT PETAL
96 PDWP-350121C33 SAN ANTONIO
131 SS-042-113 SAN TAN VILLAGE
207 SS-042-113 Sapling Swing
173 AT50PS-0001 SCALAWAGS
204 SR-21030 SEESAW
203 FS-WP0005C SENSORY STATION PAIR
203 FS-WP0002C SENSORY STATION QUAD SET
40 QSWP-350057N00 SEQUOIA
40 QSWP-350057P00 SEQUOIA
40 QSWP-350057N11 SEQUOIA
40 QSWP-350057P11 SEQUOIA
40 QSWP-350057N12 SEQUOIA
40 QSWP-350057P12 SEQUOIA
40 QSWP-350057N13 SEQUOIA
40 QSWP-350057P13 SEQUOIA
24 QSWP-350005N00 SHADY PINES
24 QSWP-350005P00 SHADY PINES

24 QSWP-350005N11 SHADY PINES
24 QSWP-350005P11 SHADY PINES
24 QSWP-350005N12 SHADY PINES
24 QSWP-350005P12 SHADY PINES
24 QSWP-350005N13 SHADY PINES
24 QSWP-350005P13 SHADY PINES
102 PDWP-350126C32 SHIFTING SANDS
19 QSWP-350002N00 SHININ BRIGHT
19 QSWP-350002P00 SHININ BRIGHT
19 QSWP-350002N11 SHININ BRIGHT
19 QSWP-350002P11 SHININ BRIGHT
19 QSWP-350002N12 SHININ BRIGHT
19 QSWP-350002P12 SHININ BRIGHT
19 QSWP-350002N13 SHININ BRIGHT
19 QSWP-350002P13 SHININ BRIGHT
147 WPPE-350003C00 SHREVEPORT
108 PDWP-350142C13 Single Arch Swing Frame
207 AS-350800-110 SINGLE BIKE RACK
58 QS72-21015-131 SKQUBE
51 OSQB-210002N SKQUBE
51 OSQB-210002P SKQUBE
35 QSYJ001367 SKY COPTER SAM
189 FS-CL3524-094BN SKY REACH ASCENT CLIMBER
143 WPPE-350020C SKY SEEKER
12 QSWP-350066N00 SKYLER
12 QSWP-350066P00 SKYLER
12 QSWP-350066N32 SKYLER
12 QSWP-350066P32 SKYLER
12 QSWP-350066N33 SKYLER
12 QSWP-350066P33 SKYLER
196 WS-210005C SLICKROCK
216 B-D006A SLOOP
115 PDWP-350130C11 SNAPDRAGON
208 72-21099 SOUNDWAVE
138 PDWP-350138C3A SPARKLECREST
19 QSWP-350025N00 SPEED RACER
19 QSWP-350025P00 SPEED RACER
19 QSWP-350025N11 SPEED RACER
19 QSWP-350025P11 SPEED RACER
19 QSWP-350025N12 SPEED RACER
19 QSWP-350025P12 SPEED RACER
19 QSWP-350025N13 SPEED RACER
19 QSWP-350025P13 SPEED RACER
188 PDFS-CL0028C SPIDER
186 WN-006C SPIDER CRAWL
189 75-21046 SPIN NEST
206 SR-21028-77 SPIRAL SHELL STANDING RIDER
56 QS72-22002 SPLIT RAINBOW XYLOPHONE
55 QS75-21003-110 STAND & SPIN
109 PDWP-350030C00 SUNDAZED
27 QSWP-350004N00 SUNNY DAYS
27 QSWP-350004P00 SUNNY DAYS
27 QSWP-350004N11 SUNNY DAYS
27 QSWP-350004P11 SUNNY DAYS
27 QSWP-350004N12 SUNNY DAYS
27 QSWP-350004P12 SUNNY DAYS
27 QSWP-350004N13 SUNNY DAYS
27 QSWP-350004P13 SUNNY DAYS
26 QSWP-350017N00 SUNNY STACK
26 QSWP-350017P00 SUNNY STACK
26 QSWP-350017N11 SUNNY STACK
26 QSWP-350017P11 SUNNY STACK
26 QSWP-350017N12 SUNNY STACK
26 QSWP-350017P12 SUNNY STACK
26 QSWP-350017N13 SUNNY STACK
26 QSWP-350017P13 SUNNY STACK
160 PDAT50CL-0005C SUNSET MOUNTAIN
154 PDAT50CL-0003C SUNSHINE SUMMIT
162 PDAT50CL-0021C SUNSWALLOW WILDERNESS
107 PDWP-350140C3A SWALE
86 PDWP-350098C11 SWEET MAY
186 WN-007C TANGLE PATH
208 72-21102 TEMPO TULIPS
182 72-21059-114118 TERRIER TUNNEL
182 72-21059-113110 TERRIER TUNNEL
55 PDWP-350089C13 TERRYS MAZE
47 FS-CL3524-118BN TETHERBALL SET
47 OSFS-CL00118 THE CHALLENGER
90 OSFS-CL0014P THE CHALLENGER
76-21116 THE LEARNING LODGE
187 WN-74-21033 THE RAMESSES
195 MR-210003C THE WINDOWS
122 PDWP-350135C12 THICKET
202 HW1-S101-1 THROUGH THE JUNGLE - SET OF 8
202 HW1-S101 THROUGH THE JUNGLE-SINGLE
104 PDWP-350127C33 TIGER LILY
65 WT35NS-0001-114123 TIMBER RUSH
23 QSWP-350006N00 TIMBER TRACKS
23 QSWP-350006P00 TIMBER TRACKS
23 QSWP-350006N11 TIMBER TRACKS
23 QSWP-350006P11 TIMBER TRACKS
23 QSWP-350006N12 TIMBER TRACKS
23 QSWP-350006P12 TIMBER TRACKS
23 QSWP-350006N13 TIMBER TRACKS
23 QSWP-350006P13 TIMBER TRACKS
42 QSWP-350053N00 TIME FLYER
42 QSWP-350053P00 TIME FLYER
42 QSWP-350053N11 TIME FLYER
42 QSWP-350053P11 TIME FLYER
42 QSWP-350053N12 TIME FLYER
42 QSWP-350053P12 TIME FLYER
42 QSWP-350053N13 TIME FLYER
42 QSWP-350053P13 TIME FLYER
89 76-21112 TIPY AGRES
84 PDWP-350090C13 TIPY-TOE
77 TOT35CL-0005 TOASTS-PLAY
91 76-21118 TOADSTOOL BURROW
182 72-21063-114118 TOTTER PAW
182 72-21063-110113 TOTTER PAW
164 PDAT50CL-0023C TRAIL TANGLE
54 QSHW1-S311-V01 TRAIN CRAWL TUNNEL-CARRIAGE
54 QSHW1-S310-V01 TRAIN CRAWL TUNNEL-ENGINE
205 SR-21027-123130 TRAVEL RIDER
85 PDWPPE-350001C15 TREBLE LEAF
190 PDFS-CL0024C TRIFECTA CHALLENGE
180 72-21017-111 TRIPLE BIKE RACK
186 WN-005C TRIPOD TRAVERSE
35 QSYJ001370-V01 TUGBOAT TOM
63 WT35NS-0003-77114122 TUMBLE TOWER
26 QSWP-350056N00 TURTLE ISLAND

26 QSWP-350056P00 TURTLE ISLAND
26 QSWP-350056N06 TURTLE ISLAND
26 QSWP-350056P06 TURTLE ISLAND
26 QSWP-350056N07 TURTLE ISLAND
200 QSWP-350056P07 TURTLE ISLAND
75-21014-114 TWIRL A WHIRL
185 WN-001C TWISTED MESH
120 PDWP-350077C15 TWISTER
200 75-21072 TWISTY WOO
178 63-21029 UP & OVER CLIMBE
187 WN-74-21018 VERTEX
193 PDQB-210010C VISIONARY
157 PDAT50CL-0019C WANDERWOOD CANOPY
182 72-21085-114118 WASTE STATION
182 72-21085-110111 WASTE STATION
177 LS-JSQC003 WAVY PARALLEL BARS
127 PDWPPE-350023C WAYWELL
205 SR-21020-114 WHALE RIDER
40 QSWP-350047N00 WIGGLE WORM
40 QSWP-350047P00 WIGGLE WORM
40 QSWP-350047N11 WIGGLE WORM
40 QSWP-350047P11 WIGGLE WORM
40 QSWP-350047N12 WIGGLE WORM
40 QSWP-350047P12 WIGGLE WORM
40 QSWP-350047N13 WIGGLE WORM
40 QSWP-350047P13 WIGGLE WORM
199 FS-SL72033N WIGGLY RACE
56 QSGP2-T072 WILD BUNCH
13 QSWP-350064N00 WILD RUN
13 QSWP-350064P00 WILD RUN
13 QSWP-350064N11 WILD RUN
13 QSWP-350064P11 WILD RUN
13 QSWP-350064N12 WILD RUN
13 QSWP-350064P12 WILD RUN
13 QSWP-350064N13 WILD RUN
13 QSWP-350064P13 WILD RUN
192 PDFS-CL0030C WILDER
137 WPPE-350012C WILDWOOD HEIGHTS
15 QSWP-350100N00 WILMINGTON
15 QSWP-350100P00 WILMINGTON
15 QSWP-350100N11 WILMINGTON
15 QSWP-350100P11 WILMINGTON
15 QSWP-350100N12 WILMINGTON
15 QSWP-350100P12 WILMINGTON
15 QSWP-350100N13 WILMINGTON
15 QSWP-350100P13 WILMINGTON
179 79-23002 WISE BACK STRETCH
178 FS-CL0020N WISE BAR - DUAL LEVEL
178 FS-CL0021N WISE BAR - TRI LEVEL
179 79-23001 WISE BENCH
56 QS78-21001 WISE BLACKBOARD
180 SA-21007-110 WISE CUSTOMIZABLE BENCH
206 SR-21015-77121 WISE DIG
34 QS76-21078 WISE DOC
34 QS76-21076 WISE FIRE HOUSE
34 QS76-21075 WISE GARDENER
150 BS35CS-0001 WISE KINGDOM
179 79-23004 WISE LIFT
56 QS78-21003 WISE PAINT BOARD
179 79-23003 WISE PUSH UP BARS
179 79-23005 WISE STEP UP
55 QSL-JSQC006N WISE TOSS
55 QSL-JSQC006P WISE TOSS
103 PDWP-350072C33 WISE TRAVELER
185 WN-003C WISE WEB
56 QS78-21002 WISE WHITE BOARD
58 QS72-21021-110 WISEBIN
58 QS72-21022-110 WISEBIN WITH RAIN COVER
204 SR-21010 WISEBOUNCE & BALANCE
53 QSSR-21005 WISESAW - DUO
204 SR-21012-113 WISESAW - QUAD
204 SR-21009 WISESAW - TRI
197 HW1-S1A353 WISETRAIN - CORNER SET
197 HW1-S1A352 WISETRAIN - REGULAR SET
191 PDFS-CL0012C WOBBLER WAY
41 QSWP-350048N00 WORLD TRAVELER
41 QSWP-350048P00 WORLD TRAVELER
41 QSWP-350048N06 WORLD TRAVELER
41 QSWP-350048P06 WORLD TRAVELER
41 QSWP-350048N07 WORLD TRAVELER
41 QSWP-350048P07 WORLD TRAVELER
39 QSWP-350007N00 YESTERYEARS
39 QSWP-350007P00 YESTERYEARS
39 QSWP-350007N11 YESTERYEARS
39 QSWP-350007P11 YESTERYEARS
39 QSWP-350007N12 YESTERYEARS
39 QSWP-350007P12 YESTERYEARS
39 QSWP-350007N13 YESTERYEARS
39 QSWP-350007P13 YESTERYEARS
25 QSWP-350060N00 ZAK
25 QSWP-350060P00 ZAK
25 QSWP-350060N11 ZAK
25 QSWP-350060P11 ZAK
25 QSWP-350060N12 ZAK
25 QSWP-350060P12 ZAK
25 QSWP-350060N13 ZAK
25 QSWP-350060P13 ZAK
85 PDWP-350097C12 ZOBY
189 FS-CL0040 ZOOMLINE ZIPPER
35 QSYJ001366 ZOOMSTER

Limited Warranty

Wisdom and World Klass Play warrants its products against structural failure due to defects in materials and workmanship for the warranty periods and material categories prescribed below

LIFETIME* Limited Warranty

Lifetime Limited Warranty on all aluminum posts, stainless steel fasteners, clamps, beams, and caps made of aluminum or steel against structural failure due to corrosion/natural deterioration or manufacturing defects, and on steel posts against structural failure due to material or manufacturing defects

15-Year Limited Warranty

On all steel arches, all plastic components, all aluminum and steel components not covered above, climbers, outdoor musical instruments, decks, and coatings (except Chain Ladders and Swing Chain) against structural failure due to material or manufacturing defects.

15-year Limited Warranty on Wood Parts

- Robinia wood parts
- Erythrophleum wood parts
- High-pressure laminate (HPL) parts
- Aluminum parts

10-Year Limited Warranty

On concrete products against structural failure due to natural deterioration or manufacturing defects. Does not cover minor chips, hairline cracks, or efflorescence.

- PVC coating for decks and stairs
- Pre-galvanized posts with painted top layer
- Painted surface on galvanized or aluminum metal parts
- Galvanized Steel Coating

10-year Limited Warranty on Wood Parts

- Wood-plastic composite (WPC) parts
- Larch, pine and other wood types

8-year Limited Warranty

On climbers and climbing cables against defects in materials or manufacturing defects.

- Rope and net constructions

2-Year limited Warranty

On all moving plastic or metal parts, rubber membranes, sunshade or sail solutions not falling into the category above.

5-year Limited Warranty

The following components are covered only against defects in materials or manufacturing

- Springs and ball bearing assemblies
- Graphical printing on transparent polycarbonate (PC) panels
- Concrete components
- Cable connections, cables, and mallets
- Polycarbonate panels.

Shade products are covered by a five (5)-year warranty against manufacturer defects or malfunctions arising during the applicable warranty period, including shade structure moving parts, cables, and materials, except where otherwise specifically excluded or listed separately in this warranty.

3-year Limited Warranty

On all other moving parts, including all swing seats and hangers, Mobius climber handholds, Chain Ladders, Swing Chain, trolleys and bumpers, Coil Spring (including gliders), belting material, resistance mechanisms, seesaws, etc., against failure due to corrosion/ natural deterioration or manufacturing defects

2-year Limited Warranty

On all moving plastic or metal parts, rubber membranes, sunshades, or sail solutions not falling into another category above.

Limitations:

This warranty applies to Wisdom and World Klass Play products for the applicable warranty periods specified for each product type and subject to the limitations set forth herein. All warranty periods begin on the date of Wisdom or World Klass Play's invoice and apply from the date of purchase by the original customer. This warranty covers defects in materials only.

Wisdom and World Klass Play's sole liability under this warranty is limited, at its discretion, to the repair or replacement of defective products at no charge. Defective components will be delivered and replaced by a Wisdom or World Klass Play-authorized professional installer free of charge. Repaired or replacement parts are warranted only for the remainder of the original warranty period. This warranty extends solely to the original Buyer/end user for products purchased from Wisdom and World Klass Play or an authorized reseller and is non-transferable.

This warranty applies only to products that are installed and maintained in strict accordance with Wisdom and World Klass Play's installation instructions and maintenance procedures. Wisdom and World Klass Play does not warrant that any specific color will remain available for any period of time and reserves the right to discontinue colors at its sole discretion.

This warranty does not cover the following:

- Cosmetic damage or flaws resulting from normal use, including but not limited to surface scratches, minor chips, hairline cracks, dents, marring, efflorescence, color fading, discoloration, corrosion or rust, fraying, or warping of recycled plastic lumber
- Products that have been modified, altered, or repaired by unauthorized parties
- Products not used as designed or intended, or products that have been misused
- Products with non-Wisdom or World Klass Play parts added or substituted
- Products removed from their original installation location and reinstalled elsewhere
- Damage resulting from excessive wear, vandalism, abuse, negligence, environmental conditions, extreme weather, or acts of God

Proper Installation & Maintenance:

The warranty only applies if Wisdom or World Klass Play products have been installed according to the instructions provided by Wisdom or World Klass Play and maintained correctly according to the associated Maintenance Manual. All warranty claims shall be accompanied by full documentation for proper installation and maintenance. The warranty for the components is dependent on those products being installed by a Wisdom or World Klass Play-trained and approved installer.

Warranty Exclusions and General Terms

This warranty does not cover damage resulting from accident, improper care, negligence, misuse, abuse, or vandalism, nor does it cover normal wear and tear, surface corrosion on metal components, discoloration, cosmetic defects, or other aesthetic issues. Natural changes in wood that occur over time are considered cosmetic in nature and are not covered by this warranty.

This warranty applies only if all play structures and/or equipment are installed in strict accordance with Wisdom and World Klass Play installation instructions and are properly maintained in compliance with the maintenance procedures provided by Wisdom and World Klass Play

Near Water Installations

Products installed in direct contact with chlorinated water or saltwater (including, but not limited to, waterparks), or products installed within 200 meters of a saltwater shoreline, are not covered by the Wisdom or World Klass Play warranty for defects caused by corrosion. Specially designed customized products that have been upgraded to corrosion class C4 based on ISO 12944 standard prior to delivery and are installed within 200 meters of the shoreline-provided they are not in direct contact with saltwater, exposed to salt spray, or installed in chlorinated water environments-shall be covered only for structural failure caused by corrosion (excluding moving parts), subject to the applicable warranty period for each product type, and in no event for longer than ten (10) years.

Due to the highly corrosive nature of coastal environments, a degree of corrosion and deterioration is considered normal wear. Products installed between 200 meters and 457 meters (500 yards) from a saltwater shoreline will be covered for defects caused by corrosion for only fifty percent (50%) of the standard warranty period, up to a maximum of five (5) years. Products installed in direct contact with saltwater or exposed to salt spray are not covered for corrosion-related defects under any circumstances.

Third-party Supplied Products & Services

Wisdom and World Class Play provide non-Wisdom and World Class Play branded products and installation services performed by certified third-party suppliers. This general Wisdom and World Class Play warranty does not apply to such non-Wisdom and World Class Play branded products and installation services, which may carry their own warranties. Wisdom and World Class Play will pass on information on such warranties where possible.

Freight & Warehousing

Global transport and logistics arranged by Wisdom and World Class Play appointed forwarder. Products/items are not to be stored outside waiting for installation and must be kept dry at all times.

- LIFETIME warranty is in effect for the lifetime of the product until the product is uninstalled and/or taken out of use. In addition, Wisdom and World Class Play general terms and delivery conditions apply and supplement this warranty.

THE FOREGOING LIMITED WARRANTY IS THE SOLE AND EXCLUSIVE WARRANTY FOR SELLER'S PRODUCTS, AND IS IN LIEU OF ALL OTHER WARRANTIES, EXPRESS OR IMPLIED.



ISO 9001/ISO 14001

Industry certification processes issued by the International Organization for Standardization. ISO 9001 is used to measure manufacturing standards and to certify company compliance with quality management systems covering design, development, production, installation, inspection and testing. ISO 14001 also known as the green certification, specifies the requirements of an environmental management system (EMS). An EMS is a systemic approach to handling environmental issues within an organization. World Class Play is ISO 9001 and ISO 14001 certified

ASTM

ASTM International is an independent and world renowned developer of technical standards utilized in testing a multitude of products. ASTM's F15.29 committee met regularly for over a decade in the continual development of the F1487 Standard Consumer Safety Performance Specifications for Playground Equipment for Public Use. The original standard, F1487-93 was published in 1993 and subsequently replaced by the current version F1487-17. Published February 2017. Throughout this catalog we state ASTM Use Zones in dimensional form per the ASTM F1487 Standard Consumer Safety Performance Specifications for Playground Equipment for Public Use, which are minimum dimensions. Consideration should be given to the number of users and their circulation patterns.

ASTM INTERNATIONAL
100 Barr Harbor Drive, PO Box C700
West Conshohocken, PA 19428-2959
Website: www.astm.org
E-mail address: service@astm.org

CPSC

The Consumer Product Safety Commission is an independent agency within the United States Federal Government with the authority to inform the public of current product safety performance information and recommended practices. The CPSC first published their guidelines for public playgrounds in 1981 and have updated their publication several times since then. The current CPSC Handbook for Public Playground Safety, publication #325, is an excellent guide for owners and operators of public play environments.

U.S. Consumer Product Safety Commission
Washington, DC 20207
Website: www.cpsc.org
E-mail address: info@cpsc.gov

CSA

The Canadian Standards Association is an independent and renowned developer of technical standards utilized in evaluating a multitude of products. The CSA standard on Children's Playspaces and Equipment 1990 edition was revised in March, 2020 and is now officially CAN/CSA-Z614:20, entitled Children's Playground Equipment and Surfacing. The CSA standard is significantly harmonized with the ASTM F1487-11 standard.

Canadian Standards Association
5060 Spectrum Way Suite 100
Mississauga, Ontario L4W 5N6
Website: www.csa.ca

ADA

Access Board (The United States Architectural and Transportation Barriers Compliance Board) has completed Accessibility Guidelines for Play Facilities as set forth in the Americans with Disabilities Act of 1990. The final rules, fact sheets and analysis are all available at the Department of Justice.

Access Board
1331 F street, NW
Washington, DC 20004-1111
Website: www.access-board.gov
E-mail address: greenwell@access-board.gov



TÜV America

Product Service, an international testing and certification organization is a European Union Notified and Competent Body providing services which include product testing and certification. The highly visible TÜV-Mark demonstrates to customers that safety testing and certification has been completed by an independent third-party organization. The "S" pictogram combined with the statements "Safety tested", "EN 1176" and "Production monitored" indicate that these products have passed a comprehensive testing procedure based upon the European Harmonized Standard for Commercial Playground Equipment, EN 1176 and that the World Class Play production plant is regularly monitored by TÜV. Contact your international World Class Play distributor for complete EN 1176 compliance details.

TÜV SÜD America Inc.
10 Centennial Drive
01960 Peabody, MA
Website: www.tuvsud.com/en-us
E-mail: info-us@tuvsud.com

IPEMA

In the interest of playground safety, the International Play Equipment Manufacturers Association (IPEMA) provides a Third Party Certification program whereby a designated independent laboratory, TÜV SÜD America Inc., (TÜV), validates an equipment manufacturer's certification of compliance to the ASTM F1487 Standard Consumer Safety Performance Specification for Playground Equipment for Public Use, except sections 7.1.1, 10, 13.1.1, 13.1.2, 13.2, and 13.3; to CAN/CSA Z614 Children's Playground Equipment and Surfacing, except clauses 10 and 11; or both. A list of current validated products may be viewed at www.ipema.org